

PGP ULTRA INSTALLATION:

The PGP Ultra pop-up sprinkler should be installed at finished grade as shown in the illustration (Fig. 1).

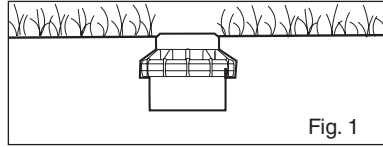

Fig. 1

Arc Adjustments:

Adjustable heads are preset to approximately 180°. Sprinklers may be adjusted with water on or off. It is recommended that initial adjustments be made before installation.

- Using the palm of your hand, rotate the nozzle turret counterclockwise to the left stop to complete any interrupted rotation cycle (Fig. 2).
- Rotate the nozzle turret clockwise to the right stop. This is the fixed side of the arc. The nozzle turret must be held in this position for arc adjustments. The right stop does not change.

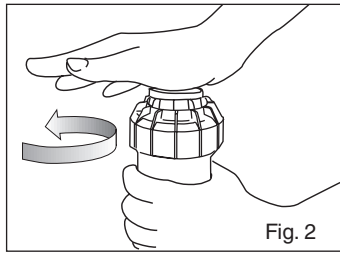

Fig. 2

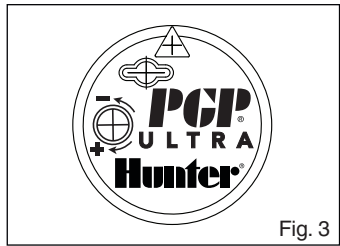

Fig. 3

To Increase the Arc:

- Insert the plastic key end of the Hunter wrench into the adjustment socket (Fig. 3 & 4).
- While holding the nozzle turret at the right stop, turn the wrench clockwise. Each full 360° turn of the wrench will increase the arc 90°.
- Adjust to any arc between 50° and 360° (Fig. 5).
- The wrench will stop turning, or there will be a ratcheting noise, when the maximum arc of 360° (full circle) has been reached.
- When set to 360, the sprinkler will rotate continually counterclockwise.**

To Decrease the Arc:

- Insert the plastic key end of the Hunter wrench into the adjustment socket (Fig. 3 & 4).
- While holding the nozzle turret at the right stop, turn the wrench counterclockwise. Each full 360° turn of the wrench will decrease the arc 90°.
- Adjust to any arc between 50° and 360° (Fig. 5).
- The wrench will stop turning, or there will be a ratcheting noise, when the minimum arc of 50° has been reached.

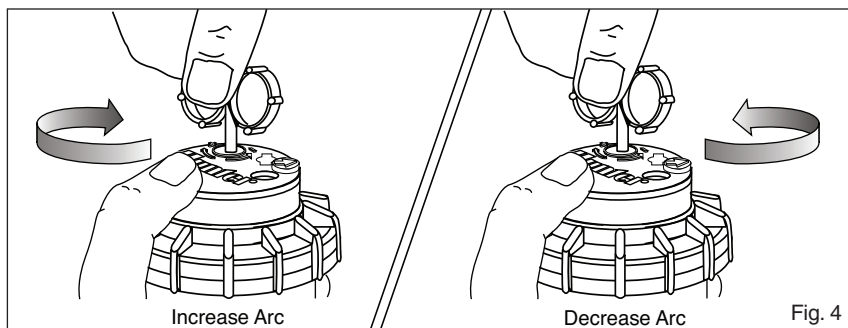

Fig. 4

Note: It is not necessary to disassemble the sprinkler to make adjustments.

RADIUS / DISTANCE OF THROW

Insert the steel hex end of the Hunter wrench into the radius adjustment screw (Fig. 6). Turn the screw clockwise (into the stream of water) to decrease the radius, or counterclockwise to increase the radius. Radius can be reduced up to 25%.

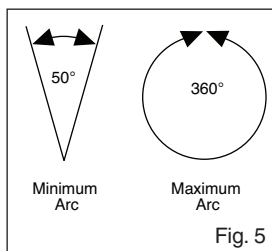

Fig. 5

PRECIPITATION RATE ADJUSTMENT

If you have excessively wet or dry areas, you can change the nozzle in the sprinkler to increase or decrease the precipitation rate. For dry areas, install a larger nozzle. For wet areas, install a smaller nozzle.

DRAIN CHECK VALVE

All Hunter sprinklers are available with a factory-installed drain check valve. The drain check valve prevents low-head drainage with elevation changes up to 10'. To order, specify PGP-00-CV or PGP-04-CV. All PGP-12 sprinklers come standard with a drain check valve. If a check valve is added to the standard PGP-04 in the field, the elevation check height will be approximately 4'.

RECLAIMED ID

All Hunter rotors are available with a purple rubber cover permanently attached. The purple cover shows that reclaimed water is being used for the project, which promotes safety on the job site.

NOZZLE INSTALLATION

- Insert the plastic key end of the Hunter wrench into the lifting socket of the sprinkler and turn 90°. Pull the riser up to gain access to the nozzle socket (Fig. 8).
- Using the hex key of the Hunter wrench, turn the radius adjustment screw (Fig. 6) counterclockwise to be sure it is not blocking the nozzle socket opening. If a nozzle is already installed, it can

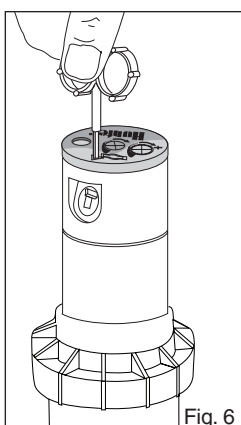

Fig. 6

be removed by backing out the adjustment screw and turning on the water, or by pulling outward on the nozzle "ears" with a pair of needle-nosed pliers.

- Slip the desired nozzle into the nozzle socket (Fig. 7). Note that the socket is angled up 25°. The "ears" should be adjusted so that the nozzle range screw threads directly down between them. Then tighten the nozzle range screw. The raised bump with an arrow on the rubber cover will always indicate the location of the nozzle and direction of water flow when the sprinkler is retracted.

ALIGNING THE RIGHT (FIXED) SIDE OF ARC

If the right side of the arc is not properly aligned, the results may be a wet walkway or a dry turf area. The right side arc can easily be realigned. One way to realign the right stop is to turn the whole sprinkler body assembly and the fitting below it, left or right to the desired position. This may require temporary removal of the soil around the sprinkler to allow you to grip the sprinkler housing.

Another way to reset the right arc is to unscrew the body cap counterclockwise and remove the internal assembly from the body. Once removed, rotate the nozzle turret to the right stop, screw the internal assembly back into the body with the nozzle aligned to the right side of the area you want irrigated (Fig. 9). At this point you have realigned the right arc stop, and you can adjust the left arc to an appropriate setting.

Note: It is not necessary to dig up and remove the whole sprinkler to realign the right arc.

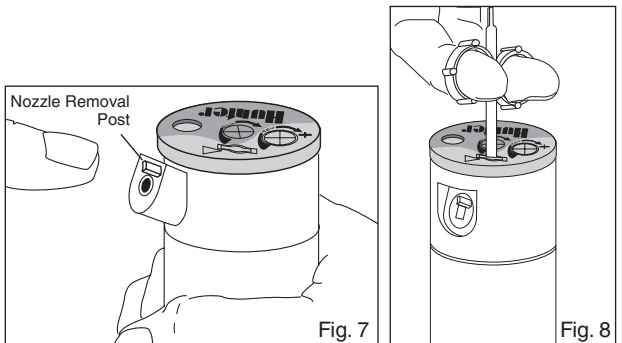

Fig. 7

Fig. 8

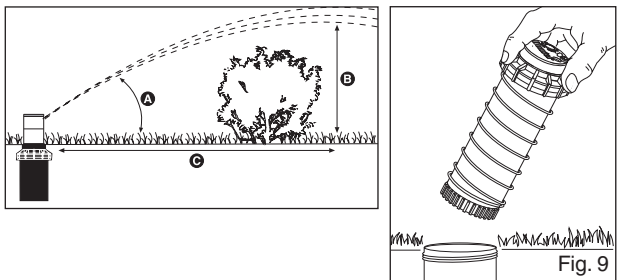

Fig. 9

Model	Nozzle No.	Pressure in PSI	Degrees of Trajectory	Max Height of Spray	Distance from head to Max Height
PGP Ultra Blue	1.5	45	25	8'	23'
	2.0	45	25	8'	23'
	2.5	45	25	9'	26'
	3.0	45	25	10'	28'
	4.0	45	25	11'	30'
	5.0	45	25	11'	30'
	6.0	55	25	12'	32'
	8.0	55	25	13'	32'
PGP Ultra Low Angle	2.0LA	50	13	5'	22'
	2.5LA	50	13	4'	22'
	3.5LA	50	13	4'	22'
	4.5LA	50	13	4'	22'
PGP Ultra Short Radius	.50	50	15	5'	8'
	1.0	50	14	6'	9'
	2.0	50	3	1'	6'
PGP Ultra Short Radius	.75	50	22	7'	13'
	1.5	50	18	7'	13'
	3.0	50	8	1'	6'

NON-REVERSING 360

This PGP Ultra sprinkler is designed as a part- and full-circle in one model. When the sprinkler is adjusted to the full-circle position, the sprinkler will rotate in a continuous counterclockwise direction. This saves everyone from stocking additional full-circle only models while efficiently irrigating the landscapes.

NON-STRIPPABLE BACKDRIVE

This PGP Ultra sprinkler is designed with an internal device that prevents damage to the internal gear drive if it should be turned by vandals. This important feature works when the nozzle turret is turning in either direction. This makes the sprinkler very durable in all applications.

AUTO ARC RETURN

This PGP Ultra sprinkler is designed with an internal device that re-aligns the arc if it is turned by vandals. This important feature works when the nozzle turret is turning in either direction.

When forced outside of the originally set arc, the sprinkler takes the shortest path back to the pattern without going completely around. This saves the non-irrigated areas from getting wet! Always a good thing!

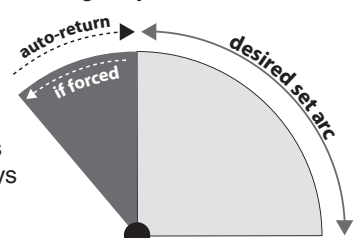

PGP® ULTRA/I-20 PERFORMANCE CHARTS



BLUE/GREY NOZZLES P/N 782900

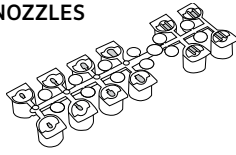

BLACK SHORT RADIUS NOZZLES P/N 466100

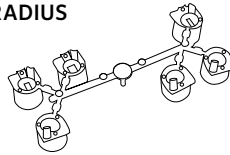

MPR MATCHED PRECIPITATION RATE NOZZLES

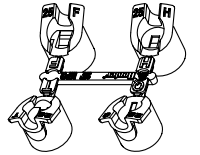

PGP® ULTRA / I-20 BLUE STANDARD NOZZLE PERFORMANCE DATA

Nozzle	Pressure PSI	Radius ft.	Flow GPM	Precip in/hr	
				■	▲
1.5 Blue	25	29	1.2	0.27	0.32
	35	31	1.4	0.28	0.32
	45	31	1.5	0.30	0.35
	55	32	1.8	0.34	0.39
2.0 Blue	25	33	1.4	0.25	0.29
	35	33	1.7	0.30	0.35
	45	34	2.0	0.33	0.38
	55	34	2.1	0.35	0.40
2.5 Blue	25	33	1.7	0.30	0.35
	35	35	2.1	0.33	0.38
	45	35	2.5	0.39	0.45
	55	35	2.6	0.41	0.47
3.0 Blue	25	35	2.2	0.35	0.40
	35	36	2.7	0.40	0.46
	45	38	3.0	0.40	0.46
	55	39	3.4	0.43	0.50
4.0 Blue	25	37	3.0	0.42	0.49
	35	39	3.5	0.44	0.51
	45	40	4.0	0.48	0.56
	55	41	4.5	0.52	0.60
5.0 Blue	25	37	3.7	0.52	0.60
	35	39	4.5	0.57	0.66
	45	42	5.0	0.55	0.63
	55	42	5.7	0.62	0.72
6.0 Blue	25	38	4.3	0.57	0.66
	35	40	5.6	0.67	0.78
	45	43	6.0	0.62	0.72
	55	44	6.7	0.67	0.77
8.0 Blue	25	37	6.0	0.84	0.97
	35	41	7.0	0.80	0.93
	45	44	8.0	0.80	0.92
	55	46	9.0	0.82	0.95
Grey	65	44	7.3	0.73	0.84
	65	41	4.8	0.55	0.63
	65	35	2.9	0.46	0.53
	65	35	2.9	0.46	0.53

PGP ULTRA / I-20 BLACK SHORT RADIUS NOZZLE PERFORMANCE DATA (18'/25')

Nozzle	Pressure PSI	Radius ft.	Flow GPM	Precip in/hr	
				■	▲
.50 SR Black	30	17	0.36	0.24	0.28
	40	17	0.43	0.29	0.33
	50	18	0.50	0.30	0.34
	60	19	0.57	0.30	0.35
1.0 SR Black	30	17	0.78	0.52	0.60
	40	17	0.90	0.60	0.69
	50	18	1.00	0.59	0.69
	60	19	1.10	0.59	0.68
2.0 SR Black	30	17	1.40	0.93	1.08
	40	17	1.70	1.13	1.31
	50	18	2.00	1.19	1.37
	60	19	2.20	1.17	1.35
.75 SR Black	30	23	0.58	0.21	0.24
	40	24	0.68	0.23	0.26
	50	25	0.75	0.23	0.27
	60	26	0.83	0.24	0.27
1.5 SR Black	30	23	1.10	0.40	0.46
	40	24	1.30	0.43	0.50
	50	25	1.50	0.46	0.53
	60	26	1.60	0.46	0.53
3.0 SR Black	30	23	2.50	0.91	1.05
	40	24	2.70	0.90	1.04
	50	25	3.00	0.92	1.07
	60	26	3.10	0.88	1.02

PGP® ULTRA / I-20 MPR-25 RED NOZZLE PERFORMANCE DATA

Nozzle	Pressure PSI	Radius ft.	Flow GPM	Precip in/hr	
				■	▲
90° Red	25	23	0.74	0.54	0.62
	35	24	0.88	0.59	0.68
	45	25	1.00	0.62	0.71
	55	25	1.11	0.68	0.79
120° Red	25	23	1.21	0.55	0.63
	35	24	1.21	0.61	0.70
	45	25	1.38	0.64	0.74
	55	25	1.53	0.71	0.82
180° Red	25	23	1.44	0.52	0.61
	35	24	1.73	0.58	0.67
	45	25	1.98	0.61	0.70
	55	25	2.21	0.68	0.79
360° Red	25	23	2.78	0.51	0.58
	35	24	3.34	0.56	0.64
	45	25	3.82	0.59	0.68
	55	25	4.25	0.65	0.76
65	25	25	4.63	0.71	0.82
	35	25	4.63	0.71	0.82
	45	25	4.63	0.71	0.82
	55	25	4.63	0.71	0.82

GREEN HIGH FLOW NOZZLES P/N 44800

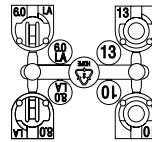

PGP ULTRA / I-20 GREEN HIGH FLOW NOZZLE PERFORMANCE DATA

Nozzle	Pressure PSI	Radius ft.	Flow GPM	Precip in/hr	
				■	▲
10 Dk. Green	40	42	8.4	0.92	1.06
	50	43	9.5	0.99	1.14
	60	45	10.5	1.00	1.15
	70	47	11.4	0.99	1.15
13 Dk. Green	40	43	10.9	1.13	1.31
	50	44	12.3	1.22	1.41
	60	45	13.6	1.29	1.49
	70	47	14.8	1.29	1.49
6.0 LA Dk. Green	30	31	4.2	0.84	0.97
	40	35	5.0	0.79	0.91
	50	37	5.8	0.82	0.94
	60	39	6.3	0.80	0.92
8.0 LA Dk. Green	40	37	6.7	0.94	1.09
	50	39	7.7	0.97	1.13
	60	41	8.5	0.97	1.12
	70	41	9.2	1.05	1.22

PGP ULTRA / I-20 MPR-30 LT. GREEN NOZZLE PERFORMANCE DATA

Nozzle	Pressure PSI	Radius ft.	Flow GPM	Precip in/hr	
				■	▲
90° Lt. Green	25	29	1.03	0.47	0.54
	35	30	1.23	0.53	0.61
	45	30	1.40	0.60	0.69
	55	30	1.56	0.67	0.77
120° Lt. Green	25	29	1.34	0.46	0.53
	35	30	1.62	0.52	0.60
	45	30	1.85	0.59	0.69
	55	30	2.06	0.66	0.76
180° Lt. Green	25	29	2.15	0.49	0.57
	35	30	2.59	0.55	0.64
	45	30	2.96	0.63	0.73
	55	30	3.30	0.71	0.82
360° Lt. Green	25	29	3.60	0.77	0.89
	35	30	4.24	0.49	0.56
	45	30	5.08	0.54	0.63
	55	30	5.78	0.62	0.71
65	25	30	6.39	0.68	0.79
	35	30	6.92	0.74	0.85
	45	30	6.92	0.74	0.85
	55	30	6.92	0.74	0.85

PGP ULTRA / I-20 GRAY LOW ANGLE NOZZLE PERFORMANCE DATA

Nozzle	Pressure PSI	Radius ft.	Flow GPM	Precip in/hr	
				■	▲
2.0 LA Gray	30	25	1.6	0.49	0.57
	40	27	1.9	0.50	0.58
	50	28	2.1	0.52	0.60
	60	30	2.3	0.49	0.57
2.5 LA Gray	30	27	2.1	0.55	0.64
	40	30	2.5	0.53	0.62
	50	33	2.8	0.49	0.57
	60	35	3.0	0.47	0.54
3.5 LA Gray	30	29	2.8	0.64	0.74
	40	32	3.1	0.58	0.67
	50	35	3.5	0.55	0.64
	60	37	3.8	0.53	0.62
4.5 LA Gray	30	29	3.4	0.78	0.90
	40	32	3.9	0.73	0.85
	50	35	4.4	0.69	0.80
	60	37	4.7	0.66	0.76

PGP ULTRA / I-20 MPR-35 BEIGE NOZZLE PERFORMANCE DATA

Nozzle	Pressure PSI	Radius ft.	Flow GPM	Precip in/hr	
				■	▲
90° Beige	25	32	1.40	0.53	0.61
	35	34	1.67	0.56	0.64
	45	35	1.92	0.60	0.70
	55	35	2.13	0.67	0.77
120° Beige	25	32	1.77	0.50	0.58
	35	34	2.15	0.54	0.62
	45	35	2.46	0.58	0.67
	55	35	2.74	0.65	0.75
180° Beige	25	32	2.99	0.70	0.81
	35	34	3.33	0.55	0.64
	45	35	3.81	0.60	0.69
	55	35	4.23	0.66	0.77
360° Beige	25	32	4.62	0.73	0.84
	35	34	5.36	0.50	0.58
	45	35	6.62	0.55	0.64
	55	35	7.58	0.60	0.69
65	25	35	8.43	0.66	0.76
	35	35	9.18	0.72	0.83
	45	35	9.18	0.72	0.83
	55	35	9.18	0.72	0.83

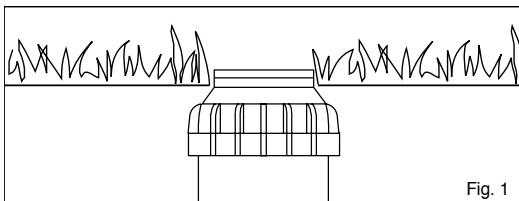

Fig. 1

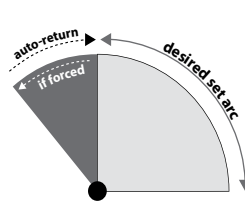

Fig. 2

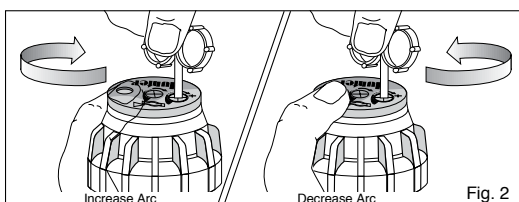

Fig. 3

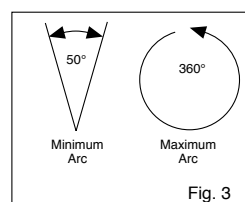

Fig. 4

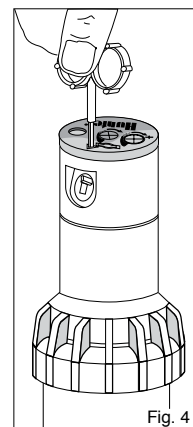

Fig. 5