

# ACC

## Advanced Commercial Controller

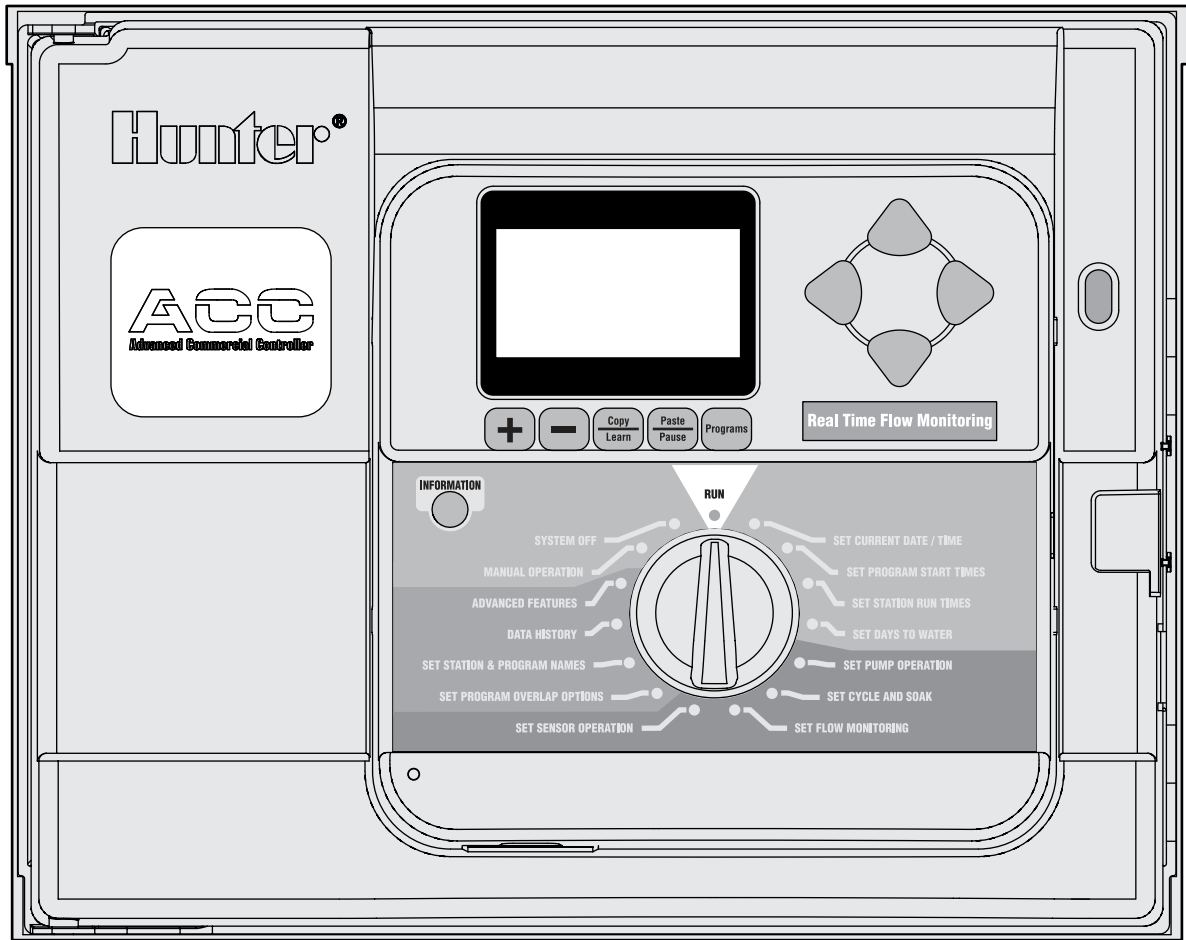

### Owner's Manual, Installation, and Programming Instructions for ACC and ACC Decoder Controllers

- ACC-1200 12 Station Controller, 42 Station Capacity, Metal Cabinet
- ACC-1200-PP 12 Station Controller, 42 Station Capacity, Plastic Pedestal
- ACC-99D 2-Wire Decoder Controller with 99 Station Capacity, Metal Cabinet
- ACC-99D-PP 2-Wire Decoder Controller with 99 Station Capacity, Plastic Pedestal

**Hunter**<sup>®</sup>



# TABLE OF CONTENTS

<b>ACC INTERFACE AND KEY COMPONENTS</b>	2
<b>WIRING COMPARTMENT INTERIOR</b>	3
<b>METAL CABINET, WALL MOUNT INSTALLATION</b>	4
<b>CONNECTING AC MAIN POWER, WALL MOUNT CABINET</b>	5
<b>METAL CABINET OPTIONAL PEDESTAL INSTALLATION</b>	6
Connecting the Metal Pedestal Main AC Power	6
<b>PLASTIC PEDESTAL INSTALLATION</b>	6
<b>CONCRETE BASE INSTALLATION</b>	7
<b>CONNECTING PLASTIC PEDESTAL AC MAIN POWER</b>	8
120 VAC Connection	8
230 VAC Connection	8
<b>CONNECTING EARTH GROUND (ALL CONFIGURATIONS)</b>	10
<b>INSTALLING STATION MODULES</b>	11
Output Modules (ACM600, AGM600)	11
Connecting the Valve Wires	12
Decoder Output Module (ADM99)	12
Connecting Decoder Output Path Wires	12
<b>KEY CONNECTIONS</b>	13
<b>24 VAC TEST TERMINAL</b>	14
<b>CONNECTING THE MASTER VALVE(S) AND/OR PUMP START RELAY(S)</b>	14
<b>CONNECTING A RAIN OR FREEZE SHUT OFF DEVICE</b>	14
<b>CONNECTING THE HUNTER FLOW SENSOR</b>	15
<b>CONNECTING OTHER FLOW SENSORS</b>	16
<b>ICR REMOTE CONTROL</b>	16
Multiple Stations simultaneously	16
<b>CONNECTING TO IMMS</b>	17
Dial-up telephone (ACC-COM-POTS)	17
Cellular/GSM (ACC-COM-GSM, GSM-E)	18
UHF Radio	18
<b>POWER FAILURES</b>	18
<b>QUICK START</b>	18
<b>CONTROLLER PROGRAMMING AND OPERATION</b>	19
Using the Information Button	19
Setting Current Date and Time	20
Setting Program Start Times	20
To Set Program Start Times	20
Stacked Start Times	20
Overlapping Start Times	20
Multiple Start Times	21
No-Water Window	21

Setting Station Run Time Duration	21
Changing Seasonal Adjust	22
Using the Global Setting	22
Using a Program Specific Setting (set Season Adjust by Program)	22
Timed Delay between Stations	22
Setting Days to Water	22
Set Days to Water	22
Day of the Week Watering	23
Interval Watering	23
Odd/Even Watering	23
Setting Pump and Master Valve Operation	23
Set Pump and Master Valve Operation	24
Changing from Normally Closed to Normally On and Location of P/MV	24
Setting Station Cycle and Soak Durations	24
Set Station Cycle and Soak Durations	24
Cycle and Soak Summary	24
<b>SETTING FLOW MONITORING</b>	25
Step 1: Select The Flow Sensor	25
Step 2: Viewing Real-Time Flow	26
Step 3: Preparing for Flow Learning	27
Step 4: Learning the Flow	27
Step 5: Review And Edit Flow	28
Flow Alarms	28
Alarm Logs	29
Tips on Flow Alarms	30
<b>SETTING CLIK™ SENSOR OPERATION</b>	30
Set Sensor Operation	31
<b>SENSOR ALARMS (CLIK SENSORS SEN 1–4 ONLY)</b>	32
Clear Message	32
Sensor Locations	33
Sensor Locations	35
<b>SETTING PROGRAM OVERLAP OPTIONS</b>	36
Option One: Stack or Overlap	36
Option Two: SmartStack™	36
Option Three: SSG/SmartStack™	36
Set Station & Program Names	37
Assign Contact Information	37
<b>DATA HISTORY</b>	38
Name a Program (Up to 12 Characters and Spaces)	38
Name a Station (Up to 12 Characters and Spaces)	38
View Flow Totals	38
View Alarm Logs	38
View Controller Logs	39

View Station Logs	39
Advanced Features	39
View Version and Station Size	40
<b>COMMON ALARM (ATTENTION) MESSAGES</b>	41
Overcurrent	41
Overflow	42
Power Outage/Power Restored	43
Underflow	43
<b>EXTENDED FEATURES</b>	43
Contrast Adjustment	43
No Water Window	44
To set a No Water Window	44
No Water Window rules	44
Delay Between Stations	45
To set a Delay	45
P/MV Style (Normally Closed/Normally On)	45
To change the Normal condition of P/M outputs	46
Setting the Flow Sensor Size and Type	46
Additional settings for OTHER	47
SSG (Simultaneous Station Group) Setup	47
EDIT AN SSG	48
ADDING AN SSG	49
DELETING AN SSG	49
SSG FLOW DATA	49
SSG Rules	49
Custom Manual Program Setup	50
Custom Manual Rules	50
Start a Custom Manual	51
Test Program	51
Run a Test Program	51
Easy Retrieve™ Backup	52
<b>ONE TOUCH MANUAL START</b>	53
<b>MANUAL OPERATION DIAL POSITION</b>	53
<b>SYSTEM OFF</b>	54
<b>RAIN OFF</b>	55
<b>RESET</b>	55
<b>DECODER OPERATIONS (ACC99D VERSIONS)</b>	56
Connecting the 2-Wire Paths	56
Status Lights (ADM-99 Output Module)	57
Decoder Programming	57
Program Decoder Stations	57
Decoder Pump/Master Valves	59
ICD-SEN Sensor Decoder Setup	59

Setup Overview	60
Connect an HFS Meter to an ICD-SEN	60
Connect a Clik Sensor to an ICD-SEN	60
SEN/DEC Setup	60
<b>OTHER SPECIAL DECODER FUNCTIONS (ADVANCED FEATURES)</b>	62
View Decoder Config	62
Display ADM Current	63
Sen/Dec Alarms	63
<b>ACC SOLAR SYNC</b>	64
Preparation	64
Facepack Version	64
Master Module	64
Base Run Times	64
Installation	65
Setup	65
Sensor Test	66
Assign Programs	67
Sensor Shutdown Programming	67
Sensor Mapping	67
Sensor Shutdown by Program	68
Operation & Adjustment	68
Making Adjustments	69
Increase or Decrease Watering	69
Check Run Times	69
Tracking the Adjustment History (Controller Log)	69
Solar-Sync Sensor Alarms	70
S-Sync Comm Failure	71
<b>IMMS-ET AND THE ACC CONTROLLER</b>	72
ET Setup and Operations	72
ET Functions	72
ET Operation	72
ET Sensor Check	73
View ET Sensors	73
ET Alarm Setup	73
<b>EVENT MODE OPTIONS (AGC, SURVEYOR)</b>	75
<b>CENTRAL SOFTWARE AND ACC-AGC COMMUNICATION MODULES</b>	77
Theory of Operation	77
UHF Radio	77
Hardwired Cable	78
<b>COMMUNICATION MODULE INSTALLATION FOR WALL MOUNT CONTROLLER</b>	78
Radio Installation, additional steps	78
Radio Connections, additional steps	79

<b>COMMUNICATION MODULE INSTALLATION FOR PLASTIC PEDESTAL CONTROLLER</b>	79
Radio Installation, additional steps	79
<b>SETUP AND ADDRESSING THE COM MODULE</b>	80
Set the Controller Address	80
Other Com Setup Functions	80
Master Controller	80
Contrast	80
Radio Type	80
Last MR Cmd (Radio Only)	80
DTMF Wait (Radio Only)	80
MR Default Run Time (Radio Only)	81
Modem Type	81
Country Code	81
HWIM	81
Enter Diagnostics	81
Communications Status display [MOD RAD HW]	81
Radio Tone Test	82
Ping Test	82
Ping Hub	82
Soft Reset	82
Total Reset	82
Operating the Com Module	82
<b>TROUBLESHOOTING</b>	83
<b>ACC/AGC LOG MESSAGES</b>	84
Alarm Log messages	84
Alarm Log, Missed Irrigation “Mode” Labels	84
Alarm Log, “Reason” Labels	85
Controller Logs	85
Station Logs	86
<b>SPECIFICATIONS</b>	87
Dimensions	87
Electrical	87
Transformer Input	87
Transformer output	87
Cleaning	87
Features & General Specifications	87
<b>PARTS</b>	88
Wall Mount Controllers (ACC1200, ACC99D)	88
Communication Modules and Parts	88
Pedestal Controllers (ACC1200PP, AGC1200PP, ACC99DPP, AGC99DPP)	89
ACC/AGC Central System Components (ACC1200, ACC99D, ACC1200PP, AGC1200PP, ACC99DPP, AGC99DPP)	89
<b>INDEX</b>	90

## INTRODUCTION

The ACC controller, in its many modular configurations, is Hunter's premium industrial-grade controller for high-performance irrigation control. Its primary purpose is to operate 24 VAC irrigation solenoids or low-draw solid state relays for specific durations at specific times. It can also be connected to various sensors, providing automatic shutdown and notification in case of emergencies, and actual flow records and responses in real time.

With plug-in Com and other modules, the ACC can also communicate with a computerized central control system via hardwired cable, radio, dial-up telephone, or cellular modem. ACC is also prewired to accept Hunter wireless remote controls.

- This product should not be used for anything other than what is described in this document.
- This product should only be serviced by trained and authorized personnel.
- This product is designed for continuous outdoor use above sea level to 15,000 feet/4.5 km at temperatures 32–122° F.
- These units have an IPX4 rating.
- This controller is not intended for use by young children or infirm persons without supervision; young children should be supervised to ensure that they do not play with the appliance.
- **Hunter Technical Support: 1 (800) 733-2823**



# ACC INTERFACE AND KEY COMPONENTS .....

1. **LCD Display** – Backlit, adjustable contrast display (re-lights when any button is pressed)
2. **+ Button** – Increases flashing value, depending on function
3. **- Button** – Decreases flashing value. Most items in ACC screens “wrap” so that you can continue in either direction through all the choices
4. **Copy/Learn Button** – Copies a time or value in a flashing field, for pasting into similar fields. Also used to learn typical flow (when a flow sensor has been installed)
5. **Paste/Pause Button** – Pastes a copied time or value into a new field. Also used as Pause/Resume feature during watering, shuts off devices for 30 minutes or until resumed
6. **Programs Button** – Selects one of the automatic Programs (A-F), starts Test program, allows Reset (with Reset button)
7. **Up and Down Arrow Buttons** – Used to move up and down through adjustable functions in various screens, and to select higher or lower numbered items
8. **Left and Right Buttons** – Used to move left and right in some screens
9. **Information Button** – Lights display, and provides instant help and other information, depending on dial position. Also used to access Extended Features, when held down while turning to specific dial positions
10. **Programming Dial** – Used to access all functions of ACC. The most basic automatic watering can be set up in the first 4 dial positions
11. **Reset Button** – Recessed switch erases some or all memory when combined with pressing specific buttons
12. **Facepack Release Button** – Hold down while removing facepack from inner door panel
13. **Door Grip** – Convenient finger grip for opening inner door
14. **Logo Badge** – Removable for installation of optional communications modules

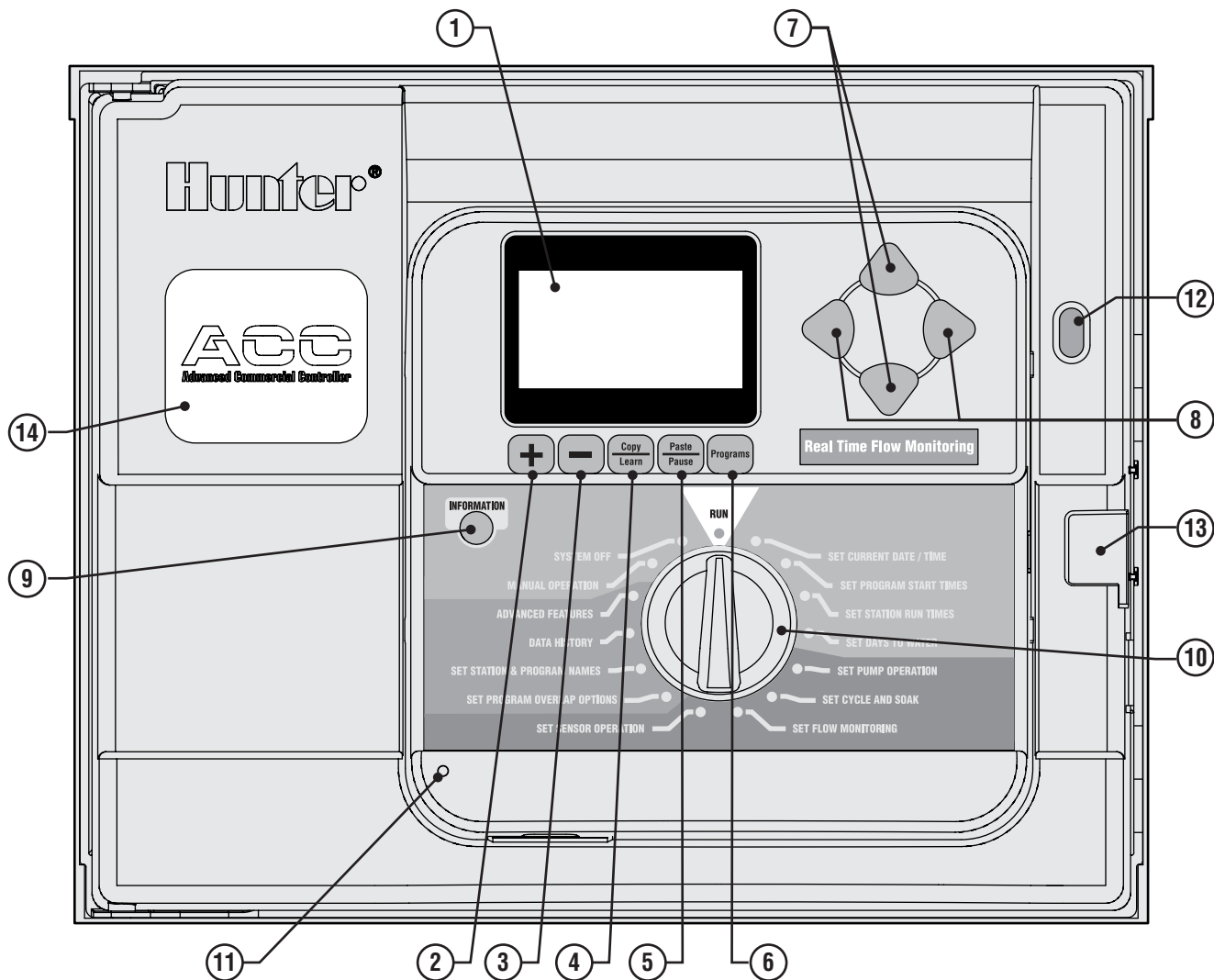

# WIRING COMPARTMENT INTERIOR

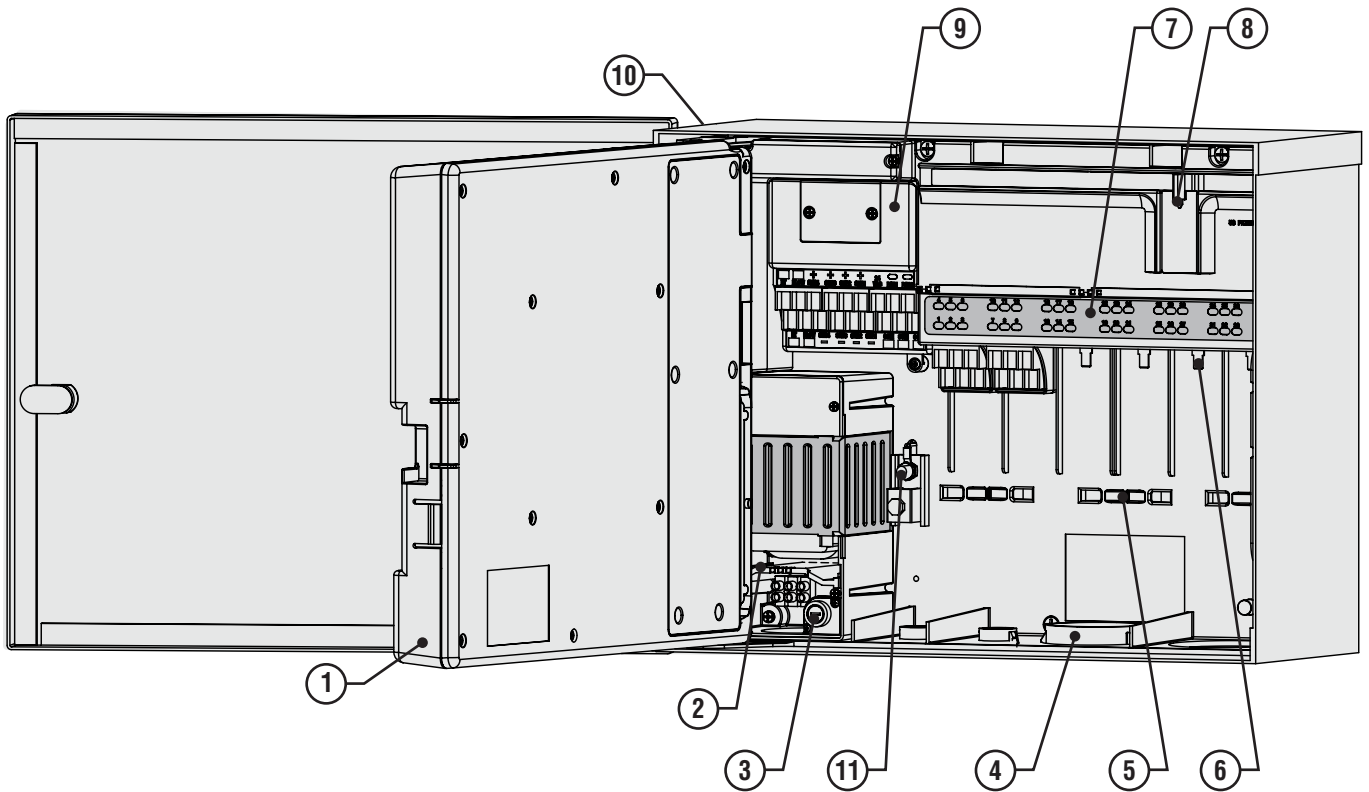

1. **Inner Door** – Opens to main wiring compartment
2. **AC Wiring compartment** – For connection of 120/230V AC power with 1 x 0.75" (19 mm) conduit opening
3. **Fuse** – 2 Amp (fast) 250V, 6 x 20 mm
4. **Conduit Openings, Low Voltage** – 2" x 2½" (64 mm), 2" x ¾" (19 mm)
5. **Wire Tie Holders for Valve Wires** – Valve wiring area
6. **Station Output Terminals (Valve Wires)** – screw terminals on 6-station output modules
7. **Upper Deck Panel with Led Status Indicators** – Numbered station lights, green for active, red for faults
8. **Sliding Lock for Output Modules** – Permits addition or removal of output modules, locks wired modules in place
9. **Master Module** – Includes sensor, Pump/Master Valve, and other accessory connections
10. **SmartPort®** – Integrated connector for ICR/SRR receiver (on side of cabinet)
11. **Earth Ground Lug** – For connection of earth ground copper wire (for surge protection only). Do not connect valve commons – see Master Module for Common wiring of solenoids and valves.

## Explanation of Symbols

 AC



Consult Documentation



Hazardous Voltage Present



Double Insulated

# METAL CABINET, WALL MOUNT INSTALLATION .....

Tools required:

- Long drill bit and extension
- Philips screwdriver or bit (for use with long extension) – magnetic recommended
- Wire strippers

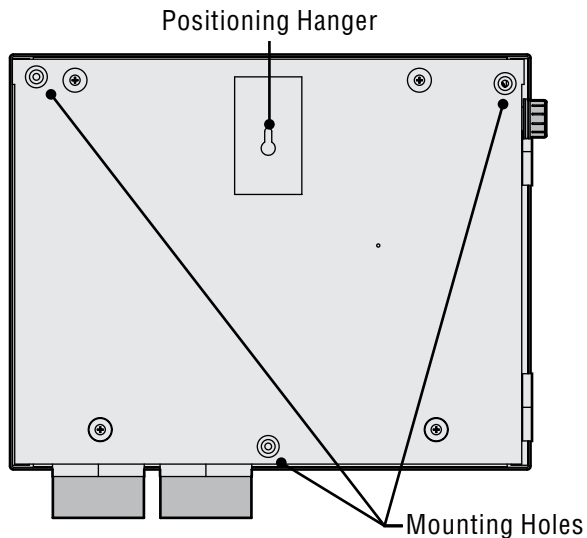
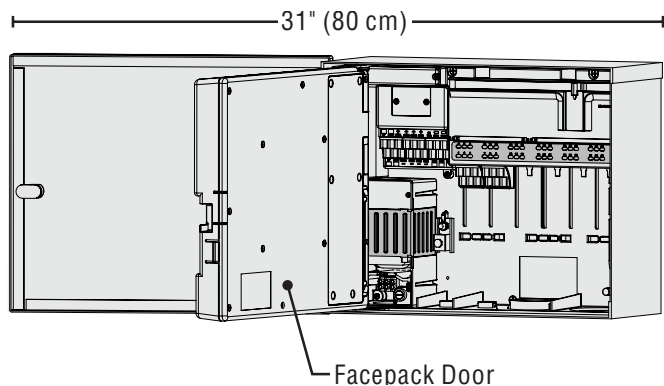

Location Requirement: A) a switch or circuit-breaker shall be included in building installations; B) the switch or breaker shall be in close proximity to the controller, and within easy reach of the operator; C) the switch or breaker shall be marked as the disconnecting device for the controller.

Avoid direct exposure to sprinkler spray.



Do not install controller within 20" (7 m) of high-voltage electrical sources, such as service transformers, pump station motors, etc.

Shaded or partially shaded areas are preferable to prolonged direct sunlight.

The ACC controller is relatively heavy, about 30 lbs/13.6 kg in the metal wall mount configuration. Mounting includes a positioning hanger to assist with installation.

Mounting hardware has been included, but it is the installer's responsibility to insure that adequate hardware is used for the physical location.

ACC is approximately 15½" (40 cm) wide. Allow another 15½" (40 cm) to the left of the controller for the door to open freely.

Before mounting, it is easier to remove the metal cabinet door. Swing the door open, grasp the top securely, and push up on the bottom of the door, near the lower hinge. The hinges should disengage and the metal door can be removed.

Remove the facepack assembly from the controller.

1. Open the facepack door using the recess on the right.
2. Disconnect the gray ribbon cable from the back of the facepack. Pull gently on the ribbon cable; a slight rocking motion may help disengage the connector.
3. Push up on the upper door hinge, and tilt the door so that it disengages the hinge posts. Remove the facepack and set aside in a safe location.
4. OPTIONAL: Locate the positioning hanger in the upper center of the controller's location on the wall, leaving adequate clearance for the opened door to the left.
5. Drill a pilot hole for the anchor and insert.
6. Install one #10 (5 mm) screw in this hanger position, leaving approximately ¼" (6 mm) out of the anchor to allow the controller to hang from this screw.
7. Hang the controller from the keyhole slot in the positioning hanger.
8. Place a level on the top of the controller cabinet and level.
9. Locate the 3 mounting holes in the cabinet. These are visible from the front, with the facepack removed, in deep recesses in the top two corners, and another shallow recess in the bottom center.
10. Mark each of these 3 locations and install anchors.
11. Reposition controller on the hanger and use a long screwdriver or drill extension (3"/75 mm) with magnetic tip to install the remaining 3 screws, one at each anchor position, and secure.

# CONNECTING AC MAIN POWER, WALL MOUNT CABINET.....

The ACC can operate with either 120 VAC or 230 VAC power, depending on how the incoming AC wires are connected.

Supply wires must be 14 AWG (2 mm) or larger.

**The ACC is prewired for 120V operation but can easily be changed to 230V.**

Consult or hire a licensed electrician for these connections as required.

- Turn AC power off at the source, and verify that it is off.
- Remove the wiring compartment screws and the wiring compartment door.
- Strip approximately ½" (13 mm) of insulation from the end of each of the AC power wires, and route into the wiring compartment through the conduit.
- Locate the white plastic terminal block, and wire according to the following diagrams.

For 120V~ operation, connect the incoming black power wire (hot) to align in the wiring block with the black wire lead from the transformer.

Insert the incoming black wire lead into the hole opposite the black transformer wire and tighten screw securely.

Connect the incoming neutral (white) wire to align with the blue lead from the transformer.

Cap off the brown (230 VAC) wire if applying 120V and not using a wiring block. The brown wire will be hot and have a 230V charge.

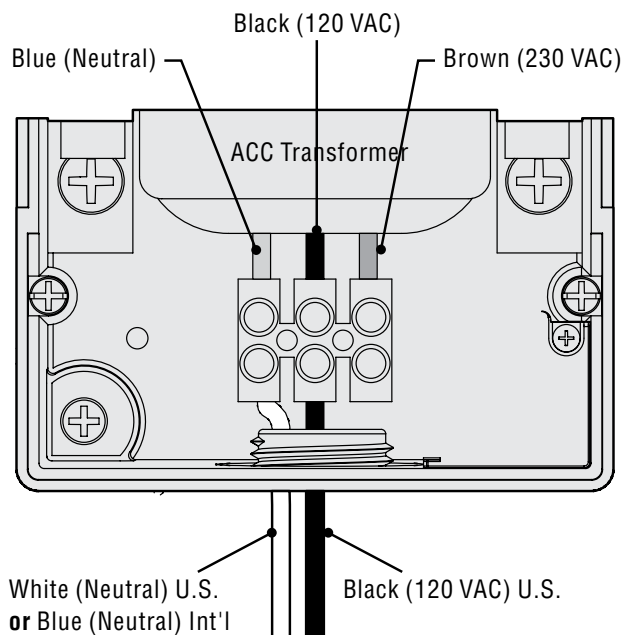

The green, or green-and-yellow safety ground may not be required or permitted with this floating ground, double-insulated transformer. If desired and permitted, connect it to the earth ground lug on the controller. Install a conduit junction T-box below the supplied junction box in the controller, and route the safety ground out of the T to the earth ground lug of the controller.

Tighten screw and replace cover.

For 230V~ operation, connect the incoming power wire (hot, brown in many wiring standards) to align in the wiring block with the brown wire lead from the transformer. Connect the incoming Neutral (blue in some international standards) wire to align with the blue lead from the transformer. Tighten screws and replace cover.

Apply AC~ power and test. Refer to Earth Ground and Station Wiring sections for additional connections.

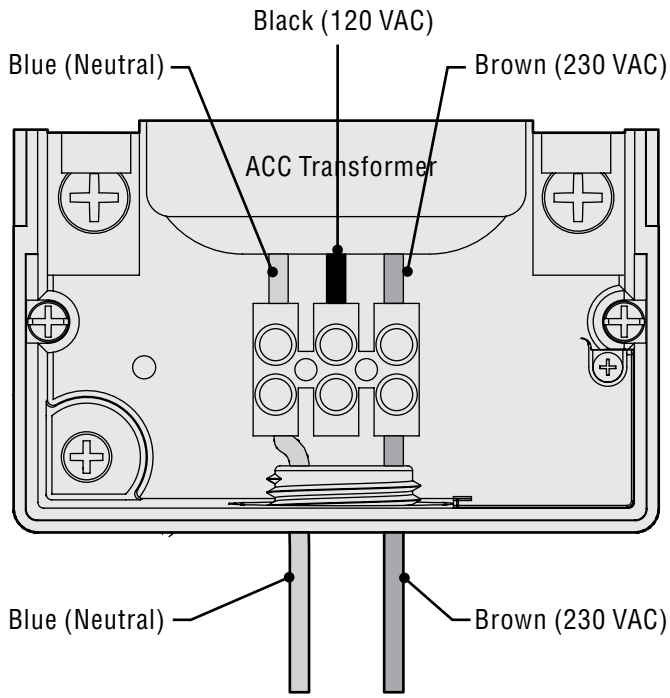

# METAL CABINET OPTIONAL PEDESTAL INSTALLATION .....

Location Requirement: A) a switch or circuit-breaker shall be included in building installations; B) the switch or breaker shall be in close proximity to the controller, and within easy reach of the operator; C) the switch or breaker shall be marked as the disconnecting device for the controller.

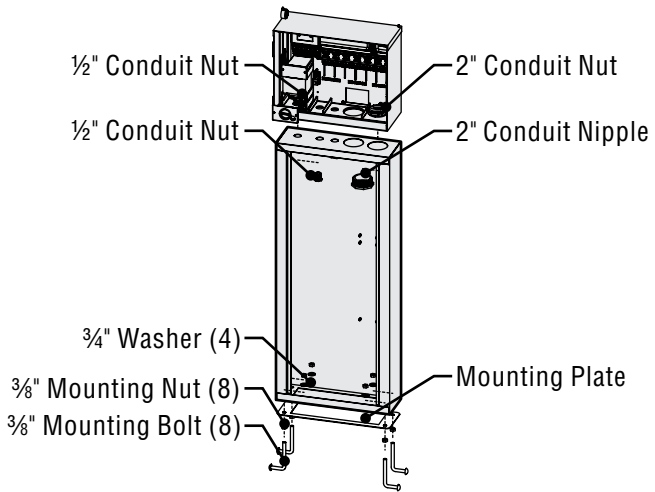

3. Level the mounting bolts before the concrete sets.
4. After the concrete sets, remove the door of the pedestal and slide the pedestal down onto the four bolts. Secure the pedestal to the bolts using the enclosed washers and nuts.
5. Remove the door and faceplate of the ACC and attach the metal cabinet of the ACC to the top of the pedestal using the 1/2" (13 mm) and 2" (50 mm) metal conduit nuts in the pedestal. Tighten securely by engaging teeth with a screwdriver and tapping in a clockwise direction.

## CONNECTING THE METAL PEDESTAL MAIN AC POWER

1. Connect AC power wiring as in the metal wall cabinet. Route the AC power wiring through the metal pedestal and up into the ACC wiring compartment. Follow the AC wiring instructions for the metal wall cabinet closely.
2. Replace the pedestal door first and then replace the faceplate and the cabinet door. The pedestal door cannot be removed or replaced when the cabinet door is closed.

## Installing the Pedestal

1. Assemble the mounting template using the instructions provided with the pedestal.
2. Using the enclosed mounting template, locate the bolts two inches deep in the concrete pad, in the locations indicated. The pad can be any size but at least a two-foot square is recommended.

Refer to Earth Ground and Station Wiring sections for additional connections.

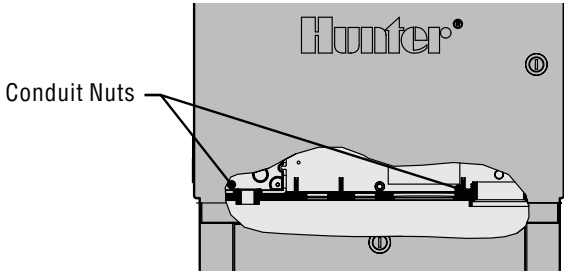

# PLASTIC PEDESTAL INSTALLATION .....

Select a location for installation of the controller based upon these factors:

1. Availability of 120/230 VAC~ power.
2. Do not locate under overhanging branches of trees or any structure that may attract lightning.
3. Avoid locations where sprinklers spray upward onto the controller, and low areas subject to flooding.
4. Locate controller in a location that is central to all valves/sprinklers that it controls to maintain visible operation and reduce wire lengths/costs.

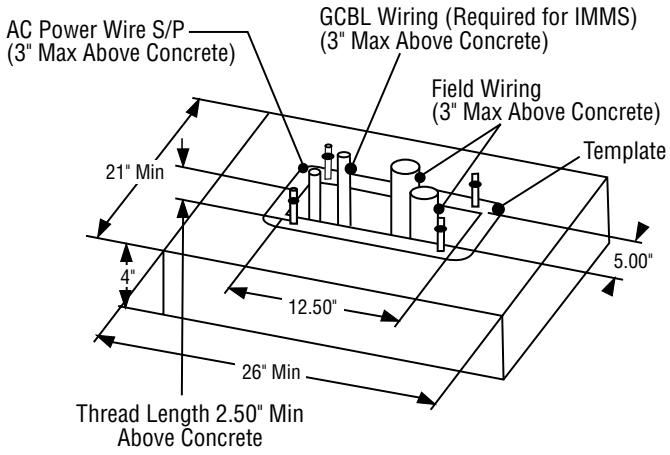

## CONCRETE BASE INSTALLATION .....

1. Set forms for a 21" (533 mm) wide x 26" (660 mm) long concrete base. The base pad should be 2" (50 mm) above grade for proper drainage.
2. Position a 1½" to 3" (38 to 76 mm) diameter conduit sweep elbow for the field wires (size will vary depending upon the number of valve wires entering the controller), a 1" (25 mm) conduit sweep elbow for the power supply, and a 1" (25 mm) conduit sweep elbow for any communication wires, if applicable. Secure the sweeps so they will enter the bottom of the controller correctly.
3. Allow approximately 3" (76 mm) of conduit above the surface of the concrete pad.
4. Shape the concrete base to shed any water away from the controller.
5. Prepare the template for insertion in the concrete. Twist one nut on each of the four J-bolts to the

bottom of the thread and slide each bolt through the hole in the template. Put a washer and nut on each J-bolt to secure it to the template (allow a minimum of 2½" (63 mm) of thread protruding above each nut).

6. Work the J-bolts down into the concrete until the template sits level on top of the concrete. Smooth and allow the concrete to cure (at least 24 hours).  
**NOTE:** It is important with plastic pedestals to ensure a smooth mounting surface. Uneven surfaces may cause the pedestal to distort, preventing proper sealing of the doors.
7. Remove the nuts and washers from the concrete base. Place the pedestal over the bolts and secure with nuts and washers.

**NOTE:** Remove both doors and lift the pedestal from the main body. Two people are required for this task.

## **CONNECTING PLASTIC PEDESTAL AC MAIN POWER.....**

The ACC Pedestal controller can operate with either 120 VAC or 230 VAC power.

Supply wires must be 14AWG (2 mm) or larger.

The controller power must be connected to a branch circuit protected by a 15 A rated over-current protective device (circuit breaker, fuse, etc).

With the main AC power OFF, route the AC power wires from the supply panel through the sweep elbow placed for this purpose in the concrete pad.

Do not route low voltage wiring with the AC power wires in the same conduit.

Locate the junction box below the transformer assembly on the left side of the controller. The AC power connections are made to the terminal block inside this junction box.

Route the AC power lines through conduit (if applicable) into the junction box.

All connections are to be made by qualified electrical personnel, only. Local electrical codes must be followed and may vary, depending upon country, state, and local codes.

### **120 VAC CONNECTION**

Place the Voltage Selector Switch in the “115V” position.

Connect the incoming black (or “hot”) wire to the Red wire from the controller transformer. The Red wire is labeled Hot, Phase, and Active. Connect either with the supplied terminal block, or with approved high voltage electrical wire nuts. If using wire nuts, tape the connection securely with electrical tape.

Connect the incoming white wire (neutral) to the blue wire from the controller transformer (labeled “Neutral”), either with the terminal block or approved wire nuts. If using wire nuts, tape securely.

The green or bare copper safety ground is not required with this UL listed floating ground, double-insulated transformer. If desired, you may connect it to the earth ground lug on the controller. Install a conduit junction T-box below the supplied junction box in the controller, and route the safety ground out of the T to the earth ground lug of the controller.

### **230 VAC CONNECTION**

Place the Voltage Selector Switch in the “230V” position.

Connect the incoming Brown power wire to the Red wire from the controller transformer, with the supplied terminal block. The Red wire is labeled Hot, Phase, and Active.

Connect the incoming Blue power wire to the Blue wire from the controller transformer at the terminal block. The Blue wire is labeled Neutral.

The green, or green-and-yellow safety ground may not be required or permitted with this floating ground, double-insulated transformer. If desired and permitted, connect it to the earth ground lug on the controller. Install a conduit junction T-box below the supplied junction box in the controller, and route the safety ground out of the T to the earth ground lug of the controller.

Place the connections up into the junction box through the opening in the bottom. Secure conduit if applicable.

Turn breaker power on, then turn the controller power switch on and test.

The controller is equipped with a 6 x 20 mm, 250V, 2 Amp fast-blow fuse on the transformer assembly. Incorrect power wiring may cause this fuse to open. Check wiring and incoming power if the fuse opens when power is turned on.

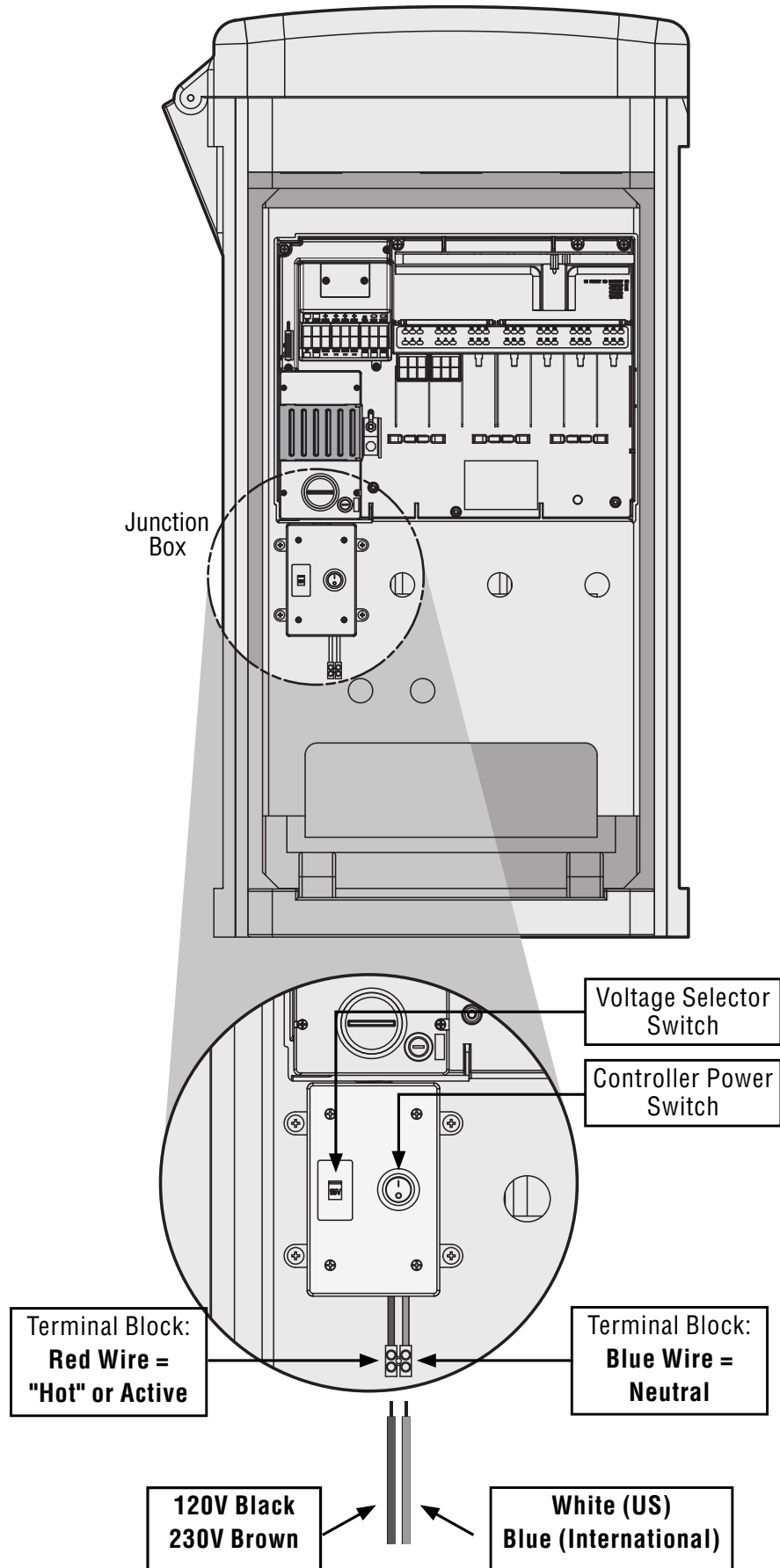



## CONNECTING EARTH GROUND (ALL CONFIGURATIONS).....

The ACC features a copper earth ground lug, to the immediate right of the transformer assembly.

This earth ground connection is isolated from the primary AC power and is used to ground incoming surges from the communications and output valve wires.

With the controller power Off, loosen the slotted screw in the center of the ground lug.

Route a bare 6 AWG (4.11 mm) earth ground wire into the wiring area through the 0.75" (19 mm) conduit opening directly beneath the ground lug, in the bottom of the controller cabinet. Do not route the ground wire through the same conduit as the incoming primary AC power!

Loosen the ground lug screw, insert the ground wire into the ground lug and tighten the screw to secure the ground wire. Do not overtighten.

Grounding hardware should be selected according to standards established by American Society of Irrigation Consultants Earth Grounding guideline 100-2002 (available at their website, [www.asic.org](http://www.asic.org)).

Acceptable grounding consists of an 8' (2.5 m) copper-clad rod or stake, or a 4" x 96" (100 mm x 240 cm) copper plate, or both, placed in the earth at least 8' (2.5 m) away from the controller, and with the ground wire at right angles to the communications and valve wires, if possible. Ideal grounding resistance would be 10 Ohms or less as measured with a "megger" or similar device. Please consult the ASIC reference for more detailed considerations of this critical step.

Improper connection to earth ground voids the effectiveness of the output module surge protection.

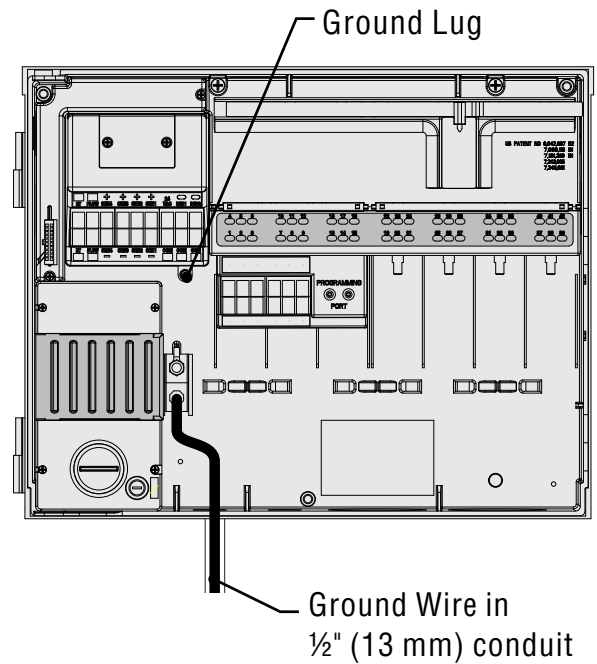

# INSTALLING STATION MODULES.....

ACC expands in 6-station increments with intelligent output modules, requiring no tools to install and only a screwdriver for station wiring connections. The base configuration is 12 stations (two 6-station modules installed) with a maximum station capacity in a metal wall cabinet of 42 stations (7 total output modules x 6 stations each).

ACC can be expanded at any time with either of the following types of modules:

1. ACM600, 6-station output module with surge suppression and diagnostic LEDs
2. AGM600, 6-station output module with heavy-duty surge suppression and diagnostic LEDs

These two types of modules may be mixed within the same installation if desired.

## OUTPUT MODULES (ACM600, AGM600)

- A. Station Output Screw Terminals – Connect no more than two solenoids each.
- B. Station Status LEDs – Green for station activity, Red for fault or short
- C. Locking lugs – For module lock
- D. Gold plated electrical contacts – Lower rear of module
- E. Additional surge components, AGM versions – Visible through module

1. To install expansion modules, turn the dial to the “Run” position.
2. Open the inner facepack door, and locate the module lock. Slide the module lock to the “Power Off” position.
3. Flip up the upper deck cover. Slide the modules up, into the next available position. Slide the modules up, into the next available position, viewed from left to right. Do not skip slots by leaving them empty.
4. Install a module by aligning it firmly in the lower portion of the next available slot and sliding straight up until it clicks into place. Once module is in place, slide power bar to the "Power On" position. The first two lights of the bottom and top row of each module installed will light up red for 1 second, indicating proper contact and the new module has been recognized. The red lights will then turn off, in sequence, from left to right across the modules that are installed.
5. The silver contact on the back of the controller cabinet must engage a mating slot in the back of the expansion module. Do not “tip” or force the module into place. Slide straight up, from the bottom of the slot.
6. While at the Run dial position, press the Information button. The current station size will be shown, and should include any new modules you have added.

### Station Modules

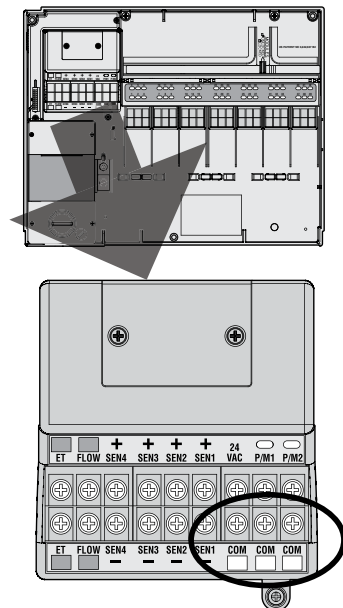
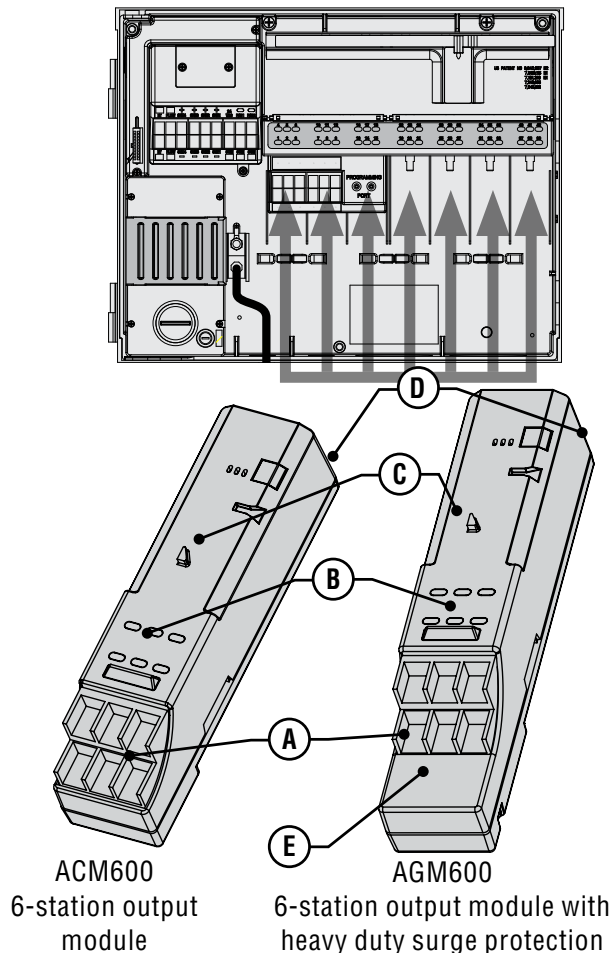

## CONNECTING THE VALVE WIRES

Each station output module has 6 screw terminals for connection of individual station wires. The terminals will accept from 22 AWG (0.64 mm) to 12 AWG (2.05 mm) wires.

Each station output is rated for 0.56 A, max or enough to operate two typical Hunter solenoids simultaneously.

Once the output module is installed in the slot, the station numbers assigned to the output module appear in the upper deck label above each slot.

1. The modules may be removed, if necessary, without disconnecting the field wiring. However, they must be reinserted into exactly the same slot, or the station addresses will be switched.
2. Connect the return wires from the valves to one of the 3 terminals on the Master Module marked COM. Since many valve solenoid wires will need to connect to these 3 common terminals,
3. Route valve wires between control valve location and controller.
4. At valves, attach a common wire to either solenoid wire of all valves. This is most commonly a white colored wire. Attach a separate control wire to the remaining wire of each valve. All wire splice connections should be done using waterproof connectors.
5. Open hinged faceplate on the controller to access the terminal area.
6. Route valve wires through the conduit and attach conduit to the controller at the large conduit openings on the right side of the bottom of the cabinet.
7. Strip ½" (13 mm) of insulation from ends of all wires. Secure valve common wire to COM (Common) terminals on the Master Module. Then attach all individual valve control wires to appropriate station terminals.

## DECODER OUTPUT MODULE (ADM99)

- A. Two Wire Path Terminals – Connect no more than one pair of red and blue wire paths to each output terminals
- B. Status LEDs– Decoder Fault, Module/Line Activity, Communicating, Line Status
- C. Locking Lugs
- D. Gold-plated Electrical Contacts
- E. Programming Port – Port where decoder wires get plugged into in order to program the decoder

## Decoder Output Module

Upper Deck cover

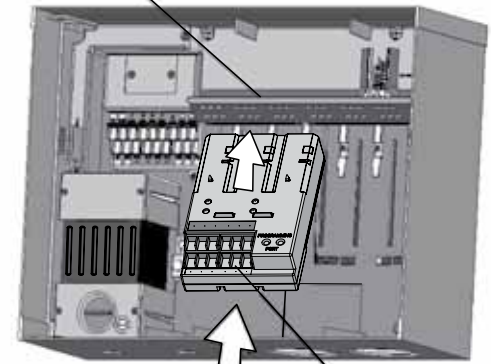

Slide ADM99 in first 3 slots

ADM99 Decoder Output Module

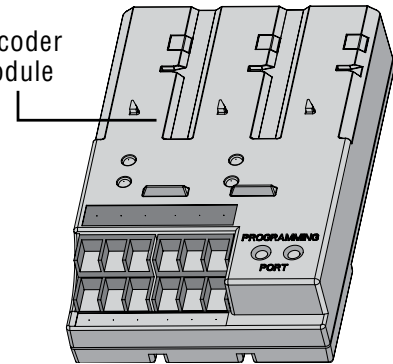

1. Decoder output modules may NOT be mixed with the "conventional" ACM/AGM-600 output modules.
2. Decoder output modules are always installed in the first three slots.
3. Install the ADM99 by aligning it firmly into the first three station module slots, and sliding straight up until clicks into place. As soon as the ADM99 is slide into place, the Module/Line Activity light will light red for one second, and then the Line Activity light will illuminate green. Unlike the station modules, the ADM99 will illuminate the status lights with the power bar in the "Power Off" position.

## CONNECTING DECODER OUTPUT PATH WIRES

Up to 99 stations may be operated over a single pair of wires (known as a "path") using decoders. The decoder output module allows up to 6 two-wire paths to the field decoders. The maximum number of decoder stations is still 99, but multiple paths allow the shortest wire runs. You may use any number of paths to reach all 99 stations.

Each path should consist of Hunter Industries Model IDWIRE1 or IDWIRE2 color-coded decoder wire. This is a twisted, solid-core wire suitable for direct burial, and is always color-coded red and blue.

All red/blue connections in the two-wire path must be made with DBR6 waterproof connectors or equal.

Each path has a red and a blue terminal with its number on the decoder output module.

1. Route decoder path wires through the conduit into the wiring compartment. Leave adequate slack in the wires for thermal contraction.
2. Strip ½" (13 mm) of insulation from the red and blue ends.
3. Connect the red wire to the red "1" terminal, and the blue wire from the same pair to the blue "1". Repeat for any other paths as needed.

Do not connect the paths in a loop, or back to any other point in the controller. Leave the red and blue paths

separate at the end of each two-wire run. Simply insert decoders in the path until complete, and stop at the last decoder on the path. If this is not possible, simply cap each of the ends of the two wire path with a DBR6 waterproof connectors or equal.

Do not connect a wire path from one controller to another controller!

When a decoder output module is installed, the controller facepack will recognize it and the station size will change to "99" (regardless of how many stations are in use). This will also unlock the normally Extended Decoder displays in the following dial positions. See *DECODER OPERATIONS (ACC99D VERSIONS)* on page 56 for more information.

## KEY CONNECTIONS.....

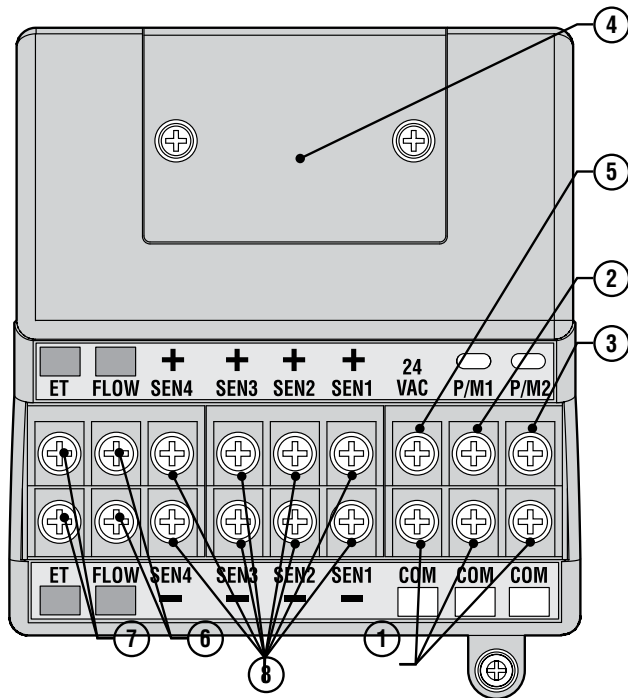

1. Common Ground Terminals (x 3) – For return wires (often white) from stations and master valves. Field wiring may be returned to any of these 3 terminals
2. P/M1 – Pump/Master Valve output 1, and status light (return Pump/Master valve circuit to any of the 3 Com common terminals). Output is 0.320 Amps max
3. P/M2 – Pump/Master Valve output 2, and status light (return Pump/Master valve circuit to any of the 3 Com common terminals). Output is 0.320 Amps max
4. Hardwire terminal connection cover – Remove to install optional ACC-HWIM for hardwired communications.
5. 24VAC – Always-on 24V test terminal, for locating valves in the field. Can also be used to power low-draw sensor receivers such as Hunter WRC. Output is 0.420 amps maximum
6. Flow Sensor connections (+ and -) – Connections for Hunter HFS flow sensor
7. ET connections (+ and -) – Not used. Connections for Hunter ET Sensor only. If upper ET terminal is colored red, Master Module requires update for use with ET.
8. If Master Module has a sticker that says "ET Ready," or if the version number of the module is 4.0 or later, the Master Module is ET ready
9. Sensor Connections (1-4) – Connections for up to 4 Clik-family sensors, or other normally closed switch contacts

## 24 VAC TEST TERMINAL .....

The Master Module features a “constant-hot” 24 VAC output which can be used as a test point for locating valves in the field:

1. After powering up the controller, attach the common wire to the COM terminals as described above.
2. Touch each wire to the terminal marked 24 VAC to identify the valve location.
3. Each valve will open electrically when the wire is touched to the 24 VAC terminal.

4. After identifying the valve location, you may then insert the wire into the appropriate terminal. This feature allows you to sequence the valves in the most logical order for the user without damaging the controller by “sparking” the wires.
5. The 24 VAC terminal may also be used to power wireless Clik sensor receivers. *See Connecting a Rain Or Freeze Shut Off Device on page 14 for more information..*

## CONNECTING THE MASTER VALVE(S) AND/OR PUMP START RELAY(S)

The Pump/Master valve connections are located in the upper right of the Master Module, which is in the upper left corner of the controller itself.

Locate the P/M1 and P/M2 screw terminals on the Master Module. These outputs are designed to supply 24 VAC, 0.320 A max, for a single Master Valve solenoid or a Pump Start Relay (or Relay Booster).

The return wire from each P/M device (solenoid or relay) must be connected to one of the COM terminals on the lower terminal strip of the Master Module.

Connect one output wire from each Pump relay or Master Valve solenoid to the desired 24 VAC P/M terminal.

Connect the return wire to one of the terminals marked COM immediately below the P/M outputs.

Configuration of the P/M terminals is covered in the Set Pump Operation section of the Programming and Operations portion of this manual.

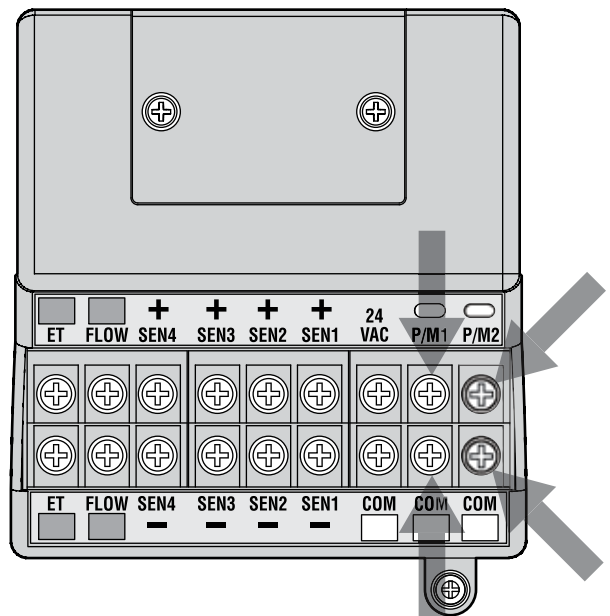

## CONNECTING A RAIN OR FREEZE SHUT OFF DEVICE .....

Up to 4 Hunter sensors can be connected to the ACC controller, including:

- Mini-Clik®
- Rain-Clik™ (including Wireless Rain Clik)
- Freeze-Clik®
- Mini-weather station

Hunter Flow-Clik™ can also be connected, but it is recommended that the HFS be used instead.

In the ACC controller, Clik sensors shut down individual programs, not necessarily the entire controller. Each sensor can be given its own response instructions by program.

Hunter Clik sensors are usually normally closed, and open on alarm. This signals the controller to suspend irrigation. Other dry contact closure sensors can be used without warranty, provided that a.) they require no voltage; and b.) open the circuit when a shutdown condition is sensed. Hunter makes no claims or representations that such connections will be effective.

1. To connect Clik sensors, locate the SEN [1-4] terminals on the Master Module (upper right corner of controller).
2. Route the pair of wires from each sensor into the cabinet through one of the low voltage conduit openings in the bottom of the enclosure.

3. The sensor connections are made in dedicated pairs: one wire to the sensor number + terminal, the other wire from the sensor to its – terminal. Do not twist common wires together from different sensors and connect them to the same terminal.
4. Loosen the screw for the first sensor terminal (SEN1), and connect either of its wires to the + terminal and tighten.
5. Connect the other wire from that sensor to the SEN1 – terminal and tighten.
6. To connect the wireless Rain Klik (WRC) or wireless Rain-Freeze Klik receiver, consult the instructions supplied with the WRC for mounting and addressing.
7. Connect either of the receiver’s Yellow power wires to the “24 VAC” terminal on the Master Module (the “24 VAC” terminal has a 400 mA maximum capacity and is adequate for Klik receivers).
8. Connect the other Yellow receiver wire to any of the COM terminals.
9. Complete the wireless Klik installation according to the WRC instructions.

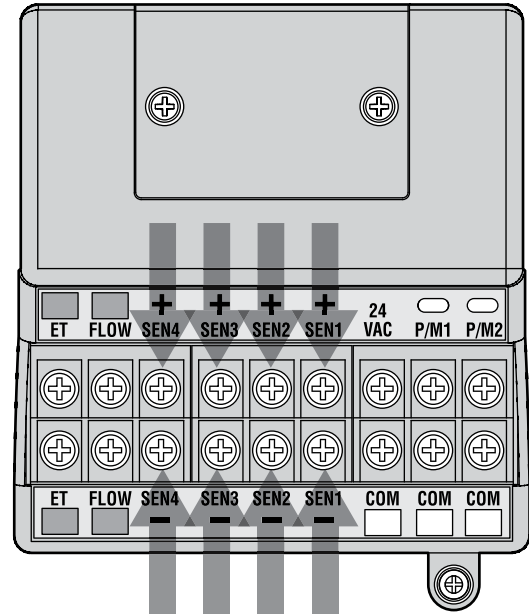

All additional programming is performed at the facepack and is described in the Set Sensor Operation section of Programming and Operations.

## CONNECTING THE HUNTER FLOW SENSOR.....

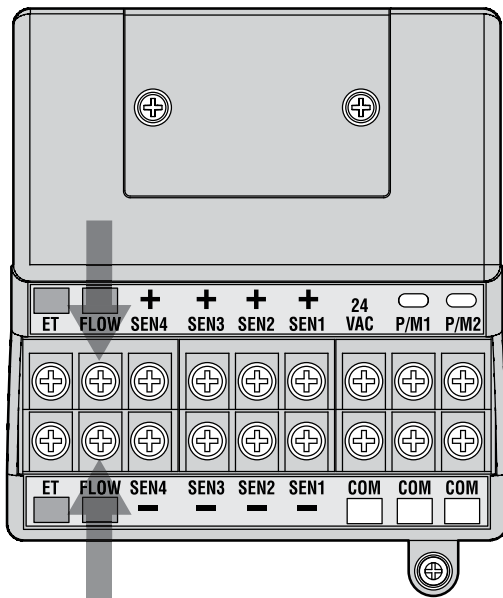

The HFS is the primary flow meter for which ACC flow functions have been designed. Additional types of flow sensor connections may also be possible. Consult flow sensor manual for wiring and calibration information.

1. To connect a HFS, route the pair of 18 AWG (1 mm) wires from the sensor into the cabinet through one of the low voltage conduit openings in the bottom of the enclosure.
2. Locate the “Flow” red and black coded terminals near the left side of the Master Module. Connect the red wire from the HFS to the red terminal, and the black wire from the HFS to the black terminal.
3. Reversing the red and black connections will probably not damage the units, but will not allow the ACC to read flow.
4. Flow setup, learning, and configuration is described in the Set Flow Monitoring section of Programming and Operations.

## CONNECTING OTHER FLOW SENSORS.....

Some other brands or models of flow sensors may be compatible with the ACC controller. One known-compatible model is Data Industrial model IR-220B (also sold as Hunter model GENDATFL).

NOTE: The ACC flow sensor connection is a 20 VDC pulsed output which senses interruptions as “clicks”. It is DC voltage, and the polarity must be observed.

The red + terminal corresponds to the red wire on the HFS sensor, and if connecting to other brands of sensor insure that correct polarity is observed.

Connect the positive (+) wire to the red Flow terminal on the Master Module, and the negative (-) wire to the black terminal.

## ICR REMOTE CONTROL.....

The ACC controller has an integrated SmartPort®, on the cabinet’s upper left side, or inside the front panel of the plastic pedestal. This connection is automatically compatible with Hunter ICR and SRR remote receivers.

To connect: remove the weather-resistant rubber cover (metal cabinet versions), align the remote receiver’s pins with the mating receptacle, and push firmly until the receiver is fully seated. If the ET System adapter is installed, plug the receiver into the mating connector on the adapter.

If the receiver address is to be changed, hold in the green button while plugging the receiver into the SmartPort, in accordance with the ICR instructions.

Refer to the remote control’s instructions for additional addressing and operations. However, there are some significant differences in operating the remotes with the ACC controller, from previous Hunter controllers.

When a program or station is started by ICR, the ACC display will (as always) show why the program or station is running. Remote starts are followed by “ICR” in the display (Fig.1).

To set up an ICR remote control for operations with ACC, consult the ICR instructions. Use the Mode button on the ICR transmitter to select a station size of “240” to allow access to all ACC programs and stations. Only ICR Remotes manufactured September 2006 or later are compatible with ACC. If you have an older ICR remote, the maximum station size is 48. Therefore, if you are using an older remote and an ACC decoder controller, the highest station you will be able to control is station 48. You must obtain a newer ICR to operate correctly with any ACC controller.

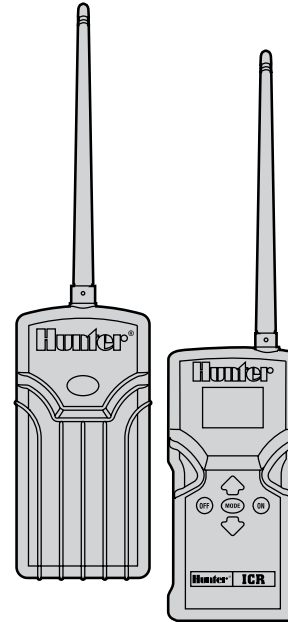

Figure 1

## MULTIPLE STATIONS SIMULTANEOUSLY

ACC is an overlapping controller, and will allow up to 6 stations to run simultaneously. While other Hunter controllers will stop existing stations when a new ICR remote start command is received, the ACC will continue to run existing stations along with the new stations, until the maximum of 6 events has been reached (Fig. 2). If 6 events are running and an ICR command is received to start another, the command will be ignored. No new remote commands will be accepted until one of the 6 events times out.



Figure 2

ACC can therefore run automatic programs, manual station and programs, and ICR commands simultaneously. Each running event will be shown on the display with the reason for running (programs will be shown with the program letter followed by "ICR" if they were started by the remote), and the remaining time for the event.

The display shown here is possible with ACC: six events are running, including ICR station starts (ICR), ICR program starts (A-ICR), manual single-stations (MAN), manual program starts (C-MAN), and an automatic program (D-AUTO).



Figure 3

If simultaneous operation is not desired, press the Off button on ICR before starting another program or station. Off will stop everything the controller is running, regardless of what started it.

Stacking and SmartStack rules are not observed when manual single station ICR commands are sent to the ACC. Stacking and SmartStack rules do apply when manual program ICR commands are sent to the ACC. If a program

is not set to overlap, the ICR command will be ignored when trying to start the manual program.

ICR manual single station commands will be obeyed if the controller is in the OFF position, or in a sensor shutdown mode. ICR manual program commands will NOT be obeyed and will be ignored in the OFF position. If the controller is in a sensor shutdown mode and an ICR command is sent to activate a program, the ACC will obey the sensor shutdown if that program is assigned to pause or suspend according to the sensor. The manual program ICR command will be shown in the display as in pause or suspend mode, depending on how you have your sensor programmed. (Fig 3) If the program that you are trying to manually start with an ICR command is not programmed to pause or suspend a sensor, the command will be obeyed and the program will run.

If you are utilizing a simultaneous station group, or SSG, you may run an individual station that is included in the SSG. The fact that the station is included in the SSG will be ignored, and you may run that station by itself.

## CONNECTING TO IMMS ..... HUNTER IRRIGATION MANAGEMENT AND MONITORING SYSTEM

ACC controllers can be upgraded to provide full two-way communications with central control software (IMMS 2.0).

The ACC Com modules are installed in place of the logo badge on wall mount controllers, and under the facepack door in a special bracket (APPBRKT) in pedestal units.

ACC controllers can be connected with hardwired cable (GCBL), dial-up telephone (POTS or "plain old telephone service"), or GSM cellular communications (using Circuit Switched Data or CSD).

Multiple controllers can share a connection, with additional runs of hardwired cable or UHF radio communications. Advance to Daylight Saving and use +/- to select YES.

No tee splices are permitted within the GCBL and all hardwired devices must be in one single continuous wire run.

### DIAL-UP TELEPHONE (ACC-COM-POTS)

Connection must be within 6 ft (2 m) of the telephone company connection, via standard RJ-11 jack..

IMMS 2.0 and dial-up Com modules require analog lines with dial tone. These products do not have digital dialing capabilities.

Dial-up must be via dedicated line. The controller will always answer on the first ring and must not share with fax machines or other devices.



## CELLULAR/GSM (ACC-COM-GSM, GSM-E)

GSM cellular service must have reliable coverage at installed site.

GSM service must permit and provide Circuit Switched Data (CSD). IMMS 2.0 connections require CSD and will use the Data telephone number. No other form of cellular communications will work. There are no CDMA options for ACC communications at this time.

## UHF RADIO

All UHF radio communications require a license.

All radio communications for ACC work with RAD3 radio module or later. IMMSR radios, designed for original IMMS Site Interfaces and Controller Interfaces, will NOT work with ACC controllers.

RAD3 radios are not supplied with antennas, but an antenna must be provided for the radio to operate, and the antenna must be installed outside of any metal enclosure (including the ACC metal cabinet).

Radio communications for the ACC are only to communicate with other ACCs, and do not provide communications directly with a central computer. This should be established with an IMMS-CCC and a hardwire interface, or by telephone using ACC-COM-POTS or ACC-COM-GSM (or GSM-E for international applications).

For golf applications using Surveyopr central control software only, the AGCHUBR provides a direct radio interface to all radio-equipped ACC/AGC controllers.

*See Hunter's ACC System Design Guide for important details regarding design of central control systems.*

## POWER FAILURES .....

The ACC's real time clock is independent of external power or the 9 VDC battery, and will keep time during a power failure of virtually any length. When external power is restored, the ACC will still have the correct time and will be ready to irrigate.

A Power Outage message will be stored in the Alarm Log, with time of the outage. Another log is stored when power is restored.



## QUICK START .....

For experienced operators, the fastest steps to initial programming are as follows.

- 1. Set Current Date/Time:** Use the arrow buttons to navigate, and the +/- buttons to change. Set the Date and Time and choose Units of Measure.
- 2. Set Watering Start Time:** Each automatic Program has 10 start times. At this position, use the Programs button to select individual programs, and the 10 possible start times for that program will appear. Use arrows to navigate and +/- to change. See *SETTING PROGRAM OVERLAP OPTIONS* on page 36 for more information..
- 3. Set Station Run Times:** At this dial position, use the Programs button to select the program you are

setting up. Then, use the +/- buttons to change the hours:minutes:seconds run time for each station. Use the up and down arrows to move to the next station. TIP: Use the Copy and Paste buttons to move quickly through large numbers of similar stations. Set the first station's run time, then press Copy. Use the Up arrow to move to the next station, and press Paste.

- 4. Set Days to Water:** Use the Programs button to select the Program. Use the arrows to move to Day Sched, and choose Schedule Type (Day of Week, Interval, or Odd/Even).
- 5. Set Pump Operation (optional):** The two Pump/Master Valve outputs may be set by station at this position. If no pump or Master Valve is in use, this is not required.

6. **Return the dial to the Run position.** This is all that is required for the most basic operations. ACC will water automatically in any dial position except “OFF”.
7. **Test:** The Test program will start every station in the controller sequentially, in numerical order, for the specified time. **The minimum time is one second for conventional controllers, and 15 seconds for decoder controllers. The maximum run time in Test Program is 15 minutes per station.** Turn the dial to the Run position. Test is started by holding down the Programs button for 3 seconds. Enter the Test time and wait 5 seconds for the Test cycle to begin. Each station LED on the output modules will light green when a station is running, red if a fault is detected. Decoder controllers cannot show individual station activity, but the ADM99 lights will show activity on the Communicating and Module/Line Activity lights during operations. Decoder controllers will start all 99 stations in the test mode. It does not matter how many decoders are installed in the field, the controller will try to run all 99 stations. The controller will receive alarms for any stations that are not present in the field, or stations that are not assigned to a decoder. When running the Test Program in a decoder controller, you can manually end the Test by turning the dial to

Off after the last “real” station has run.

**Test actually starts stations, and this will cause actual watering in a fully installed system.**

8. **Manual Start:** Turn the dial to the Manual Operation dial position to manually start any Program, or single station. When the display shows Manual Program, use the Programs button to select the Program, and turn the dial to the Run position. The program will start in a few seconds. TIP: You can also hold down the right arrow button for 3 seconds to shortcut to Manual starts.
9. **To start a Single Station:** When “Program” is flashing, use the + button to change to Manual “One Station”. Use the down arrow to move to the station number, and +/- to select a station. Use the down arrow to move to the run time, and +/- to change the run time (hh:mm:ss format, from 1 second to 6 hours). Turn the dial back to the Run position, and the station will start within a few seconds.

## CONTROLLER PROGRAMMING AND OPERATION.....

### USING THE INFORMATION BUTTON

The Information button is used to provide programming tips, summary information and/or to unlock extended features, depending on the dial position. If a flow meter is installed, press the Information button (with dial in the Run position) to see actual flow at any time.

If the backlit display turns off while you are programming (it will time out after 5 minutes of inactivity), press the Information button to relight it (to prevent accidental changing of any settings by pressing the other keys).

Pressing and holding the Information button will change the screen to either a summary screen of that dial position or will provide a programming tip. Releasing the button will return you to the normal programming screen for that dial position.

Some dial positions have extended features that are accessible by holding down the Information button, and then turning the dial to that position.

This will unlock the extended features. Extended features are features that are protected from accidental re-programming because they are critical to the proper operation of the controller. Programming these extended

features is explained in the Extended Features section. The ACC has the following Extended Features:

- No Water Window
- Delay between Stations
- Making the M/V circuit Normally On (instead of Normally Off) and M/V circuit location (Controller or ADM for Decoder controllers)
- Setting the Flow Sensor size and type
- Set individual station parameters (Flow, Limit, and Delay) and flow sensor location (Controller or ADM for ICD-SEN sensor decoder)
- Set sensor location: set each sensor to controller, ADM for for ICD-SEN location, or ET for individual ET sensors
- SSG (Simultaneous Station Group) setup
- Custom Manual program setup
- Test Program
- Easy Retrieve™ backup

## SETTING CURRENT DATE AND TIME

Three items are programmed at this position:

- Time of Day and Date, the day of the week sets automatically
- Daylight Savings time usage
- Units of measure, English or Metric

Turn the dial to the SET CURRENT DATE/ TIME position

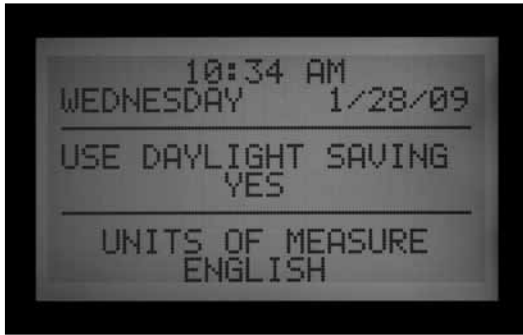

Press the + or – button to change the value of the flashing cursor. Hold the button down to advance rapidly over a large range of numbers.

Press the arrow buttons to change cursor position. Set the hour and the minutes, then advance to the AM/PM field. Use + or – to select AM, PM, or 24 hour clock (international, or “military” time). If 24 hour clock is selected, Program Start Times and other controller times will also be displayed in 24 hour format.

Press the arrow buttons to advance and set the date in MM/DD/YY format.

ACC Daylight Saving Time has been updated for the new USA requirements. If set to Yes, time will offset one hour forward at 2 AM on the second Sunday in March, and reset (“fall back”) on the first Sunday in November.

Units of Measure: choose English or Metric. This will set the unit type for the entire controller.

## SETTING PROGRAM START TIMES

Three items are programmed at this position:

- Overlap or Stack start time priority
- Start times for each of the six programs (A – F)
- Extended Feature: No Water Window

## To Set Program Start Times



1. Turn the dial to the SET PROGRAM START TIMES position
2. Select the Program (A – F) by pressing the Program button
3. Press the arrow buttons to change cursor position
4. Press the + or – button to change the value of the flashing cursor
5. Select Stack or Overlap for the Program. It is important to know that if the setting within the Set Program Overlap Options dial position is not set to “Stack or Overlap,” the option of selecting Stack or Overlap (at the Start Times position) will not be possible.
6. The copy and paste buttons may be used to speed up programming (press the Copy button at any Start Time position, then move to another position and press the Paste button. The same Start Time will be pasted there).

### Stacked Start Times

Stacking means that programs are not allowed to overlap; if one Program is set to start before another Program has completed, it will be pushed back (“stacked”) regardless of its actual start time.

Each of the six programs (A – F) has ten start times available, for a total of sixty available automatic starts. The default is to stack the start times in alphanumeric order. Program A will read Overlap, but all other programs will read Stack. For instance, start time “Program A at 8:15 AM” would start before “Program B at 8:15 AM” because A comes before B. The Start Time for Program B at 8:15 AM would start following the completion of Program A’s watering.

### Overlapping Start Times

Overlapping start times allows more irrigation to occur simultaneously. Overlap starts Programs at their exact Start Times, regardless of other Programs that may be running (it is the opposite of Stacking). All six programs can be programmed to Overlap and thus potentially run simultaneously. This is great when a short watering window is necessary and the hydraulics of the system allows for high total water flow.

**CAUTION:** Understand your irrigation system's hydraulic restrictions before allowing programs to overlap. Overlapping programs may overdrive the hydraulics of your system. Overdriving your hydraulics will damage the components and result in inferior sprinkler performance.

More advanced programming overlap options are available by turning the dial to the SET PROGRAM OVERLAP OPTIONS dial position.

Normally, the cursor will be positioned at the first Start Time hour position when turning the dial to the Set Program Start Time position.

- To change the Stack/Overlap settings for the Program, use the arrow key to navigate up to the Stack/Overlap indication.
- Use + or – to change between Stack and Overlap.
- Use the arrow keys to move back down to the Start Times if necessary.



### Multiple Start Times

To set Start Times for the Program, move to the Start Time number, and use the + or – buttons to set the hour, then minutes, and then AM/PM settings unless using 24-hour option.

- If a Start Time is skipped (for example, a time is set for 1, 2 is left at OFF, and a time is set for 3), the Start Time will be accepted, but when returning to this dial position, the Start Times will be moved to a sequential order (the Start Time set for 3 will have been moved to 2). This is by design.
- If an earlier Start Time is set for a higher-numbered Start (for example, Start 1 is set to 4:00 AM, and Start 2 is set to 3:00 AM), when returning to this dial position the Start Times will have been reorganized in chronological order. The lowest numbered Start Time will always have the earliest time of day (in the example, Start 1 will be at 3:00 AM and Start 2 will be at 4:00 AM).

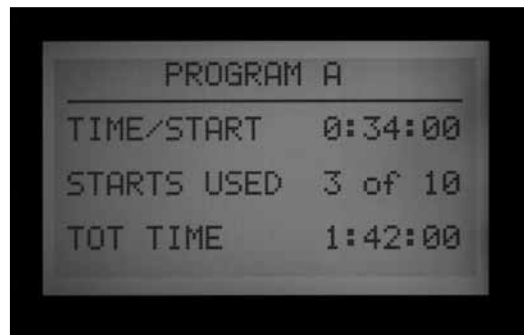

Press the Information button while in the Set Watering Start Times position to show a summary of all Start Time information for the selected Program. This will show total station run time per start, number of starts, and total time for the program.

### No-Water Window

Programming this feature is explained in the Extended Features section.



### SETTING STATION RUN TIME DURATION

Three items are programmed at this position:

- Station watering duration
  - Seasonal Adjust value for the Program
  - Hidden Feature: Timed Delay between Stations
1. Turn the dial to the SET STATION RUN TIMES position.
  2. Select the Program (A – F) by pressing the Program button
  3. Press the + or – button to change the value of the flashing cursor. The cursor initially appears in the minutes field.
  4. Press the right and left arrow buttons to change from minutes to hours or seconds cursor positions. Set the run time in h:mm:ss format.
  5. Run times may be from 1 second to 6 hours, or any increment in between.
  6. Press the up and down arrow buttons to change to a different station number
  7. The copy and paste buttons may be used to speed up programming.

**NOTE:** If the ACTUAL value is different from the PROGRAMMED value, Seasonal adjust has been changed from the default of 100% to a new value. The actual run time is the duration the station will water.



Press the Information button with any station selected at the Set Station Run Times dial position to see a summary of all watering for a specific station, including all programs in which it will run.



### CHANGING SEASONAL ADJUST

Season adjust is used to make global or program specific run time changes without the need to reprogram every station's run time. Seasonal adjust made at the controller level is global (GLBL), and the controller can be adjusted in 1% increments, from 1 to 300%. This will change run times by the set percentage.

For example, a 10 minute run time that is adjusted to 70% will run for 7 minutes. When the controller is set back to 100%, the station will return to a 10 minute run time.

Programs that are set to GLBL will use the Global Seasonal Adjust setting that has been set for the controller.

It is also possible to set Seasonal Adjust percentages for individual programs (also 1–300%). The programs will use their own percentages and will not be affected by the controller-level Global Setting. The percentages are not multiplied together. If the controller is set to 150%, but an individual program is set to 70%, the stations in the programs will run for 70% of the original run time, not 70% x 100%.



Turn the dial to the SET STATION RUN TIMES position.

### Using the Global Setting

1. Press the left arrow button until the cursor is on the percentage below the GLBL. The percentage immediately below GLBL is the seasonal adjustment percentage for the entire controller.
2. Press the + and – buttons to adjust the global seasonal adjust value between 0 and 300%.

### Using a Program Specific Setting (set Season Adjust by Program)

1. Press the left arrow button until the cursor is on the GLBL.
2. Press the + and – buttons to adjust the season adjust value between 0 and 300%.

NOTE: If it is desired to return to the global season adjust, move the cursor to the season adjust percentage then use the + and – buttons to change the value to GLBL. GLBL is located between the 101 and 100% positions.

### Timed Delay between Stations

Programming this feature is explained in the Extended Features section.

### SETTING DAYS TO WATER

Each Program's days to water are programmed at this position.

### Set Days to Water

1. Turn the dial to the SET DAYS TO WATER position
2. Select the Program (A – F) by pressing the Program button
3. Press the + or – buttons to change from DAYS (day of the week), INTERVAL (1 – 31 DAYS), or ODD or EVEN days of the month.

### Day of the Week Watering



1. Select the Program and DAYS .
2. Press the down arrow button to move the cursor to Monday
3. Press the + button to water on Mondays or the – button to not water on Mondays
4. As the cursor moves from day to day, press the + or – button to water or not water on that day of the week. Press the right and left arrow buttons to move quickly to a specific day.

### Interval Watering



1. Select the Program and INTERVAL with the + or – buttons.
2. Press the down arrow button to Interval
3. Press the + or – button to select the number of days between watering
4. Press the down arrow button to Next Water
5. Press the + or – button to select the number of days until the next watering. If Next Water has "0 days" for a value, that indicates that any scheduled watering for that day will water at its programmed start time. If it has a value of "1 Day," the scheduled programming will water tomorrow.

**Non-Water Days:** This feature can be used to omit watering on mowing days, etc. The days with N will not water, even if they would normally occur at one of the Interval days set above.

1. Press the down button to MON
2. Press the right and left arrow buttons to move the cursor between the days

3. Press the – button when the cursor is on a day that you do not want to water. An "N" will appear, to show that day is never able to water, regardless of the schedule.
4. If you select Odd or Even while in the Interval schedule, the Odd or Even days will not be watered even if they happen to be one of the Interval days to water.
5. To change a non-water day back to a water day, use the arrow buttons to go to that day and press the + button. The "–" will disappear, and the day will be available for Interval watering again.

### Odd/Even Watering



1. Select the Program and ODD/EVEN with the + or – buttons, as shown above in First Step
2. Press the down arrow button once, to select Odd or Even.
3. Press the + or – button to toggle between ODD or EVEN day watering

**Non-Water Days:** This feature is frequently used to omit watering on mowing days, etc.

1. Press the down button to MON
2. Press the right and left arrow buttons to move the cursor between the days
3. Press the – button when the cursor is on a day that you do not to water. An "N" will appear, to show that day is never able to water, regardless of the schedule.
4. To change a non-water day back to a water day, use the arrow buttons to go to that day and press the + button. The "–" will disappear, and the day will be available for Odd or Even watering again.

### SETTING PUMP AND MASTER VALVE OPERATION

Two items are programmed at this position:

- Pump or Master Valve (P/MV) operation by station. Each station may have any combination of P/MV outputs 1, 2, both, or neither, which will activate as specified whenever the station is turned on.



- Extended Feature: Change the master valve from the default of normally closed (N.C.) to normally on (N.O.) Change the location of the P/MV between Controller (wired directly into the Master Module) and ADM (P/MV is connected to a decoder on the two-wire path)

### Set Pump and Master Valve Operation

1. Turn the dial to the SET PUMP OPERATION position
2. Press the right and left arrow buttons to move between P/MV 1 and P/MV 2
3. Press the up and down arrow buttons to change the station number
4. Press the + or – button to enable or disable the specific Pump or Master Valve for the given station

### Changing from Normally Closed to Normally On and Location of P/MV

Programming this feature is explained in the Extended Features section.

### SETTING STATION CYCLE AND SOAK DURATIONS

Each Station's Cycle and Soak settings are programmed at this position. Cycle and Soak allows the user to break up the total run time of a station into more usable watering durations (cycles), and a minimum soak time between the watering cycles. This feature is great to use on slopes and tight soils because it puts the water down more slowly, helping to prevent run off.

### Set Station Cycle and Soak Durations



1. Turn the dial to the SET CYCLE AND SOAK position
2. Press the up or down arrow keys to change stations
3. Press the right and left arrow buttons to move between hours and minutes and cycle and soak

4. Press the + or – button to change the Cycle cursor value. The default cursor value is N/A. Cycles can be set from 1 minute to 6 hours.
5. Press the right arrow button to move from Cycle to Soak, once a value has been entered into the Cycle field.
6. Press the + or – button to change the Soak cursor value. The default cursor value is N/A. Soaks can be set from 1 minute to 9 hours.
7. Press the down arrow to move to the next station.
8. The Copy and Paste functions are useful for large numbers of stations with similar Cycle and Soak requirements. To use, set a station's Cycle and Soak information, then press the Copy button.
9. Use the up or down arrows to advance to the next station, and press Paste. Both the Cycle and Soak value will be pasted into the fields.

You can continue to advance through the stations with the up or down arrows, and press Paste to continue pasting the same Cycle and Soak values into subsequent stations.

### CYCLE AND SOAK SUMMARY

In the Set Cycle and Soak dial position, press the Information button to view a summary of Cycle and Soak with any selected station's run time. It will display the total run time of that station per Start Time in the program, not including the soak time. It will also display the station's programmed cycle time and soak time, and the number of cycles that station will incur due to the programmed runtime and cycle time. If the station's run time is less than one complete programmed cycle time, the number of cycles displayed will be shown as 0+. To view Cycle and Soak summaries for stations in other programs, simply release the Information button and while in the Cycle and Soak screen, hit the Program button. Hold down the Information button again and the display will now show that station's Cycle and Soak summary for the new program.



# SETTING FLOW MONITORING.....

The ACC is capable of monitoring, learning, and reacting to Real-Time flow. The installation of the optional Hunter Flow Sensor (HFS) or a Data Industrial flow sensor is required for this feature to function. The ACC must first learn the normal flow, by station, for flow sensing to operate correctly.

## Step 1: Select The Flow Sensor



Press and hold the INFORMATION button while you turn the dial to the SET FLOW MONITORING position. Press the down arrow button once so the cursor blinks on SELECT FLOW SENSOR.

Press the plus button until the correct HFS FCT size is displayed. HFS sensors are always installed in a Hunter FCT fitting, and selecting the fitting size automatically sets calibration for sensor (see sensor installation instructions).



Location is normally set to Controller. If the controller has a ADM99 decoder output module installed and you wish to connect the Flow meter to an ICD-SEN sensor decoder, use the arrow button to move to Location, and change with + or - buttons to ADM. This will assign the single Flow Meter to an ICD-SEN decoder down the two-wire path, instead of the Flow terminals on the controller's master module.

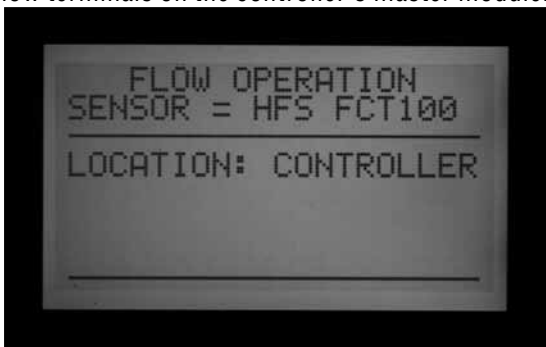

If you are using a Data Industrial or similar Flow Sensor, press the plus button until OTHER is in the display. Then use the plus, minus and arrow buttons to set the K-Factor and Offset. These values can be found in the Data Industrial or similar suppliers' literature.

Once the flow sensor is selected, turn the dial off the SET FLOW MONITORING and the flow sensor that has been selected will be shown.

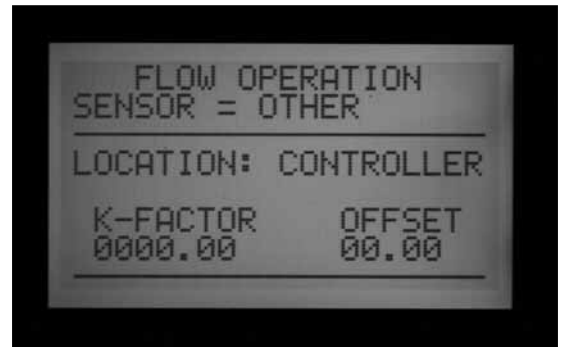

Menu Choices: FCT size	Pipe diameter	Pipe Class
100	1"	Sch. 40
150	1½"	Sch. 40
158	1½"	Sch. 80
200	2"	Sch. 40
208	2"	Sch. 80
300	3"	Sch. 40
308	3"	Sch. 80
400	4"	Sch. 80
OTHER	K-factor & offset	K-factor & offset





**Step 2: Viewing Real-Time Flow**

1. Once the flow meter is configured, ACC can display real time flow. Turn the dial to the Run position, and press and hold the Information button.
2. The display will show which stations, if any, are running, the current flow (in gallons or liters per minute, depending on your Unit of Measure settings), and the Flow Limit allowed.

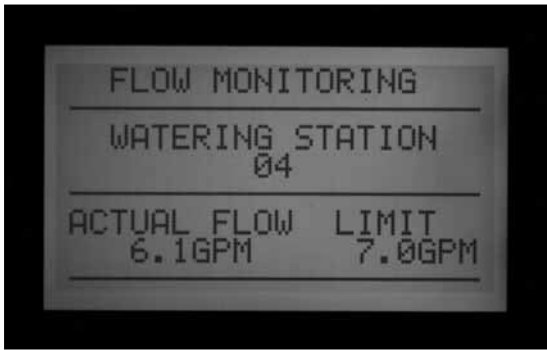

3. The actual flow display is not updated “live” while the blue Information button is pressed. To see an updated view of changing flow conditions, release the Information button, and press again after a few seconds.

To see a live flow status that is continuously updated, turn the dial to Advanced Features and select Utility Functions (version 4 facepack firmware or later). Select View Sensor Status. This will show Flow by location, and a continuously updated actual flow amount.



4. If some individual stations do not have learned flow, the display will show Flow Not Learned at the top, when the Information button is pressed with the dial in the Run position. When a station with no learned flow is running, flow monitoring is temporarily disabled. This is because the controller will not be able to account for any flow caused by an “unlearned” station. To run stations without learned flow, and without disabling the Flow Monitoring feature, set the stations to “Not Monitored” from the Edit Learned Flow function (Extended Features, Set Flow Monitoring position). This is useful for non-irrigation devices such as lighting that may be controlled by the controller stations.



- If the flow sensor selection has been changed to NONE after learning, the display will show FLOW NOT MONITORED. The actual flow may still be viewed, even if all stations have been set to Not Monitored. Station level alarm diagnostics would not be available, but the flow will be visible.

### Step 3: Preparing for Flow Learning

- ACC will only learn flows for stations which have run times in Automatic Programs. Verify that each station has a run time in an Automatic Program (A through F).
- ACC can be taught to ignore flow monitoring for stations which operate non-irrigation devices.
- Turn the dial to another position, then hold the Information button while turning back to the Set Flow Monitoring position.

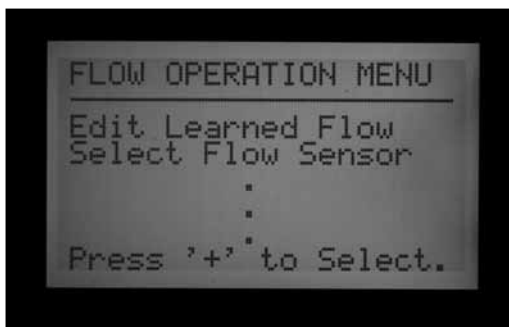

- Select Edit Learned Flow (even if no flow has been learned, yet).
- Use the – button to set the non-irrigation stations to Not Monitored. Use the up and down arrow buttons to advance through the stations, and set any stations necessary to the Not Monitored setting.



### Step 4: Learning the Flow

- Turn the dial back to the RUN position.
- Press the LEARN button. The screen will display that the controller will run the stations and it will also ask you to confirm that you want to begin watering to learn flow.

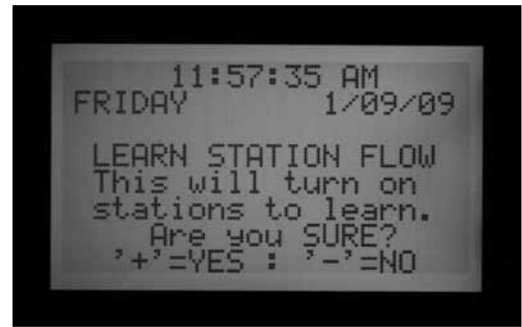

- The ACC will begin watering at the lowest station number to learn its typical flow. Normally this will be station 01, unless it is Not Monitored or has no run time in any programs.



It will run the station for a minimum of 15 seconds, and then begin sampling flow at 5-second intervals until flow has stabilized (at least 4 readings, 5 seconds apart, within a reasonable flow range of one another). It will then store the average flow for this station in its memory, and move on to the next station. It will continue in this manner through all stations which have at least one run time in one of the Automatic Programs, and which are not set to Not Monitored in the Set Flow Monitoring station settings.



Only stations with a run time in an Automatic Program will be learned. Stations which are not programmed in any Programs will not be sampled, and should be set to Not Monitored to ensure proper operation of the flow meter.

If the station Delay setting has been changed, the controller will run the station for Delay period (instead of the 15 second minimum) before sampling and learning flow.

- It may take a full hour or longer to learn flows for an entire 42-station controller. Each station may take from 35 seconds to 5 minutes to be learned, depending on stability of the flow.

### Step 5: Review And Edit Flow

The flow values and settings for each station can be reviewed, and manually edited, at the Set Flow Monitoring dial position. It is important to verify the flow settings for each station before leaving the controller in automatic operation.

- Turn the dial to the Set Flow Monitoring position.
- Use the up and down arrows to navigate through all stations, and verify that they have a learned flow or a Not Monitored setting.
- Do not leave any station with a "Not Learned" message—either enter a flow manually, or set it to Not Monitored.



- To edit a station's flow data, turn the dial to any other position, hold down the Information button, and turn the dial back to the Set Flow Monitoring position. Select "EDIT LEARNED FLOW."
- Use the up and down arrow buttons to move through each station.
- Use the +/- buttons to adjust the flow. Each station can be set from 0.5 GPM (1.9 LPM) to 999.5 GPM (2770LPM) in 0.5 GPM /1.9 LM increments. Between the highest value (999.5) and the lowest (0.5/1.9 LPM), the Not Learned and Not Monitored choices also appear, as the +/- buttons are pressed.

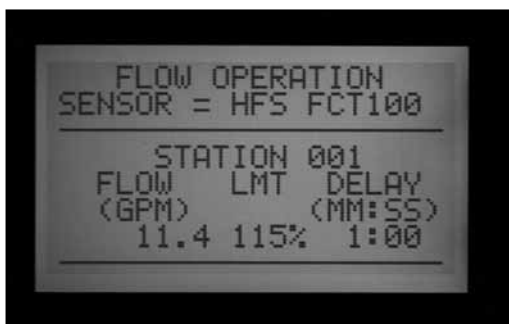

You can manually replace a Learned flow with another value, if you wish.

- LIMIT: Use the left and right arrow buttons to move to the Limit field (LMT) to edit it, if desired.

The default Limit is always 115%, meaning the station must exceed the flow by 15% before it will be treated as an alarm (to prevent false alarms due to normal flow fluctuations). 110% is the minimum possible Limit setting, and 300% is the maximum.

- DELAY: Use the left and right arrows to move to the Delay setting to edit it, if desired.

The default delay is 01:00 in minutes:seconds format. This means the station's flow will be ignored for the first 1:00 of operation, before the flow will be considered for alarm purposes. The Delay can be set from 0:15 to a maximum of 9:59. Some delay is recommended to prevent false alarms, particularly when stations are initially activated.

You can Copy and Paste to edit flow settings for multiple stations with similar characteristics. Select the station with the Flow you wish to copy and press the Copy button. You may then Paste (Paste button) the flow value into any other stations.

The Limit and Delay settings may also be copied and pasted together, separately from the Flow Value.

- Review all stations to verify their flows, limits, and delays.
- Once station flows have been learned, flow monitoring is in effect. If the Information button is pressed during irrigation, the actual flow will be shown, along with the combined limit of all active stations.
- Stations that do not operate irrigation devices, and stations that are not used, must be set to Not Monitored to avoid false alarms.

### FLOW ALARMS

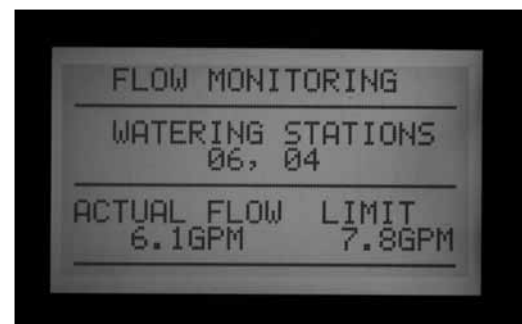

When a Flow Alarm has been detected, the controller will begin diagnostics, which can be seen in the display.

The controller will shut down all station activity for 1 full minute. The display will show the stations as Paused during this interval.

The controller will then test each station that was running at the time of the alarm, individually. It will start the lowest-numbered station that had been running, and allow it to run for the Delay period set in Set Flow Monitoring. After the Delay has elapsed, it will sample the flow rate, to see if it is within the Flow Limit.

If the station passes (runs within the Limit), the controller will Pause the station, and move on to test the next station that had been running (if applicable).

If the station fails, (runs outside of the Limit), the station's run time will be ended, and an alarm message will be placed in the Alarm Log.

The display will show ATTENTION: Flow Alarm if any stations have failed the test. Irrigation (for passing stations) continues to run normally, even if this display is present.

Details for the stations that failed, including time of day and Over or Underflow, will be stored in the Alarm Log (Data History dial position).

To get detailed information about any Attention display, turn the dial to Data History and select the Alarm Log.



After irrigation is completed, the display will continue to show that alarms occurred, until any button is pressed. This will usually result in multiple flow alarms since ACC will try to restart stations after Pausing for one minute.



Since ACC can run multiple stations at once (Overlap, SSGs, etc.), it will add up the learned flows for all stations that are running, and compare the total to the actual flow, in real time. If an alarm occurs with multiple stations, ACC will enter a diagnostic mode to try to isolate the problem stations.

All station delays must be met before the alarm will occur. If multiple stations are running and have different delay times set for Flow Alarm limits, the longest delay must be met before the alarm will occur.

To view the diagnostics while they are in progress, press the Information button. This will clear the Attention, Flow Alarm display and show the actual status of the affected stations. While isolation is in progress, the display will then show individual stations in Pause status, as each station's flow is sampled one at a time.



## ALARM LOGS

See Data History on page 38 for more information.

When a Flow Alarm is shown on the display, turn the dial to Data History to view the Alarm Logs for an explanation of the alarm (select Alarm Logs and press +).



The Last Event is always shown first. Press the – button to step backwards through the logs to view them one at a time.

A Missed Irrigation report will be logged for each station event that causes a station to shut down for Overflow or Underflow reasons. The report will show the date and time of the event, and which type of flow alarm occurred (Over or Under).



### TIPS ON FLOW ALARMS

- There is only one flow meter per ACC controller, and controllers do not share information with one another. If a controller with a meter “sees” flow caused by another controller, drawing water from the same point of connection to the water supply, the controller will experience many false alarms, because it cannot account for the flow. Do not combine controllers on the same point of connection.
- Most false alarms occur because the Limit % is set too close to “normal” or learned flow. Irrigation systems often experience fluctuations in the amount of flow and increasing the limit % reduces the possibility of false flow alarms.

- The primary purpose of Underflow alarms is to protect a Pump from deadheading, if a station has failed to open. If a station that has learned flow is activated for test purposes without turning on an actual valve, an Underflow alarm may occur. This is normal.
- When two stations are running together with very different flows, such as a high volume spray or rotor zone running together with a low-volume drip zone, it is possible that an alarm condition on the low flow zone may be missed. This is because the Limit % of the high flow zone may include the entire flow range of the low flow zone. For example, a 40 GPM zone with a limit of 115% needs to see 46 GPM to alarm. If it is running together with a 4 GPM drip zone set to 115%, the drip zone could exceed its alarm limit (4.6 GPM) but the total would still be under the combined alarm limit for both stations.

## SETTING CLIK™ SENSOR OPERATION .....

The ACC is capable of monitoring four individual Clik-type sensors, in addition to the flow sensor. Typically these sensors are weather-related sensors such as the Mini-Clik® or Rain-Clik™ rain sensors, the Freeze-Clik® temperature sensor, or the Wind-Clik® wind sensor.

Each Program has three response options. OFF, SUSPEND or PAUSE.

ACC version 4 or later is also capable of monitoring an ET Sensor as an alarm input, and may also receive Clik (and Flow) sensor inputs via an ICD-SEN sensor decoder. These options are enabled with the extended features at Set Sensor Operation for setting Locations. *See Sensor Locations on page 35 for more information.*

Each sensor (1–4) will also show its current state, as either ACTIVE (in alarm) or INACTIVE (normal or no alarm). ACC sensor inputs are normally closed. An open sensor is ACTIVE and shows an alarm condition.

- OFF indicates that the sensor will not respond to that sensor. If the selection is set to "OFF," the current state will always be shown as "Active," unless a sensor is connected to the sensor terminals. In that case, the state will change to "Inactive," because the circuit will be closed. The programs will still ignore the sensor, however, because the setting is set to "OFF."

- SUSPEND indicates that the program will stop any current watering, and inhibit watering from beginning should a start time pass. If a SUSPENDED Program is resumed, it will resume where it should be in “real time”. The stations that were missed will not irrigate, but the Program will end at its normal time.



SUSPEND is the recommended setting for irrigation programs when a sensor shutdown is desired.



PAUSE indicates the controller will stop watering until the sensor allows watering again (resets to normal state).

PAUSE should be used with caution! Paused watering (caused by a sensor) never expires. It is held in memory until the sensor returns to the normal position (normally closed), and then the watering events will be allowed to run whenever this occurs. This may cause unexpected behavior. This is different from the manual Pause (pushing the Pause button), which will time out in 30 minutes automatically

Watering that is Paused by a sensor alarm will technically remain forever (up to 10 start times worth will be stored), and will resume when the sensor becomes normal or inactive again.



### SET SENSOR OPERATION

1. Use the Program button to select each Program and set the sensor responses. Each Program must have a response set individually for shutdowns. If it is necessary to shut down the entire controller on the sensor input, insure that all 6 Programs (A-F) have shutdowns set for the sensor.
2. Use the Up and Down arrow buttons to move through the individual sensors.
3. Use the +/- buttons to select the response to each sensor for that program.
4. Use the Program button to advance to the next Program and set its responses.

Once a response (SUSPEND or PAUSE) has been set for a Program, all sensor responses must either be the same, or Off. A Program cannot be both Paused and Suspended at the same time.

If a Pause response is set for Program A to Sensor 2, then Pause is the only response that can be set for Program A. Changing Sensor 3 to Suspend A will cause Sensor 2 to change to Suspend A.

If the entire controller is required to shut down on an individual sensor input, each program (A-F) must be individually set to Pause or Suspend for that sensor.

Depending on how many sensors you are installing, only change the sensor response to pause or suspend according to sensor number one. Do not change the response for sensor two, three and four. This will cause the controller to engage in numerous sensor alarms. In a different scenario, if the sensor response is changed to pause or suspend, and the sensor has not been connected to the corresponding sensor terminals, the state change will remain active, indicating an open circuit. This too will cause a sensor alarm.

: Only change the sensor responses to pause or suspend for the Sensor inputs that are in use.

Example: If you only have one sensor, and it is wired into sensor input number one, set the response for Suspend or Pause, according to sensor number one. Do not change the response for sensors two, three, and four. Leave them set to Off.

Example #2: In this scenario, a Rain-Clik™ is connected to Sensor 1. It will Suspend the sprinkler stations in programs A through E when active.

Sensor 2 has a photo sensor connected, which will Suspend only Program F (which can be used for items like lighting, via 24VAC relay). The Rain-Clik™ sensor will not affect the lighting, and the photo sensor will not affect the sprinklers.

Programs	A	B	C	D	E
Sensor 1	Suspend	Suspend	Suspend	Suspend	Off
Sensor 2	Off	Off	Off	Off	Suspend
Sensor 3	Off	Off	Off	Off	Off
Sensor 4	Off	Off	Off	Off	Off

# SENSOR ALARMS (CLIK SENSORS SEN 1-4 ONLY).....

Whenever a sensor alarms (changes to Open from its Normally Closed state), an ATTENTION message appears in the display if a program response has been configured for that sensor.

Details for each sensor alarm will be found in the Alarm Log (Data History dial position). If the sensor response is changed to Pause or Suspend, and the sensor has not been connected to the corresponding sensor terminals, the sensor will remain active, and cause a sensor alarm.

If a Program configured for shutdown by that sensor was active when the alarm occurred, it will either Suspend or Pause as configured.

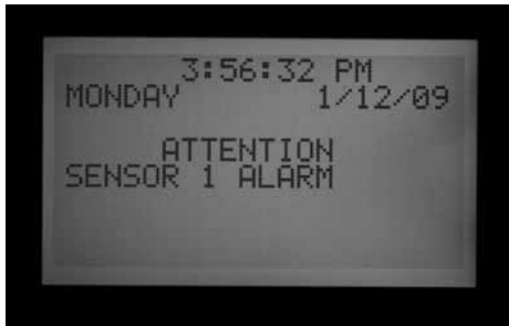

## CLEAR MESSAGE



If the sensor is set to OFF for all programs, it will not cause an alarm or ATTENTION display.

However, the state of the sensor may be observed at the Advanced Features dial position, Utility Functions, and then View Sensor Status. The screen will explain if the sensor is in a closed or open state. If the sensor's response was set to suspend or pause in the Set Sensor Operation dial position, the display will also show an alarm message in this screen if the circuit is open. You can also see the state of the sensor, even with the sensor response set to "OFF," in the Set Sensor Operation dial position.

Press the + button to clear the alarm message, and view the status of the programs. Pressing + only clears the message, not the alarm. The display will then show the status of Programs in response to the sensor.

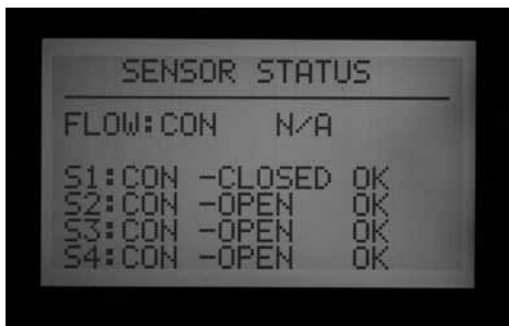

Programs that were Suspended will continue to show the stations and count down the time remaining, but will say SUSPEND along with automatic program letter and no watering will occur. If the sensor is reset, they will resume watering instantly where they should be in real time.



Programs that were Paused by the sensor will show the Program letter and Pause, and the time remaining will be frozen. No count down occurs because events are Paused. If the sensor is reset, the Paused Programs will resume instantly, wherever they left off when the alarm occurred.

Sensor alarms have no effect on Manual Single-station starts that are running.

Sensor alarms have no effect on Custom Manual programs.

Sensor alarms have no effect on the Test program.

All of these types of programs are initiated by a human operator so the sensor settings do not apply.



Note: Sensors have no effect on Surveyor generated System Events, or System Manual Events, when operating in Event mode. Sensor shutdowns are designed to be transmitted from the central in Surveyor systems. If an automatic Program (A-F) was started Manually, it will be shut down by an active sensor that is configured to shut down that program.

The sample display on the right shows a single active sensor alarm in process, with a range of possible responses. The operator has pressed the + button after the FAULT display, to view controller status.



Station 02 was running in Program A, and that Program has been Suspended (the seconds timer would still be counting, but watering would be stopped).

Station 06 was running in Program B, and has been Paused. The seconds timer would be frozen (and watering would be stopped).

Station 05 was running in a Custom Manual program, and the sensor would have no effect on it. Station 05 would still be watering in Custom Manual 1.

There is no direct Override for a Klik sensor. Depending on what needs to be accomplished, the Test program is still available (for winterization functions) and individual stations can still be started from the Manual position.

If a sensor is alarmed, and a Manual Program start is attempted for a Program with a response for that sensor, the display will show "CANNOT RUN MANUAL. A sensor is active for this program." That program cannot be manually started until the sensor is reset.

If the Manual Program was running prior to the state change in the sensor, the Manual Program will be put into either Suspend or Pause mode. The Manual Program will resume if the state of the sensor changes back to a closed circuit while there is still time left on the program. If the program that you are trying to manually run is not set to a Suspend or Pause response for the alarmed sensor, the Manual Program will be able to run manually.

If the Manual Program was running prior to the state change in the sensor, the Manual Program will be shut down and be put into either Suspend or Pause mode. The Manual Program will resume if the state of the sensor

changes back to a closed circuit. If the program that you are trying to manually run is not set to a Suspend or Pause response according to that sensor, the Manual Program will be able to run manually.

If full operations must be restored when a sensor is in alarm, turn the dial to the Set Sensor Operation position, and use +/- to change the sensor response to Off (by program).

View recent alarms, or alarm history, by turning the dial to the Data History position and selecting Alarm Logs *See Data History on page 38 for more information.*



## SENSOR LOCATIONS

ACC versions 4 and later support two additional types of sensor inputs.

- ICD-SEN Sensor Decoders: Standard "klik" sensors (as well as the Flow meter) may be connected to ICD-SEN decoders in the two-wire path. The controller still has 4 sensor inputs, but you may set the location of each sensor to Controller (for the terminals on the controller's master module) or ADM (the decoder output module is called ADM99, and setting a sensor to this location means the input is assigned to a sensor decoder).



- ET Sensor: A Hunter model ET Sensor may be used for certain alarm inputs. The ET Sensor is a sensor platform, and three of its individual sensors can be used as sensor inputs for alarm purposed to the ACC Controller. The controller still has four sensor inputs, but you may set the location of each sensor to Controller (terminals SEN 1–4 on the controller's master module) or ET (Rain, Wind, and Temp). If the controller has a decoder output module, the third choice ADM will also appear.



Assigning sensor locations is called "mapping" and tells the controller where to look for each of its four sensor inputs.

Mapping sensor locations is the first step to setting up ICD-SEN operation, and is also an optional step in setting up ET Sensor operation.

To map sensor locations, unlock the extended features by holding down the blue information button, and turning the dial to Set Sensor Operation.

The Sensor Configuration screen will show the locations of each sensor, one at a time.

Type and Style cannot be changed. Most sensors are CLICK type and N. C. (normally closed) style.

Location: Use the down arrow to move to the Location field.

Press the + or – buttons to view other choices for the sensor's location.

If an ADM99 decoder module is detected by the controller, the choices will be Controller or ADM.



If an ET Sensor has been detected and the controller has been programmed to "Use ET Sensor" within the Advanced Features dial position, the choices will include ET Rain, ET Temp, and ET Wind.

Select the sensor's Location with the + or - buttons.

Press the up arrow button to move back to the Sensor number, and use + or – to move to the next Sensor.

Assign each sensor input that is to be used to the correct location. When you are finished, turn the dial to another position. If some sensors are unused, leave them set to Location: Controller.



## SENSOR LOCATIONS

Individual ET sensors can be used to perform alarm shutdowns, by assigning them to the Sen 1-4 positions in the controller. The ET Sensors will then function exactly like “Clik” Sensor inputs. They may have Suspend or Pause responses set by Program.

Assigning ACC Sensor 1-4 alarm functions to an ET Sensor is done without connecting any additional wires. The controller will use the sensor data as a virtual alarm.

ET Sensor shutdowns only apply to the controller to which the ET Sensor is connected.

The ACC cannot shutdown other controllers as a result of these alarms.

ET Sensor shutdowns are not instantaneous, and there may be a delay of up to 18 minutes between an ET Sensor alarm and the actual shutdown. If this is not acceptable, a separate sensor (such as Rain-Clik or Freeze-Clik) should be installed and wired directly to one of the Sen 1-4 inputs for instant shutdowns.

The controller will automatically check the ET Sensor for updated sensor readings every 15 minutes. If an ET sensor causes a controller Pause or Suspend, that action will remain in effect for at least 15 minutes until the controller updates the readings. If the sensor returns to normal the Suspend or Pause settings will be cancelled, as with any other sensor.

**Note:** ET functions will only appear as a Location option with the updated versions of the facepack firmware (4 or higher), and an updated ET-ready Master Module. Once the controller is equipped with these components, ET must then be enabled in the programming. Turn the Dial to Advanced Features and select “ET Functions.” Select “ET Operation,” and press the plus button to confirm that the controller will “Use ET Sensor.” The ET location option will then be available to choose as a location for the controller’s sensors.

When the controller is set to “Use ET Sensor,” more options are also unlocked within the Advanced Features “ET Functions” screen. One of these unlocked screens is labeled “ET Alarm Setup.” Use the Down arrow to move to the “ET Alarm Setup” screen. Press the plus button, and you can adjust the shutdown levels for Rain, Temperature, and Wind.

**Rain Max:** The maximum amount of rain that will be permitted before a program is shutdown for the rest of the day. Move to this position with the arrow keys and use +/- to set the maximum.



The ET Rain sensor will shutdown programs after 0.02” (0.51mm) of rainfall within an hour (this amount is not programmable), but the program may be permitted to run again if no more rain is detected. The ET Sensor checks for rainfall every 15 minutes.

If the Rain Max amount is reached, the controller will no longer attempt to run the program that day.

**Temp:** The air temperature can be used as a freeze sensor to stop automatic programs, and the temperature at which shutdown occurs is programmable (from 25° to 45° Fahrenheit, -3.8° to 7.2° Celsius). Move to this position with the arrow keys and use +/- to set the low temperature shutdown.

**Wind:** If the optional ET Wind is installed, the wind speed (in mph or kph) can be used to shut down designated programs.

**Reminder:** Alarm settings are not in effect until the Sensor 1-4 inputs have been assigned to them at the Set Sensor Operation dial position, and responses have been configured by program.

# SETTING PROGRAM OVERLAP OPTIONS.....

There are three program overlap options. These options allow you to maximize the number of stations operating simultaneously, if the system's hydraulics can support the flow.

To program the Program Overlap option:

1. Turn the dial to the SET PROGRAM OVERLAP OPTIONS position
2. Use the Up and Down buttons to navigate to changeable portions of each display.
3. Use the +/- buttons to see and set the choices.

Once the Program Overlap Option has been selected for the controller, individual programs can be set to Overlap or Stack at the Set Program Start Times position.

## OPTION ONE: STACK OR OVERLAP

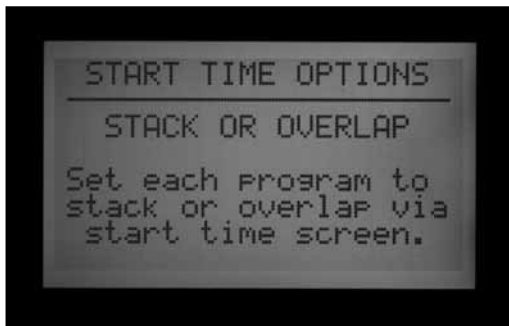

STACK means that the programs will run in alphanumeric order by Program letter and start time chronology. STACK is the default.

OVERLAP means that each program will start at the time it is scheduled to start, regardless of what else is watering. This is true under the condition that each program is set to Overlap. If Program A is set to Overlap and Program B is set to Overlap, both programs will start at the time they are scheduled to start, and run at the same time. If Program A is set to Overlap, and Program B is set to Stack, Program B will NOT run at the same time. Program B will not come on until Program A is finished with its scheduled run time. If you want multiple programs to water at the same time, each one of those Programs needs to be programmed to "Overlap."

Leaving this setting in the "Stack or Overlap" position means that each program can be set to Stack or Overlap, individually.

The OVERLAP option does not allow for multiple stations within the same Program to OVERLAP, or water at the same time. Only different programs may OVERLAP and run at the same time.

A more detailed explanation of this option can be found in the Setting Program Start Times section of this manual.



## OPTION TWO: SMARTSTACK™



SmartStack will limit simultaneous operations to the number of stations specified here. The operator may program as many overlapping programs as desired, and the controller will permit overlap up to the number specified here, and stack the rest.

- SmartStack allows from two to five stations to operate simultaneously, before forcing additional stations into a stacked queue.
- Use the up and down arrow buttons to move to the number of stations allowed (after choosing SmartStack).
- Use the +/- buttons to set the number of stations allowed to overlap.

This is a great way to minimize the watering window by allowing the controller to run at maximum electrical capacity, if you have sufficient water pressure and flow to support multiple programs.

## OPTION THREE: SSG/SMARTSTACK™



See SSG (Simultaneous Station Group) Setup on page 47 for more information..

An SSG (Simultaneous Station Group) is a group of up to four stations that water at the same time, for the same duration. Any 2 to 4 stations can be placed into an SSG, and from that time on, they will be programmed and operated as a single unit.

Combining stations into SSGs shortens programming time, and can also shorten watering time (by running multiple stations at once). SSGs should normally combine similar stations, with similar watering needs and flows, to be used to their best advantage.

When using SSGs, the controller can electrically only handle one SSG, two stations, and two Master Valves simultaneously, maximum. You must choose this option if you plan on using SSGs.

If SSG/SmartStack is chosen:

- Use the up and down arrow buttons to navigate to the number of stations (allowed to overlap with an SSG).
- Use the +/- buttons to set the number of stations permitted to overlap an SSG.
- Since an SSG may contain up to 4 stations, setting this number to "1" means that up to 5 stations may run at once (up to 4 in the SSG, plus one additional station). Setting the number to "2" means that up to 6 stations may run at once. Setting this to 0 means SSGs must run by themselves and may not overlap individual stations.
- ACC does not adjust overlap and stacking for SSGs which have fewer than 4 stations in them... it assumes that all SSGs have four stations, and the number of stations allowed with an SSG applies, regardless of the SSG's actual size.
- If the Program Overlap option has been set to SSG/SmartStack with a limit of 2, and an SSG is activated manually, the controller will assume the SSG may have up to 4 stations, and therefore, only 2 other stations will be permitted to run at the same time manually.
- Once a station is programmed into an SSG that station that may not have a run time by itself in any other program.

**CAUTION:** Understand your irrigation system's hydraulic restrictions before allowing stations to Smartstack or SSG/SmartStack. Overlapping stations may overtax the hydraulics of your system. Overtaxing your hydraulics will damage the components and result in inferior sprinkler performance. Mixing dissimilar stations in SSGs may cause over or underwatering of certain plant types.

## SET STATION & PROGRAM NAMES

All set Station and Program names of the ACC can be named for easy reference. This can either be setup via the IMMS central control software, or it can be programmed at the controller using the keypad. The Contact Info screen can also be programmed at this position. This sets the display which appears when the controller is turned on, and which also appears in many of the Information screens. The factory default setting is Hunter Industries contact information, but it can be replaced with the company name, telephone number, and/or web site of the appropriate installing or servicing personnel.

## ASSIGN CONTACT INFORMATION

1. Turn the dial to SET STATION and PROGRAM NAMES position. Use the +/- buttons to select a letter, number, or character for each letter position. It is possible to reprogram a character right over the existing text.



2. Hold the + or - button down continuously to advance rapidly through all choices, including capitals, lower case, numbers, and characters.
3. Use the left and right arrow buttons to advance to the next character position, and select the next character.
4. Continue until the line is complete. Use the arrow buttons to move down and reprogram each line.
5. Turn the dial to any other position, at any time, to save the text in the Contact Info screen.



6. Turn the dial to any other position, at any time, to save the text in the Contact Info screen.

## DATA HISTORY .....

### **Name a Program (Up to 12 Characters and Spaces)**

1. Turn the dial to the SET STATION & PROGRAM NAMES position.
2. Press the PLUS button once.
3. Use the up and down arrow buttons to select the program you wish to name.
4. Use the plus and minus buttons to select the letter or symbol you wish to use.
5. Press the right arrow button to advance the cursor and then repeat, using the plus and minus buttons to select the next letter or symbol.
6. Repeat until the name is completed.



### **Name a Station (Up to 12 Characters and Spaces)**

1. Turn the dial to the SET STATION & PROGRAM NAMES position.
2. Press the + twice or the - button once.
3. Use the up and down arrow buttons to select the program you wish to name
4. Use the plus and minus buttons to select the letter or symbol you wish to use first, press the right arrow button to advance the cursor and then repeat using the plus and minus buttons to select the next letter or symbol. Repeat until the name is completed.

**Shortcut:** Use Copy and Paste for similar names, and change only the characters that are unique to the station.



5. Turn to any other dial position to save names.

This dial position allows you to view flow totals and various logs containing important histories of all activity.

Flow totals can be viewed for

- The entire controller
- An individual program
- An individual SSG
- Or an individual station.

Controller totals are based on total measured flow. Program, SSG, and station totals are extrapolated and are “educated guesses” that should closely approximate their totals, but they cannot be as accurate as the total Controller flow. Daily totals show decimals of gallons or liters, but weekly and larger totals round up to the nearest whole unit of measure.

Once the flow item is selected you can then view:

- The total for today and yesterday
- Week to date & last week totals
- Month to date and last month totals
- Or year to date and last year totals

When viewing these menu selections, the left arrow button on the facepack will operate as a Back button. Some selections lead to another list of choices, and the Back button will return you to the next highest level, without having to turn the dial.

### **VIEW FLOW TOTALS**

1. Turn the dial to the DATA HISTORY position
2. Press the plus button once.
3. Press the plus or minus button until the item you would like to view is displayed
4. Press the down arrow button to highlight TODAY
5. Press the plus or minus button until the period you would like to view is displayed

### **VIEW ALARM LOGS**

1. Turn the dial to the DATA HISTORY position
2. Press the down arrow button to select ALARM LOG
3. Press the plus button to view the log
4. Press the plus and minus buttons to scroll through the log. Alarms are logged by type of alarm, and time and date of occurrence.
5. The Alarm Log will store up to the last 250 events (the oldest events are replaced by new ones).



Alarm log items labeled “Missed Irrigation” are important, because they have caused stations to not water when they should. The reason for the missed irrigation will always be indicated, as “Overcurrent” (electrical) or “Overflow/Underflow” (hydraulic), etc. A complete list of possible Alarm Log messages appears at the end of this manual.

Each alarm log entry will have the exact time of the occurrence of the missed irrigation event.

### VIEW CONTROLLER LOGS

1. Turn the dial to the Data History position.
2. Press the down arrow button to select Controller Log.
3. Press the + button to view the log.
4. Use + and – buttons to scroll through the log of Controller level events.

The Controller Log will store the last 250 Controller-level events, with date and time stamp. These include critical changes, such as dial turned to OFF position, Controller time reset by user, Easy Retrieve Restore, and other major changes. A complete list of possible Controller Log messages appears at the end of this manual.



### VIEW STATION LOGS

1. Turn the dial to the Data History position.
2. Press the down arrow button to select Station Log.
3. Press the + button to view the log.
4. Use + and – buttons to scroll through the log of Station level events.

The Station Log will store up to 1500 events, and records all station activity, including every start and stop of each station. It may include alarm events if applicable. A complete list of possible Station Log messages appears near the end of this manual.



All logs (Alarm, Controller, and Station) replace the oldest events when they are full, and contain only the most recent events within the controller memory’s holding capacity. They will never fill up, but the oldest records will be overwritten (first in, first out, or FIFO).

All logs are cleared in computerized central systems after the central computer uploads this data as part of its communications. The log will then display NO RECORDS TO SHOW and the logs will be available in the central software, instead.



### ADVANCED FEATURES

This dial position is used to verify the version and size of the controller, and to configure and use some of the ACC controller’s more powerful features.

A list of functions will appear at the Advanced Features dial position, but they will depend on the devices installed in the controller, and the version of the controller.

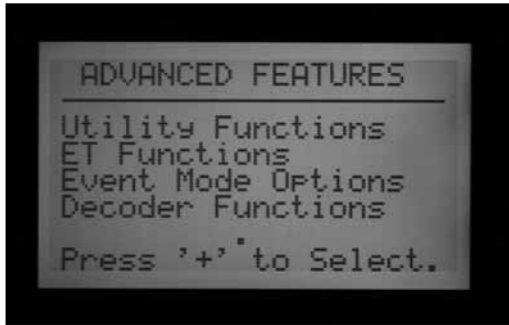

If station size is incorrect, or shows “0” or “1”, check that Powerlock slide is in the ON (locked) position. Check that all station module contacts are in good order and that the modules are fully inserted. Make sure powerlock tabs on front of modules have good contact with the slide lock. An incorrect station count may indicate a damaged module, if it persists after all checks have been made.

When the info button is not pressed, the Advanced Features may show all or some of the following items:

Utility Functions: ET Functions (only if ET Ready Master Module and firmware are installed)

Event Mode Options: *See Event Mode Options (agc, surveyor) on page 75 for more information.* (Golf only).

Decoder Functions (only if ADM99 decoder output module is installed)

When viewing these menu selections, the left arrow button on the facepack will operate as a Back button. Some selections lead to another list of choices, and the Back button will return you to the next highest level, without having to turn the dial.

Select Utility Functions to see the following choices:

View Firmware Versions: Select to see version numbers of all modules in use in the controller.

### VIEW VERSION AND STATION SIZE

Turn to Advanced Features dial position.

Press and hold the Information button.

This will display contact information for help. This information is programmable at the Set Station and Program Names dial position, if you wish to change it.

FP Temp is the internal facepack temperature. It is not used and is informational only.

The Revision number is the version of ACC firmware loaded in the controller. You can download the latest version of firmware from [www.hunterindustries.com](http://www.hunterindustries.com) and flash update the controller facepack from a laptop computer.

Please note this version number whenever asking a question from technical support about the ACC controller.

Station Size: Shows the number of station outputs recognized by the facepack. This does not show how many valves are in the field, or in use. It is the count of station output modules (number of ACM600 or AGM600 modules x 6 stations each), or it will show “99” if an ADM99 Decoder Output module is detected.



View Sensor Status: This will show the location and status of the flow meter and all sensor inputs (1-4). CON means Controller, or the screw terminals for sensor connections inside the controller.





ADM means the ADM99 decoder output module, and shows that the meter or sensor input has been assigned to an ICD-SEN sensor decoder in the two-wire path.

ET followed by a sensor name means the input has been assigned to an ET Sensor.

ET Functions are described in their own section in this manual.

Event Mode Functions are described in their own section in this manual.

Decoder Functions are described in their own section in this manual.

## COMMON ALARM (ATTENTION) MESSAGES.....

### OVERCURRENT

In a conventionally-wired controller with ACM600 or AGM600 outputs, Overcurrent means that the station has exceeded 0.56 Amps output. This indicates that either too many solenoids are connected or the field wiring or solenoid has a problem, causing an unacceptably high current. All solenoids are different and not all solenoids may be “doubled” on an ACC output. A solenoid with a holding current of 0.3 A is acceptable, but two of them (equaling 0.6 A) would exceed the 0.56 A max limit and cause an Overcurrent.



The Alarm Log will indicate whether the alarm was associated with a station number, or "ADM", referring to the ADM99 decoder output module.

A station Overcurrent in a decoder system indicates a high-draw condition on the output side of the decoder, to the solenoids, usually a shorted solenoid.

In decoder controllers, Overcurrent may have more complex causes, but still indicates an unacceptable high current on the decoder line.





An ADM Overcurrent message means the total draw on the two-wire path(s) was greater than 2.2 amps, but the ADM99 was not able to identify a particular station causing the problem.

Any ACC display that shows ATTENTION is indicating an alarm or other condition that should be investigated. You should immediately turn the dial to Data History and select the Alarm Log to view all details associated with the alarm. This will often reveal the real problem at a glance.

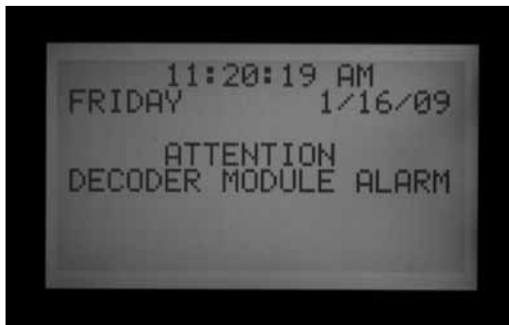

The ATTENTION message in the display will not stop irrigation by itself, but the condition it is reporting may. If a station is in Overcurrent, the station cannot run, but other stations may continue running even when ATTENTION is in the display. Press the information button to clear the ATTENTION message if you want to see the normal status screen.



### OVERFLOW

A station has exceeded its learned flow upper limit during irrigation. ACC totals the upper limit of the learned flow for all running stations, and compares them to the actual flow at the flow meter. When the combination of stations exceeds the total upper limits (after all Delay times have elapsed), the controller will Pause and go into alarm diagnostic mode.

P/MV outputs have a max output of 0.325 A. Pump start relays with very high current requirements may need a dedicated transformer and an additional relay (such as Hunter Model PSRB) for reliable operations.

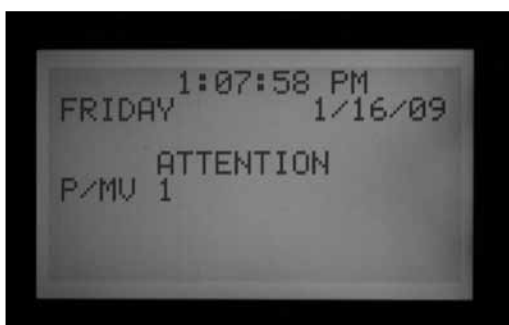



Alarm diagnostics consist of pausing all operations, then starting each station that was running at the time of the alarm individually. Each of these suspect stations has its flow sampled alone, to see if it caused the overflow. If the controller identifies a station as having high flow, it will create a Missed Irrigation report and attempt to continue watering with other stations.

**POWER OUTAGE/POWER RESTORED**

Power Outage and Power Restored messages often appear one after the other, and show when AC power to the facepack was lost and when it is restored. By comparing the dates and times of the messages, you can determine how long the power was off to the controller. Power Outage and Power Restored messages are also caused whenever the facepack is removed from the controller and replaced.



**UNDERFLOW**

A station has caused too little flow, indicating a possible problem. The underflow amount cannot be set directly, but is twice the percentage of the Limit amount set for overflow. If a station is set 115% for the upper limit (normal flow + 15%), then 70% will be the underflow amount (normal flow = 30%).



**EXTENDED FEATURES .....**

**CONTRAST ADJUSTMENT**

At the Run position, press INFORMATION button and + button together.

The contrast of the LCD display can be adjusted from 1 to 90 to make it more visible in different light conditions. In the Run position, press the blue Information button and the + button at the same time for a few seconds, until the Contrast = 50 display appears. The + and - buttons can then be used to adjust the display for maximum visibility.

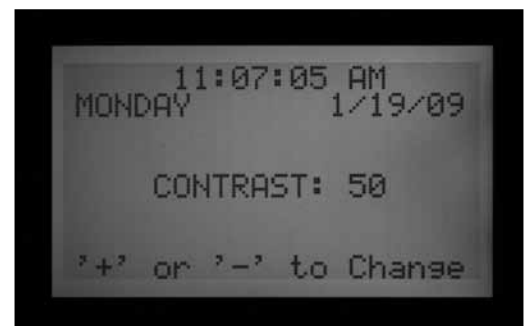

## NO WATER WINDOW

No Water Windows prevent any automatic irrigation from occurring during certain hours, by Program. This can be used to protect high traffic areas from accidental programming, or the results of Seasonal Adjust, during busy times of day.

Start in any other dial position, hold the Information button down, and turn the dial to Set Program Start Times. Release the Information button.

The display will now permit programming of No Water Windows.

### To set a No Water Window

1. Use the Program button to select the program for which a No Water Window is desired.
2. Use the +/- button to set the time for the beginning of the No Water Window ("FROM") in hh:mm format, including AM/PM if applicable.



3. Use the down arrow to move to the "TO" position, to set the end of the No Water Window.
4. Use +/- to set the end of the window, also in hh:mm format.

The No Water Window is now set. Use the Program button to set a No Water Window for another Program, or exit the dial position to save the settings.

### No Water Window rules

- Each Program may have a different No Water Window.
- If the operator attempts to program a Start Time that falls within a No Water Window, the display will flash a warning. If the warning is ignored, the Start Time will be saved, but will not run during the No Water Window.

If a start time has already been programmed, and the operator attempts to enter a No Water Window which overlaps the start time, the display will flash a warning.



- If a Program starts at a "legal" time, but runs past the beginning of a No Water Window, irrigation will be stopped (display will show "Suspend"). If the No Water Window ends and the program still has time left, the irrigation will resume where it should be for that time of day. Any irrigation that was suspended during the No Water Window will be missed. Likewise, if a start time has already been programmed and the operator attempts to enter in a No Water Window, and the start time falls within the No Water Window time period being set, the display will flash a warning as well.
- Programs that continue into a No Water Window because of Cycle & Soak settings, or because of Seasonal Adjust settings, will also be suspended. However, there will be no warning in the display when these changes are made at Cycle & Soak or Seasonal Adjust.
- In version 4 and later, an ATTENTION message will be displayed whenever a Non-Water Window violation causes watering to be missed, and the missed stations will be listed in the Station Log.



### DELAY BETWEEN STATIONS

Delay between Stations allows the operator to set an automatic delay between sequential stations by Program, from 1 second to 6 hours. The original purpose of Delay between Stations was to provide time for slow-closing valves to shut down before the next valve was started, and these delays are usually set in seconds. The Delay can also be used to allow time for a well or pump reservoir to refill before the next station begins.

In the ACC, Delay Between Stations can be set by Program, which can be very useful when only certain types of stations (large rotor zones, low flow drip) are grouped within a program.

Start in any other dial position, hold the Information button down, and turn the dial to Set Station Run Times. Release the Information button.

The display will now permit programming of Delay between Stations.



### To set a Delay

1. Use the Program button to select the Program for which the Delay is to be set.
2. Use the +/- keys to set the delay in h:mm:ss format. Use the left and right arrows to move through the hour, minutes, and seconds fields until the delay is set.



The Delay Between Stations for the Program is now set.



Use the Program button to set a select another Program, or exit the dial position to save the settings.

### **Delay Between Stations rules:**

- Delays occur equally between all stations in a Program.
- Delays do not occur before the first station, nor after the last station.
- Delays may cause a Program to run into a No Water Window, and no warning will be flashed. The No Water Window will still prevent any irrigation during the No Water Window times.
- The delay time is not included in the "Total Program Runtime" screen, or the "Total Station Runtime" screen.

### **P/MV STYLE (NORMALLY CLOSED/NORMALLY ON)**

The ACC controller is designed to work with Normally Closed master valves (MV). The P/MV Style setting allows you to reverse this operating feature for very specialized applications, by making Normally Closed valve "on" all the time, except when a station is running. Then the normally closed master valve will turn off and close.

This is not a normal irrigation setting but may be useful for some specialized applications. The ACC controller is NOT designed to operate with true Normally Open valves.

ACC's two Pump/Master Valve outputs (labeled on the master module terminals as P/M1 and P/M2) are preset to Normally Closed (NC), but either of them can be set to Normally Open (NO).

A Normally On P/M setting means the station output is always hot (providing 24 VAC) until an associated station is activated, at which time the P/M output turns off.

- Start in any other dial position, hold the Information button down, and turn the dial to Set Pump Operation. Release the Information button.

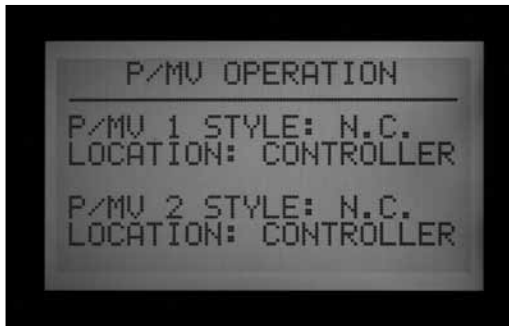

The display will now permit selection of P/MV1 and P/MV2 settings.

**To change the Normal condition of P/M outputs**

Use the +/- keys to set P/M1 to NC or NO. Use the right arrow to move to P/M2, and use +/- to change it between NC or NO.



The Location field is only changeable in Decoder controllers. In a decoder controller, the Location field may be changed from "Controller" to "ADM" (decoder module). If you select ADM as the Location, this indicates that the Pump or Master Valve is connected to a decoder that has been programmed to be the Pump or Master Valve decoder, and the decoder is connected to the two-wire path.

If a P/M output is set to NO, the green light on the Master Module for output activity is always lit, until a station with that P/M is activated. Then the station activity light will go out, to show the output has shut off.

**SETTING THE FLOW SENSOR SIZE AND TYPE**

ACC's Real Time Flow Monitoring is designed to work with Hunter HFS flow sensors. It is necessary to tell ACC what size fitting the HFS has been installed into, so that flow can be measured accurately for pipe size.

The ACC may also work with other standard types of flow sensors or meters available, but additional calibration is required. These sensors are set up under the selection "OTHER". One known compatible sensor is Data Industrial Model IR-220B (also sold as Hunter model GENDATFL), and other Data Industrial sensors with the same signal characteristics should perform satisfactorily.

The HFS must be installed into one of the mating FCT fittings designed for that purpose. At this time, there are 7 possible sizes ranging from 1" diameter (25 mm) to 4" (100 mm), in two different classes of pipe, according to the following table.

Pipe Size	Metric (rounded)	Class	Fitting Model	Minimum Flow (GPM/LPM)
1"	25mm	Schedule 40 (white)	FCT100	6/22
1.5"	38mm	Schedule 40 (white)	FCT150	13/49
1.5"	38mm	Schedule 80 (gray)	FCT158	13/49
2"	50mm	Schedule 40 (white)	FCT200	20/75
2"	50mm	Schedule 80 (gray)	FCT208	20/75
3"	76mm	Schedule 40 (white)	FCT300	50/189
3"	76mm	Schedule 80 (gray)	FCT308	50/189
4"	100mm	Schedule 80 (white)	FCT400	60/227

The HFS cannot read flow below the minimum rate (in GPM/LPM) listed for the pipe size.

After connecting the flow meter according to the HFS installation instructions, the Pipe Size must be entered into ACC for the measurements to be accurate.

1. To calibrate flow sensor readings: Start in any other dial position, hold the Information button down, and turn the dial to Set Flow Monitoring. Release the Information button to view the Flow Operation screen.

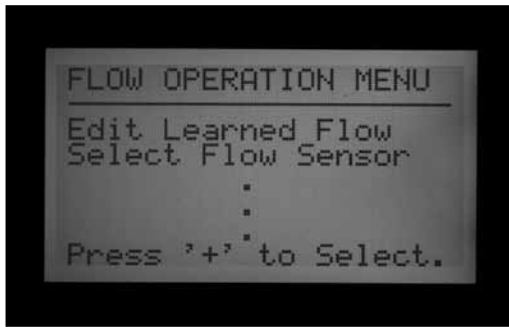

- Use the down arrow button to move to Select Flow Sensor, and press the + button to choose it.



- Use the + button to advance through the pipe sizes shown in the Fitting Model column until the correct size is displayed. The last selection after the standard FCT models is OTHER.



- If the controller has a decoder output module, and the flow meter will be connected to an ICD-SEN sensor decoder on the two-wire path, use the down arrow to move to Location. Change Location to ADM with the + or - buttons.



- Exit the dial position to save the settings, unless you have selected OTHER.

### Additional settings for OTHER

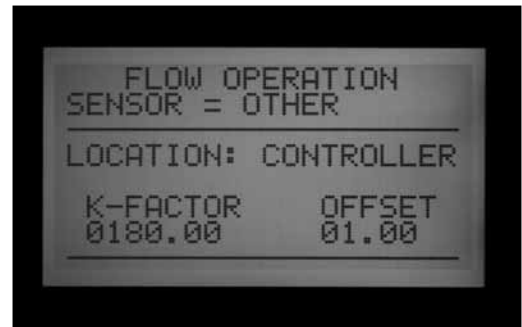

Most other brands of flow sensor require two settings for calibration, the K-factor and the Offset. The correct settings for these values are found in the sensor manufacturer's documentation, and they are based on the pipe type and size.

- Consult the "Other" flow sensor's documentation for the correct values for a given pipe size.
- If Other is chosen, use the down arrow to move to the K-factor setting.
- Use the right arrow to skip over any places that need to be left at "0".
- At any digit which needs to be changed, use the +/- buttons to enter the digit. Then move to the next place and repeat until the correct K-factor is displayed.
- Use the down arrow to move to the Offset value, and repeat.

When the correct values are shown for both K-factor and Offset, exit the dial position to save the settings. The flow sensor will now be calibrated for the pipe size.

### SSG (SIMULTANEOUS STATION GROUP) SETUP

Turn the dial to the Set Program Overlap Options position  
*See SETTING PROGRAM OVERLAP OPTIONS on page 36 for more information.*

SSGs are groups of 2, 3, or 4 stations which are grouped together electronically. They will then all run together and are programmed as a single unit. Up to 20 SSGs can be created in the ACC controller.

This powerful feature can be used to balance flow, shorten the water window, simplify programming, and expedite common tasks. SSGs can be included in automatic programs or custom manual programs, and can be started manually from controller at any time. They can also be named to make using them easier.

SSGs are not required to operate the ACC controller. They are a valuable extra feature for advanced users.

*See SSG Rules on page 49 for more information.*

To create and use SSGs: In order to create and use SSGs, the controller must first be placed into the SSG/Smartstack mode.



1. Turn the dial to the Set Program Overlap Options position.
2. Use the +/- buttons to select SSG/SmartStack.
3. Turn the dial to any other position to save the setting.
4. Hold down the Information button, and turn the dial back to the Set Program Overlap Options position.
5. Release the Information button, and the SSG Setup screen will appear.



6. The first possible SSG will be presented as STA GRP 01, and will display 4 rows (dashed lines in a new installation, station numbers if they have already been programmed). Each line is for a station that can become a member of the SSG.
7. Use the down arrow to go to the first dashed line (or existing station number).
8. Use the +/- buttons to select a station number. Once a station has been assigned to an SSG, it is no longer available for other SSGs, and will not appear as one of the choices while pressing + or - in other SSGs. Once a station has been programmed into an SSG, this station will no longer be available individually as a single station outside of the SSG. If a station in an SSG is viewed individually in the Station Run Times position, the run time will be filled with asterisks (\*\*:\*\*:\*\*) and the screen will show the SSG to which the station belongs, instead. No run time may be entered for an SSG station individually. If a station has an individual run time in a program, that station will not be able to be programmed into an SSG. While entering stations into an SSG, the stations that already have a programmed run time will be skipped over, and the only stations with no run time will be shown.



9. Use the down arrow to go to the next station line, to add another station to the SSG.
10. Include 2, 3, or 4 stations in the SSGs as needed. (It is possible to create an SSG of only 1 station, but this defeats the purpose of the SSG- single stations may be mixed in a program with SSGs, as long as they are not SSG members.)



11. When the SSG is complete, you can create another SSG without exiting the dial position.
12. Use the up arrow to move back to the STA GRP location.
13. Press +/- to select another STA GRP number.
14. Continue to add stations and create SSGs until all desired groups are created and populated.
15. Turn the dial to any other position to save. The SSG groups that you have programmed can be found within the "Set Station Run Times" position after the last station number in the controller, or by going backwards from station 1. The same is true for the "Manual Operation" dial position (the SSG groups will be found after the highest-numbered individual station).

You may run a station individually, even if it has been programmed in an SSG, by selecting the "One Station" manual in the Manual Operation dial position, and then selecting the specific station you would like to run. You may also run a station individually that has been programmed in an SSG by using a remote control.

### **EDIT AN SSG**

Changing or deleting an existing SSG is done from the same Extended Feature.



1. Hold down the Information button, and turn the dial back to the Set Program Overlap Options position.
2. Release the Information button to view the SSG Setup screen.
3. The first SSG will be displayed and highlighted. Change to a different SSG by pressing + or – to move through all SSGs.
4. When the SSG to be edited is selected, use the down arrow to move to the stations area of the display.
5. To replace a station in an SSG (with a different station): Highlight the station to be replaced. Press the + or – buttons to change the line to the new station number.
6. To delete a station in an SSG (without replacement): Highlight the station to be replaced, and use the + or – buttons until the dashed line appears. This choice appears between the highest numbered station, and the lowest station remaining which has not been assigned to an SSG. Leave the dashed line and move to a different field in the display with the arrow buttons.
7. To add a station to an SSG: Use the down arrow to move to the next blank dashed line.
8. Use the + or – to select the station to be added. Once all 4 lines are full (contain station numbers or names), the SSG is full and no more can be added.



### ADDING AN SSG

Enter the SSG Setup mode (Information + Set Program Overlap Options).

The first SSG will be highlighted.

Use the + button to advance through all existing SSGs, until the next unused SSG appears (having all dashed lines with no station selections), and select stations as desired.

Once the controller is in ACC Setup mode, all 20 SSGs are available, whether they are used or not.

### DELETING AN SSG

Technically SSGs are never deleted, as there are always 20 available. Instead, simply select the unwanted SSG, and delete the stations contained in it until no stations are listed under the SSG name.



### SSG FLOW DATA

SSGs use the combined learned flow data for all their member stations. They do not have a flow assigned directly to them. If the stations in an SSG are edited (added or deleted), the flow for the whole SSG will change by the amount of that station.

### SSG RULES

A station which is included in an SSG may still be started separately at the Manual Operation function or from the ICR remote control.

A station which is included in an SSG is not available for individual placement in automatic Programs, while the controller is in SSG/SmartStack mode.

In the Set Station Run Times position, individual stations which are SSG members will be shown, but their run times will show as \*\*:\*\*:\*\* and cannot be changed. The display will show the number of the SSG to which they belong, and the run time for the SSG should be changed instead.

SSGs are shown at the end of the station list when setting run times, and most other functions. For example, in a 12 station controller, the stations would be displayed as 1, 2, 3...12 followed by SSG 01, SSG 02, etc.

Beginning from station 01, use the – button to see the SSGs quickly (like going backward from the beginning of the list to the end of the list).



## CUSTOM MANUAL PROGRAM SETUP

Press the INFORMATION button and turn the dial to Manual Operation.



Custom Manual programs are “preset” irrigation sequences which do not run automatically, but can be started at any time from the Manual Operations position. The ACC permits up to 4 Custom Manual programs.

Custom Manual programs can be used for many specialized functions that are commonly started from the controller, to save tedious setup each time the function is needed. They also permit very flexible programming for unusual applications.

To create a Custom Manual program: Press the Information button, and turn the dial the Manual Operations position. The Custom Manual setup screen will appear.



The screen will show a setup form for Custom Manual Prg 01.

To set up a different Custom Manual, press the Programs button to advance.

To continue setting up the selected Custom Manual, press the down arrow to advance to the first Event.

Events can be stations, SSGs, or even Delays. Events are the order in which items will run.

Use the + or – button to choose a station or SSG for the first event.

Use the right arrow to move to the duration (time) for the event. This can be completely different from any run times that item may have in regular programs (A-F).

After run times are entered, the “Use Cycle and Soak?” question will appear, if the station or SSG has been

programmed to use Cycle and Soak with the “Y” selected. If you want the stations or SSGs to use their normal Cycle and Soak settings (if applicable), leave the option set to “Y.” If not, change the “Y” to “N” with the + or – buttons.

For specialized applications where longer run times are desired (such as leaching), leave the Use Cycle and Soak to N and the station or SSG's Cycle and Soak settings will be ignored.

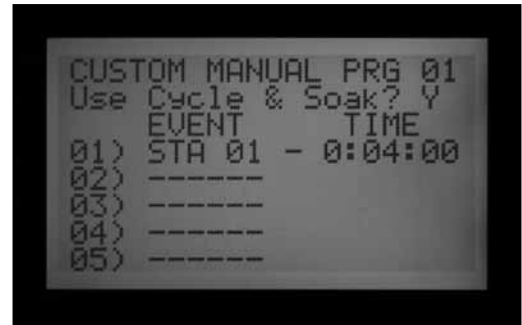

Use the down arrow to move to the next event, and continue until the Custom Manual program is complete.

## CUSTOM MANUAL RULES

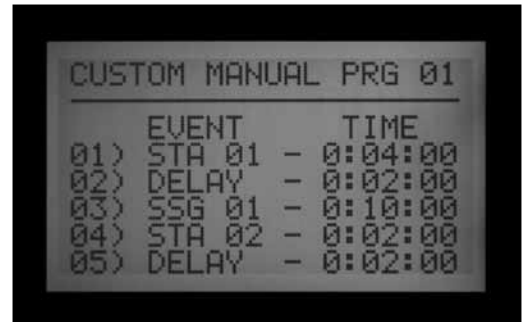

- Delays can be inserted as Events. Use the + or – buttons (the – button is often closer) to scroll through the stations and SSGs to DELAY (occurs below Station 01, and above the highest numbered station or SSG). Set a time for the delay as though it were a station.
- Stations and SSGs may be mixed in a Custom Manual.
- The same station (or SSG) may be included multiple times in a Custom Manual.
- Stations (or SSGs) may run in any order in Custom Manuals, unlike automatic programs.
- Custom Manuals are always run in an overlapping mode, because they are manually started.

For example, if an automatic program, manual, or ICR command is already running, the custom manual will run at the same time within the six station maximum rule. If there are already three stations running, and the first event in the Custom Manual is an SSG, the screen will explain in the Manual Operation dial position that it cannot run the Custom Manual because the max number of stations is already running.

## START A CUSTOM MANUAL

- Turn the dial to the Manual Operation position.
- Use the Program button to select the Custom Manual program (Custom Manual programs will appear after the A through F selections).
- Turn the dial to Run, to start the Program at the beginning. The display will show "To Manually Start Station 01...", but this only indicates that it will start at the beginning of the program. Each station will run for its programmed time, and stations with no run time in the selected program will be skipped.



- To start later in the Program (at a higher numbered station), use the down arrow to move to the station number, and press the +/- buttons to advance to the desired station (or SSG) number.
- Turn the dial back to Run to start the Program at the desired station. The Program will begin at that station and continue until the last event, then stop.

The display will show #-CUST under Mode, to show why the stations are running.

## TEST PROGRAM



Press and hold the Programs button

ACC has a quick Test program which will run all stations for a selectable period of time, in numerical order. The Test is an easy way to walk through every station in the system to verify proper operation, or perform diagnostics. It also features a quick advance for stepping through stations with the arrow button.

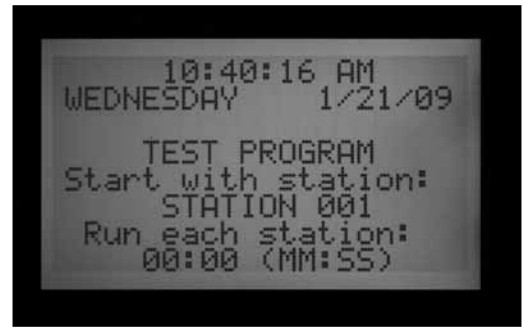

Test does not run SSGs or programs. It activates each individual station output in turn.

### Run a Test Program

- Turn the dial to the Run position.
- Press and hold in the Programs button for approximately 3 seconds.
- The Test Program screen will appear below the time/date display.
- The screen will show Station 01 (and its name, if applicable) and the run time field will be highlighted.
- To start the Test Program on a station higher than 01, use the Up and Down arrow buttons to advance the starting station number.
- Use the +/- buttons to set the test run time, in mm:ss format. The maximum run time in Test mode is 15 minutes. The minimum run time for Test is one second in conventional controllers and 15 seconds in decoder controllers.
- Use the right and left arrow buttons to move between the minutes and seconds fields to set the universal test time, and then wait a few seconds.
- The Test program will begin running in 3 seconds if no further buttons are pressed. Each station will show the time remaining in the display.
- Once the Test program is running, the stations can be advanced or reversed without waiting for the run times to complete. Press the right arrow button to step up one station immediately. Press the left arrow button to back up one station (this will restart the previous station with a new Test run time).

- The Test Program will try to start ALL stations counted by the controller. If you are running a Test Program on a decoder controller, the Test Program will attempt to activate all 99 stations. If you do not have 99 stations installed in the field, this may cause multiple alarms for decoder stations that are not present and do not respond.

### EASY RETRIEVE™ BACKUP

Press the INFORMATION and Programs button at the same time with the dial set at Run position).



This saves the complete controller setup, including programs, start times, run times, etc., in a safe part of the controller's memory.

Once this info is saved, it can be recalled and the controller can be restored to that condition regardless of what has been programmed or altered since.

Remember to save an Easy Retrieve backup after the controller is programmed and fully operational. If other people make unauthorized changes or don't know what has been done to the controller times, the Easy Retrieve restore function can be used to restore the controller to the original program set up.

- To save an Easy Retrieve backup: First, make sure the controller is in the desired state of programming, including Days to Water, Start Times, Run Times, names, etc.
- Turn the dial to the Run position.
- Press the Information and the Programs buttons at the same time.
- The Easy Retrieve save screen will appear.



SAVE will be highlighted. Press the + button to save the program, and a confirmation message will appear. The Save can still be cancelled with the – button, or press + to complete the save. The backup will be complete if + is pressed.



- To Restore an Easy Retrieve program: Turn the dial to the Run position.
- Press the Information and the Programs buttons at the same time, and the Easy Retrieve screen will appear.
- Use the down arrow button to move from Save to Restore.
- Press the + button to Restore. A confirmation message will appear.



- Press – to cancel the Restore, or + to continue with it.
- If + is pressed to confirm, the original saved Easy Retrieve program will replace the existing controller information.
- If you wish to make a new backup, leave Save highlighted and press + to create a new backup. This will completely replace the original Easy Retrieve backup with the new one.
- If no backup has ever been made, the Restore option will not be shown until an Easy Retrieve backup has first been saved.

## ONE TOUCH MANUAL START .....



One-Touch Manual Program Start with Station Advance (right arrow button)

With dial in Run, press and hold the right arrow button approximately 3 seconds to enter Manual Program start mode.

Choose desired program with Programs button, and wait.

Program will start in approximately 3 seconds, if no other buttons are touched. The controller will run the selected program until it is finished. Note that the program will still run automatically at the scheduled start time (if it is a watering day).

You have the option of beginning on a higher-numbered station or SSG, if you do not wish to run the whole program.

Before the program starts, use the down arrow button to move to the station number in the display.

Press the + button to move to a higher-numbered station or SSG, and wait approximately 3 seconds.

The program will begin on that number. It will not “circle around” and water the lower numbered stations. It will begin at the number you selected, continue to the end, and stop.

Once the Program is started, press the right arrow again to advance, to the next highest-numbered station (or SSG) in the Program with a run time. You may continue to

advance through all the stations/SSGs in a Program.

- If the controller is running that last (highest numbered) station or SSG with a run time in the selected program, and the right arrow button is pressed again, the station will be stopped and no new stations will be started (the program will have completed).
- The Station Advance feature does not work in reverse. You may advance, but you may not step back down through the lower numbered stations and SSGs.
- SSG groups are advanced as a group. If the SSG running contains 1, 2, and 3, and the advance button is pressed, 1, 2, and 3 are all stopped and replaced by the next station or SSG in the program. If the next item was an SSG containing 3, 4, and 5, then stations 1,2, and 3 will be replaced by stations 3, 4, and 5.
- You may start multiple programs with the One-Touch Manual Program Start. Start the first program and wait for it to begin. Then press and hold the right arrow again. Until you change programs, the display will show "CANNOT RUN MANUAL. This program is already running."



- Press the Programs button to select another program and wait about 3 seconds for the program to begin.
- Stack and Overlap settings are observed in Manual Starts. You may only run multiple programs manually if they are all set to Overlap.

## MANUAL OPERATION DIAL POSITION .....

This dial position enables immediate operation of either a single station (including P/MV1 or P/MV2), or an Automatic Program. It can also be used to start an SSG or a Custom Manual Program (if these optional items have been created).



- Turn the dial to the Manual Operation position.
- Use the +/- buttons to switch between Manual Program, or Manual One Station.



“Program” will allow an entire Program to be run immediately, and will also allow the Program to be started at any station (to run from that point to the end).

- Use the Program button to select the Program (Custom Manual programs will appear after the A through F selections).
- Turn the dial to Run, to start the Program at the beginning. The display will show “To Manually Start Station 01...”, but this only indicates that it will start at the beginning of the program. Each station will run for its programmed time (including Cycle and Soak settings), and stations with no run time in the selected program will be skipped.
- You may change the run time for the station selected by using the +/- buttons to set the desired run time in h:mm:ss format. Changing the run time in this screen will only affect the station that is currently being displayed; it will not change other station’s run times in the manual program. Changing the run time in the “Manual Operation” screen will not change the run time for that station in the “Set Station Run Times” screen, which applies to the programmed automatic run time for that station.
- To start later in the Program (at a higher numbered station), use the down arrow to move to the station number, and press the +/- buttons to advance to the desired station (or SSG) number.
- Turn the dial back to Run to start the Program at the desired station. The Program will begin at that station and continue until the last event, then stop.

Manually started Programs and Custom Manual programs do not run for multiple start times. Programs started at a higher station than their beginning station do not start over at the beginning; they run from the designated station and run to the end, then stop.

“Manual One Station” allows any individual station, SSG, or P/MV to be started.



- Use the +/- keys to select a station. Any SSGs will appear at the end of the station list.
- From the Station 01 position, the – button will go immediately to the highest numbered station, or the SSGs. The Manual One Station function is the only way to activate P/MV outputs by themselves, without an associated station. You can assign a run time from 1 second to 6 hours to either of the P/MV outputs for manual watering or other purposes.
- Use the left and right arrow buttons to move between the hours:minutes:seconds fields.
- Use the +/- buttons to set the desired run time in h:mm:ss format.
- Turn the dial to the RUN position, and observe the display. The station or SSG will begin irrigating within a few seconds.

The display will always show a list of items running, why they are running, and the remaining time for each item.



## SYSTEM OFF.....

To completely stop all irrigation, including any stations which are already running, turn the dial to the System Off position.

Within a few seconds a large OFF will appear in the display. Any stations which were running will be shut down, and no new automatic irrigation will be allowed to start.



The controller cannot run automatic programs with the dial in the Off position. However, ICR remote controls will still operate stations manually when the dial is in OFF.

## RAIN OFF.....

It is also possible to set a programmable period (from 1 to 31 days) for Off, after which the system will automatically return to automatic irrigation. This is useful for halting irrigation when weather fronts or conditions are expected to persist for several days.

To set a programmable Rain Off duration: turn the dial to the Off position.

While the controller is in the OFF mode, press the + button and hold for approximately 3 seconds.

The Days Left: xx display will appear. Release the + button, and then use the + or – button to set the desired number of Days Off before automatic irrigation will resume.



Turn the dial back to Run immediately (the days off setting will time out if it is left more than 5–6 seconds).

The display at the Run position will then show the number of days for the Off setting. This display will count down each day, showing the remaining days until automatic irrigation will resume.



## RESET.....

The ACC controller can be reset, erasing most programmed information. There are 5 different levels of Reset command available, but once any of them is chosen, the information will be permanently erased.



To Reset the ACC controller: Turn the dial to the Run position.

Press and hold the Programs button, and at the same time press in the recessed Reset button with the tip of a ballpoint pen. Release the Reset button and continue holding the Programs button until the Reset Memory screen appears (then release the Programs button).

### **These operations are not reversible!**

Reset should only be performed if:

- a “clean start” is desired for programming purposes, or
- if directed to do so by Hunter Technical Services as a troubleshooting technique.

The display will show the following Reset options:

- Programs: Erases Day schedules, start times, and run times.
- Flow Totals: Clears the running flow total histories (they will restart with 0.0 for all entries), only.
- Logs: Clears alarm, controller, and station logs, only.
- Names: Clears all user-programmed names, including Programs, Stations, and SSGs.
- All Data: Clears all of the above items, and controller returns to original out-of-the-box programming state.
- Use the up and down arrows to highlight the desired type of Reset .
- Press the + button to select it.
- A confirmation message will appear. If + is pressed again, the selection will be reset.

None of the reset functions will erase the Easy Retrieve ‘backup’, if one has been made.



## DECODER OPERATIONS (ACC99D VERSIONS) .....

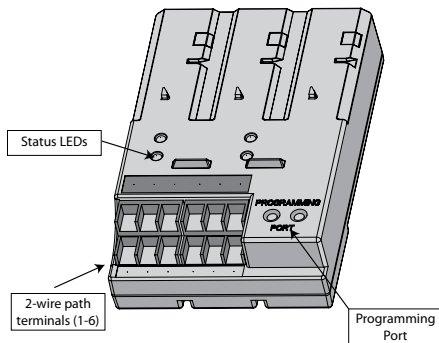

### CONNECTING THE 2-WIRE PATHS

1. Turn Controller power OFF.
2. If the decoder output module is a replacement for an existing decoder installation, simply reconnect the 2-wire paths to their screw terminal assignments. If more than one path has been used, attach the original red and blue pairs to the red and blue terminals with the appropriate number.
3. If this is a new installation, or conversion of a conventional controller to decoder operations:
  - Route the red and blue wire paths from the field up through the wire openings or conduit into the controller wiring compartment.
  - Connect the red and blue 2-wire paths to the decoder output screw terminals.
  - There are two rows of screw terminals on the decoder output module, one red and one blue, labeled 1-2-3-4-5-6. Each numbered pair represents a possible 2-wire path to the field (some systems only use one pair, others may use all 6).
  - Connect the red wire from a twisted pair to a

numbered red terminal, and connect the blue wire to the blue terminal with the same number. Do not connect more than one wire to any of the terminals. Do not mix red from one pair with the blue from another pair. Keep each pair separate, red to red and blue to blue, until all pairs are connected to their numbered terminals.

4. Turn controller power back ON and test. The Module/ Line Activity LED on the decoder output module should light up red for a few seconds. The red light should then disappear and the Line Status LED on the decoder output module should be a steady green, with no other line activity or stations running.

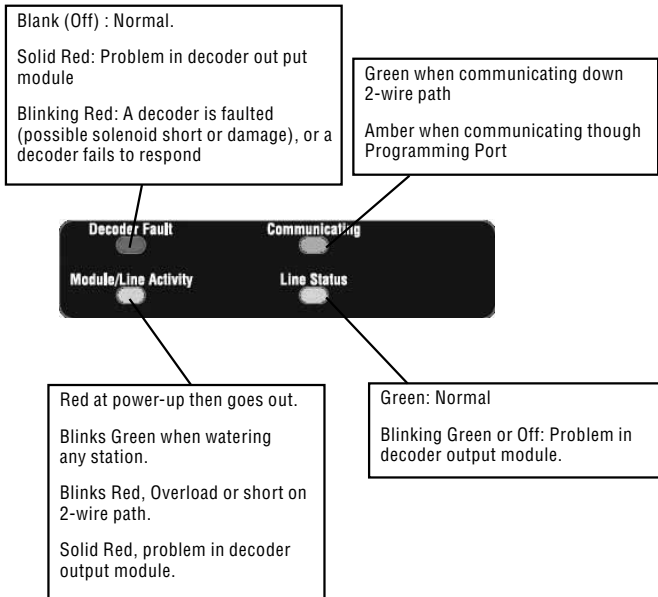

The decoder output module should now be completely installed and ready for normal operations.

### STATUS LIGHTS (ADM-99 OUTPUT MODULE)

The ADM-99 decoder output module has four status LEDs which can be helpful with setup and diagnostics. The replacement upper deck label is used to label these lights.

Place the decoder light label over the controller deck lid windows, not directly on the ADM99. The holes in the replacement label should allow lights to shine through. The decoder label aligns with station numbers 5, 2, 12, and 9.

### DECODER PROGRAMMING

Each decoder is programmed with station address(es) at the controller, before installing it in the 2-wire path. The decoder output module has two holes in the lower right called "Programming Port." Program the station number(s) into the decoders, and then write the station number assignments on the metallic tag on the decoders.

Before programming any stations, you should have an exact plan on paper for the location of each decoder and station in the system.

ICD decoders are available in 1, 2, 4, and 6-station sizes, and they may be mixed in the same system. However, the numbered station assignments for each decoder will be filled in automatically, depending on the size of the decoder.

**Do not program the same station number into two different decoders!**

When programming a 2, 4, or 6-station decoder, you only assign a station number to the first station output. The other stations are automatically filled in by the decoder in numerical order, depending on the decoder size.

For example, a 4-station decoder (ICD-400) will activate stations 20, 21, 22, and 23.

In programming, the decoder is assigned "20". Because it is a 4-station decoder, it will automatically fill in the other stations with 21, 22, and 23.

Single-station decoders (ICD-100) only receive the station number that is selected for them.



### PROGRAM DECODER STATIONS

1. Turn controller power ON.
2. Insert the stripped end of the red wire from a decoder into one of the two holes labeled Programming Port on the lower right of the decoder output module.

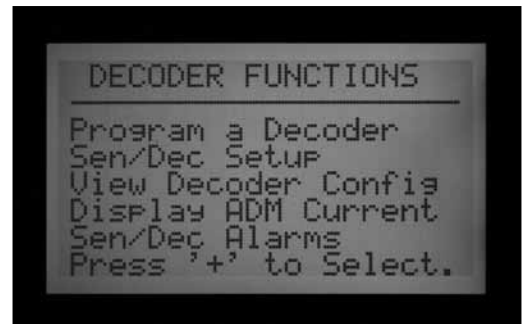

3. Insert the blue wire from the decoder into the other Programming Port hole. Do not let the wires touch each other!



4. Turn the controller dial to the hAdvanced Features position.



5. The display will show “DECODER FUNCTIONS,” at the bottom of the selections. Use the down arrow button to select Decoder Functions. Press the + button to select.
6. The Decoder Functions screen will appear, with “Program a Decoder” highlighted.

(The other functions are explained in detail in the Special Decoders Section). Press + to select. The display will then show “Checking for a decoder...” as it attempts to communicate with the decoder in the Programming Port. The Communicating LED on the output module will light amber when the programming port is in use (communicating with a decoder.)



7. The decoder output module will check for the presence of a decoder. If the wires are correctly inserted into the Programming Port, a screen will appear with the decoder settings.

8. If a decoder is recognized, the display will show current settings for the decoder. If the decoder is recognized as a station decoder, the size of the decoder (1, 2, 4 or 6) will show in the DEC TYPE area. Decoder type can be Station or Pump. Most decoders in most systems are type “Station”, which activate irrigation solenoids.

- Use the up and down arrow buttons to highlight different settings, and the + and – buttons to change them.
- Station number (When Dec Type is “Station”) can be any number from 001 to 099. **Do not allow more than one decoder in a system to have the same station number!**
- Power Factor is normally 2 and this is correct for most installations. Possible range is 1 to 5. In certain situations it may be necessary to change this value to hold in heavier solenoid loads. These values will change the duty cycle of the power supplied to the decoder from 10 to 38% in approximately 7% increments. **This value should not be adjusted unless absolutely necessary as it may adversely affect the performance of the rest of the system.**
- Inrush is normally set to 3 and this is correct for most installations. Possible range is 1 to 9. These values will change the timing of the initial powering of the solenoid from 0 to 90 mS in 10 mS increments to aid in activating solenoids and relays with higher inrush current requirements.



9. When the decoder settings are correct, push the Program button to send them to the decoder. The display will show “Programming...” for a few seconds until the information is downloaded into the decoder.

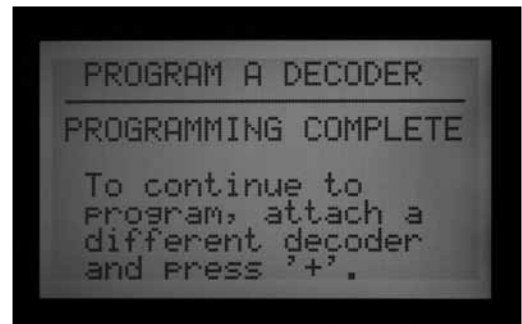

10. If the programming (of the decoder) is successful, the display will show “PROGRAMMING COMPLETE” and prompt for another decoder. Using a ball point pen, write the station numbers for each output of the decoder on the aluminum label for later reference. If the decoder has been accidentally disconnected or malfunctions, the display will show “Programming Failed!” This means the decoder was not programmed (check connection, and try again).

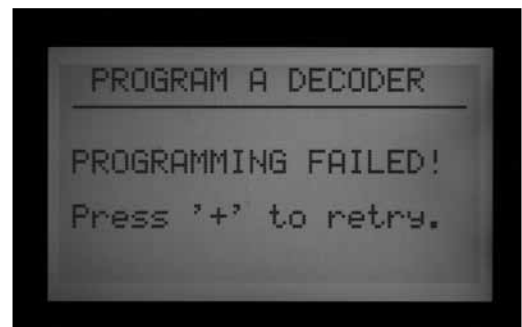

11. When all decoders and stations have been programmed, turn the dial to Run or any other position to continue working with the controller.

**Decoders may be reprogrammed at any time.** If it is necessary to change the station numbers or other settings of a previously programmed decoder, the decoder may be reconnected to the Programming Port. The old settings will be displayed at the “Program a Decoder” screen. Change the settings and press Program to download the new station numbers or settings into the decoder.

### DECODER PUMP/MASTER VALVES

Decoders can be assigned as either, or both, of the 2 possible Pump/Master Valve outputs per controller.

- Pump/Master Valve decoders should be ICD-100 single station decoders. If a multi-station decoder is assigned as a P/M, the other station outputs on that decoder are no longer available. It is possible to use the 200, 400, or 600 as a P/M output, but the other outputs will not function.
- The ACC or AGC controller only supports 2 Pump/Master Valve outputs, total, regardless of how they are connected. There are two “hardwired” output terminals on the controller’s Master Module (P/M1 and P/M2). Any combination of the Master Module terminals and the decoder stations is possible, but there can never be more than two P/M outputs, regardless of where they are connected.

To choose whether Pump/Master Valve outputs will be from the Controller or the Decoder, unlock the Extended Feature by holding down the Information button on the facepack, while turning the dial to the Set Pump Operation position.

Release the button, to see the P/MV Operation screen.

STYLE: “N.C.” means Normally Closed, which is the normal setting for most Master Valves (this works the same whether a Decoder is selected or not).

**It is not recommended to use the N.O. setting if the pump/master valve will be controller by a decoder.**

LOCATION: P/MV 1 and P/MV2 can each be set to either Controller (meaning the hardwired screw terminal position on the Master Module), or ADM, if a decoder output module has been recognized by the facepack.

- The ADM option is only shown if the ADM99 module has been installed and recognized by the controller.



“Controller” means the selected P/MV output will operate through the screw terminal with that number on the Master Module, in the controller.

“ADM” means that the selected P/MV will operate through one of the decoders instead.

- Use the Up and Down arrow buttons to move to the Location for the P/MV you wish to change.
- Use the + or – buttons to change the Location from Controller to ADM, for any Pump/Master Valve you want to reassign.

The ADM location will not work until a Decoder has been programmed for Pump operation (P/M1 or P/M2) in Decoder Programming.

The decoder programming for a pump or master valve is similar to programming a station decoder. Insert the red and blue wires into the programming port, turn the dial to Advanced Features and arrow down to Decoder Functions. Press the + button. While “Program a Decoder” is highlighted, press the + button. The display will then show current settings for the decoder.

- With the Decoder type highlighted, press + or – to change the Type from 1-Station to “PUMP.”
- The heading for the station number will change to P/MV. Select either 1 or 2 for the P/MV output. Do not allow more than one decoder in a system to have the same pump number!

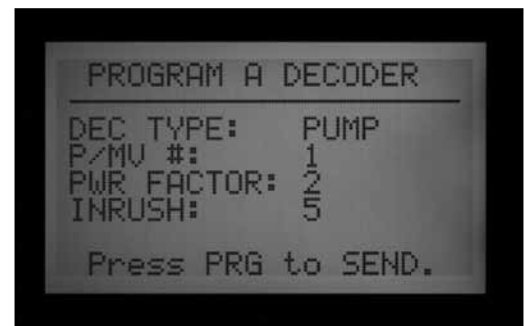

- Press the Program button to send the PMV address to the decoder.

This decoder will become the designated P/MV output for the controller.

### ICD-SEN SENSOR DECODER SETUP

The ICD-SEN sensor decoders accept input from sensors, and report them to the controller via the two-wire path. Each sensor decoder has two input “ports” (A and B) consisting of a looped wire.

To use a port, cut the wire and attach the sensor leads according to detailed instructions with the ICD-SEN.

Do not cut the wire on ports that will not be used.

Hunter HFS flow meters may only be connected to Port A. Clik sensors may be attached to either port.

When the flow meter is installed into the two-wire path, the ACC must be configured to read the sensor decoder. This will be explained in detail in the next section, Set Up Overview.



## SETUP OVERVIEW

### **Connect an HFS Meter to an ICD-SEN**

Hold the Information button, and turn dial to Set Flow Monitoring dial position.

Choose "Select Flow Sensor."

Change Location to ADM.



### **Connect a Clik Sensor to an ICD-SEN**

Hold the Information button, and turn dial to Set Sensor Operation dial position.

A separate screen will set Location for each Sensor (1 through 4).

At each Sensor input that will be attached to ICD-SEN, change Location to ADM.

Turn dial to Advanced Features, and select Decoder to begin programming a Sensor Decoder.

## SEN/DEC SETUP

Before continuing, determine whether the HFS or Clik Sensors are to be connected to a ICD-SEN on the two-wire

path, and that the location of the HFS or Clik Sensors are mapped to the ADM, described in the section titled, "Set Up Overview."

This creates the special sensor input assignments for the ICD-SEN sensor decoders. This step must be completed so that the controller and decoder will know which type of sensor is connected where.

- There can be up to five ICD-SEN sensor decoders in a decoder control system. They can receive addresses 1 through 5. This does NOT take away the station output addresses 1 through 5. Sensor decoders have their own type of address numbers, and the controller will know which "5" is a station, versus a sensor decoder.
- Each sensor decoder has 2 ports, A and B.
- A Hunter HFS Flow Sensor may be connected to Port A, only.
- Any "Clik" family sensor may be connected to either Port A, or Port B. It is also possible to have an HFS connected to Port A and a Clik sensor connected to Port B on the same sensor decoder.



- Turn the Dial to Advanced Features and use the arrow keys to move down to Decoder Functions.
- Press the + button.



- Move to SEN/DEC SETUP. Press the + button.
- This screen allows for the creation of the sensor input assignments for the ICD-SEN sensor decoders. This step must be completed so that the controller and decoder will know which type of sensor is connected where.

- If you are unable to enter an address or port for a sensor or flow meter, the Location for that device has probably not been set to “ADM.” Return to the previous section and check the Location settings.



- Use the arrow keys to move through the Flow and each Sensor input, to map the correct Decoder Address and Port. This step should be completed before actually programming the ICD-SEN.
- Example: Configuring an HFS, Mini-Clik, and a Freeze Sensor with two ICD-SEN sensor decoders. This example shows two ICD-SEN sensor decoders. One of the ICD-SEN sensor decoders is assigned address 1. This decoder in the field has the HFS wired to port A, and one of the Clik sensors to Port B. The second ICD-SEN sensor decoder is given address 2. This sensor decoder would then have the remaining sensor wired to Port A on the decoder.
- Once this screen is programmed correctly, you may begin programming the ICD-SEN sensor decoder in the programming port.
- Insert the stripped end of the red wire from an ICD-SEN decoder into one of the two holes labeled Programming Port on the lower right of the decoder output module.
- Insert the blue wire from the decoder into the other Programming Port hole. Do not let the red and blue wires touch each other!
- Turn the dial to the Advanced Features dial position. Arrow down to the Decoder Functions selection. Press the + button. With “Program a Decoder” highlighted, press the + button. The display will show “Checking for a Decoder...” as it attempts to communicate with the decoder in the Programming Port.



- The decoder output module will check for the presence of a decoder. If the wires are correctly

inserted into the Programming Port, a screen will appear with the decoder settings.

- If the decoder is recognized, the screen will display that it is a Decoder Type: Sensor. Select a Sensor Decoder address number from 1 through 5. These are not the same as station addresses, and do not cause a conflict with station output addresses 1 through 5.
- Address the ICD-SEN Sensor decoder to match the sensor input you want this decoder to communicate with. If the address is correct, press the program button to send the information.
- The screen will then display “Programming Complete”. If it displays the “Programming Failed” message, reinsert the ICD-SEN wires and resend the information.
- Once the Programming is complete, you may view which sensors the ICD-SEN sensor decoder has been mapped to, as well as the address.



- With the programmed ICD-SEN sensor decoder still in the programming port, use the Back button, or left arrow button, to go back to the Decoder Functions main screen. Press the + button with “Program a Decoder” highlighted.



- Once the decoder has been acknowledged in the programming port, press and hold the Blue Information button. The screen will display the decoder address, and the type of sensor that is connected to each of the decoder ports. Following is a display showing the previous example of two sensors connected to an ICD-SEN : The second ICD-SEN sensor decoder would appear like this:  
You may view the ICD-SEN sensor decoder information anytime after the decoder has been programmed in this manner. You may also change the

address or the sensor selections at anytime, if changes occur to the system.

- Turn the dial to “Set Sensor Operation.” There is a display page for each Program, allowing the responses for each sensor to be set. Select “Suspend”, “Pause”, or “Off” for each sensor.
- Note that a program may not have both Pause and Suspend responses. A program cannot be in both Pause and Suspend at the same time. The responses will automatically change to agree with the most recent selection. If you set S1 to Pause, and then set S2 to Suspend, the S1 will automatically change to Suspend. It is impossible for a program to be in Pause and Suspend at the same time.

- Once the sensor decoders are configured, the controller will immediately begin polling the sensor decoder continuously to monitor the alarms. This may cause alarm messages until the sensor decoders are actually installed in the two-wire path. The polling function can be stopped to prevent false alarms. *See Other Special Decoder Functions (Advanced Features) on page 62 for more information.*

## OTHER SPECIAL DECODER FUNCTIONS (ADVANCED FEATURES).....

### VIEW DECODER CONFIG

This allows the controller to search down the two-wire path and return the configuration of any installed decoder with an address. It can be used to determine whether a particular station belongs to a 1, 2, 4, or 6 station configuration, and can be used to retrieve the setup info for a specified Sensor Decoder.

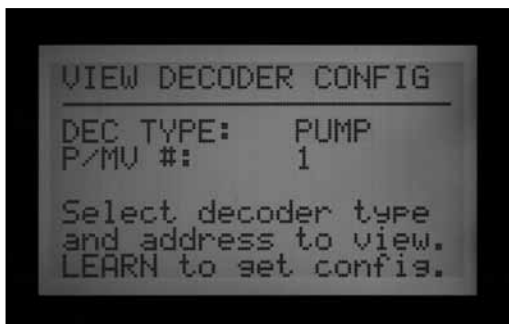

- Turn the Dial to Advanced Features. Arrow down to “Decoder Functions.” Press the + button.

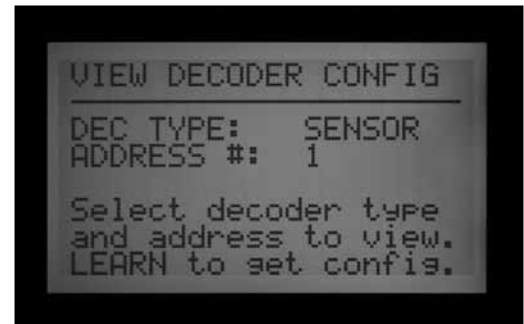

- Arrow down to “View Decoder Config.” Press the + button.



- This is a view-only screen and cannot be used to edit the decoder.

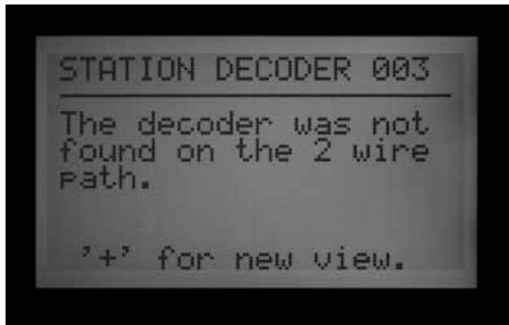

- Select the Decoder Type (Station, Pump, or Sensor), and enter the address.
- Press the Copy/Learn button to search for the decoder.
- If the address is found on the two-wire path, the configuration information will be displayed. If the decoder address is not found, it may not be present in the two-wire path, or may have a problem.

## DISPLAY ADM CURRENT



This shows the current draw in milliamps (mA) of all decoders connected to the decoder output module (ADM). It is used for diagnostic purposes.



- Turn the dial to Advanced Features. Arrow down to "Decoder Functions." Press the + button.
- Arrow down to "Display ADM Current." Press the + button.
- With no decoders connected, the reading will be fairly low, around 15 mA (there is no exactly correct value, but it should be in this range).
- Each decoder connected to a two-wire path will add

to the current draw, even when they are not running. Decoders require a tiny amount of current just to stay awake, about 5 mA.

- With a connected two-wire path, the mA reading in standby mode (no stations running) will vary depending on the number of decoders and other factors. The more decoders connected, the higher the standby reading.
- As stations are turned on, the current level will go up, about 20–40 mA per station.
- For diagnostic purposes, the relative increase in current is more important than the actual values. They can confirm that distant stations are working and can be used for other troubleshooting activities (such as isolating high current to a specific two-wire path, by disconnecting one at a time).
- The max value display is 2200 mA. This is informational only, and will not change. This is the overload point at which the decoder output module will shut down to protect from overcurrent damage.

## SEN/DEC ALARMS

This allows alarm polling down the two-wire path to be temporarily shut off, for diagnostic or installation purposes.

- Turn the dial to Advanced Features. Arrow down to "Decoder Functions." Press the + button.
- Arrow down to "SEN/DEC Alarms." Press the + button.
- When a Sensor input to the controller has been assigned to a sensor decoder, the controller immediately begins polling the sensor decoder continuously to monitor the alarms.
- If you have not yet installed the ICD-SEN, or wish to quiet the line for diagnostic purposes, you can turn this polling off. However, this also means that you will not receive any alarms from a sensor decoder, until the polling is turned back on.
- Turning the Sen/Dec Alarms to the OFF position will suspend polling, and start a 24 hour timer.



- When completing the installation or diagnostics, the Sen/Dec alarm should be set back to the ON setting.
- If you forget to turn polling back on, the controller will automatically reset polling to ON after 24 hours have elapsed.

# ACC SOLAR SYNC .....

ACC has the ability to work in standalone mode with the Solar-Sync Sensor. This requires facepack version 5.0 or later, and will also require a Solar-Sync compatible Master Module (version 5.0 or later).

ACC only requires the Solar-Sync sensor. It does not use the Solar-Sync Module. The Module functions are part of the new ACC facepack firmware.

Solar-Sync uses solar and temperature data from the sensor to change the Seasonal Adjust settings for each ACC program. You may choose which programs are adjusted by Solar Sync, and which are left alone.

YOU choose the base run times for the hottest time of the irrigation season.

ACC Solar-Sync adjusts those times for the actual conditions, as detected by the sensor.

Solar Sync adjusts every midnight, based on the last 3 days average ET (evapo-transpiration).

The Solar-Sync option does not interact with central systems and is designed for standalone operation of a single ACC controller. Do not connect multiple ACC controllers to a single Solar-Sync sensor.

## PREPARATION

### Facepack Version

The ACC facepack must be updated to version 5.0 or later. To check the Version number, turn the ACC dial to the Advanced Features dial position. Press and hold the Information button, and see the Revision number.

- Facepack updates may be obtained from the Resources section of the Hunter Industries web site ([www.hunterindustries.com](http://www.hunterindustries.com)).

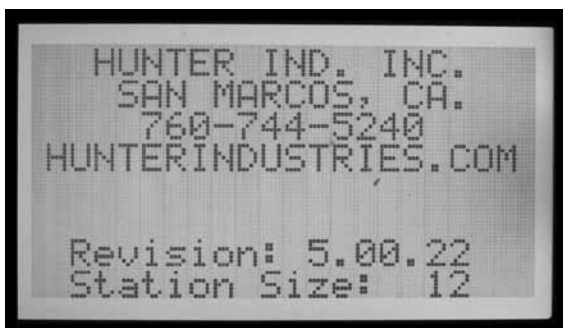

### Master Module

The Master Module (part 572000) must be version 5.0 or later to be Solar-Sync compatible.

- To check the master module version, turn the dial to the Advanced Features position. Select Utility Functions, then select View Firmware Versions. The master module version number will appear in the list of Module Versions found in the controller.

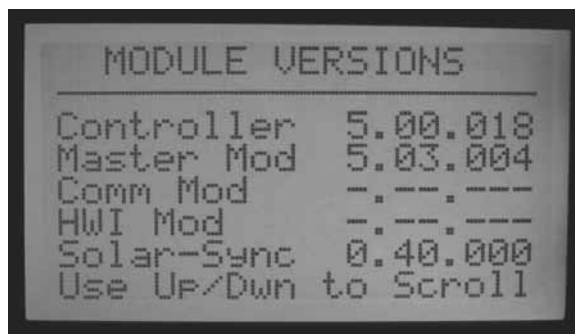

- Master Modules version 4 and later are “ET Ready”, meaning they will accept input from an ET Sensor for use within a central system. However, they must be updated to version 5 or later to operate with Solar-Sync.
- When new, a Master Module will ship with a Solar-Sync compatible sticker, if it is Solar-Sync ready.
- If the Master Module is not “ET Ready”, the value for ET will read, “Not Supported”.
- If the Master Module is “ET Ready” but the ET feature is not enabled, the value will read, “Not Used”.
- If either ET or Solar-Sync options are enabled, the correct sensor type will be shown.
- The Solar-Sync compatible master modules were not available before November, 2009.
- Master Modules cannot be updated in the field. Contact Hunter Technical Support if Solar-Sync is desired for use with an older ACC controller. The master module is easy to replace, and this will be required to update to the Solar-Sync version.
- Sensor version numbers will also be shown if the S-Sync option has been enabled, the sensor is installed, and communications has been established.

### Base Run Times

Program the ACC controller as specified in the Owners Manual for your controller. When setting station run times, enter the time that would normally be programmed during the peak summer watering season. The Solar-Sync is designed to adjust all run times daily based upon on-site weather conditions. This is done through the seasonal adjustment feature on your controller. It is recommended that all programming be conducted with the controller Seasonal Adjustment set at 100%.

## INSTALLATION

- Mount the Solar-Sync sensor according to the sensor instructions. The sensor must be within 200ft/60m of the controller, and must be installed outdoor in full sun.

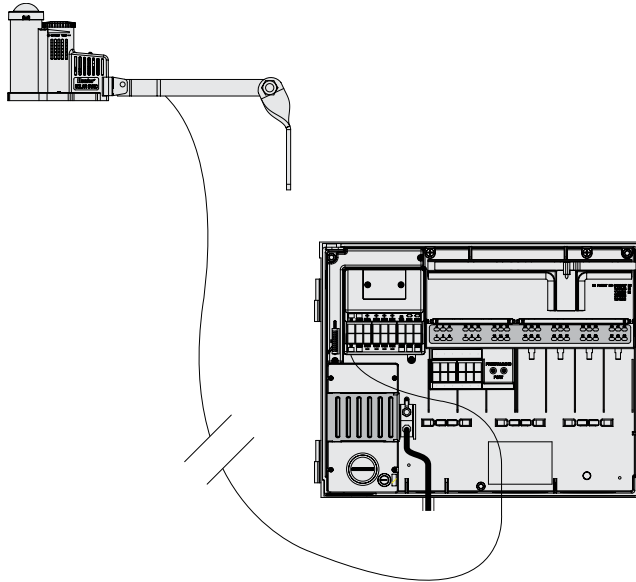

- The sensor should be allowed to receive the maximum sunlight possible at all times of day. Some locations may be shaded by trees or buildings during mornings or afternoons. Anticipate this when choosing the location. Maximum sunlight exposure during daylight is preferred.
- Route the wires into the controller cabinet through a low voltage conduit opening.
- Connect the wires according to color code to the ET terminals. The power and signals are DC, and the wires must be connected to + (Green) and - (Black) correctly. If the wires are reversed, the controller will not be able to receive signals from the sensor.
- All connections should be made inside the controller cabinet. If this is not possible, use waterproof connectors for any outside connections.

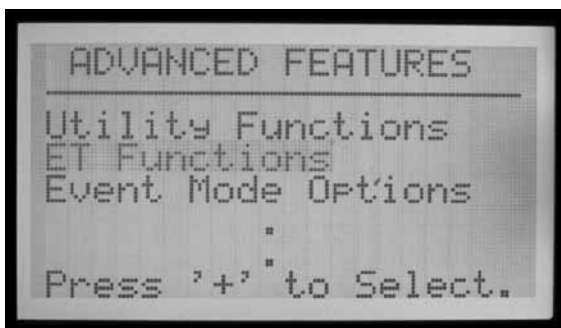

- The Solar-Sync sensor cannot be installed at the same time as a Hunter ET Sensor. Only one sensor can be connected to the ET terminals.

## SETUP

- When the installation is completed, turn the dial to the Advanced Features position. Select the ET Functions option (if ET Functions does not appear in the menu, the master module must be updated).
- Select the ET Operations option.

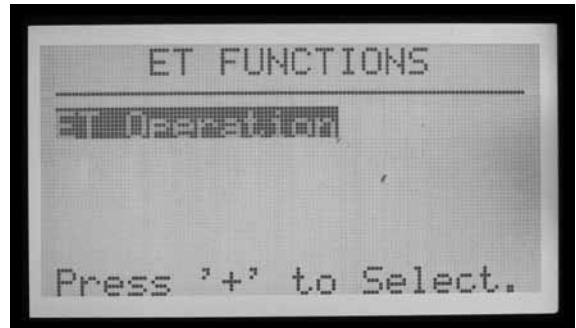

- The screen will display the ET Operation page. Set the Use ET option to "Yes" and the ET Mode to "SOLAR SYNC"
- Press the BACK button to return to the ET Functions menu.
- Select the Solar Sync Setup option.

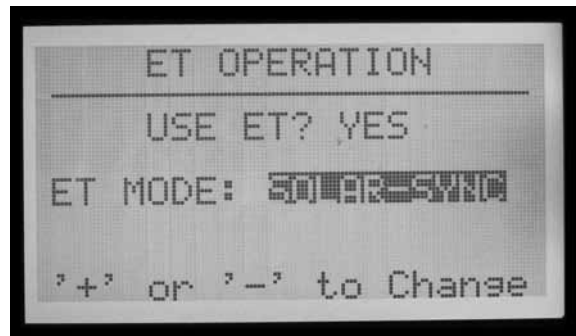

- The screen will display the Solar Sync setup page.
- The Solar-Sync Adjust value will show 100%\* until the first midnight (this cannot be changed).

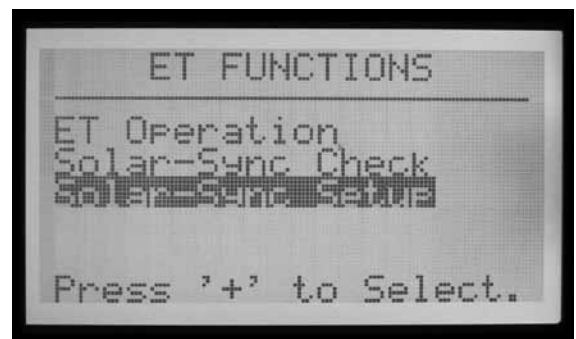

- At midnight, the Solar Sync Adjust will change to 80% or greater, based on the sensor. The asterisk disappears after a full 24 hours of sensor data has been collected.



- The settings will be set to Region 3, Water Adj. 5. Either of these factors can be changed, based on the following explanations.

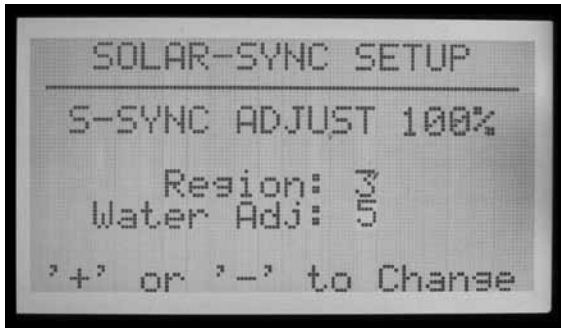

- Choose the Region that matches your location. Regions are defined by average ET in summer months.
- At each Regional Setting, the blue Information button on the ACC controller will also display help text for the type of Region.

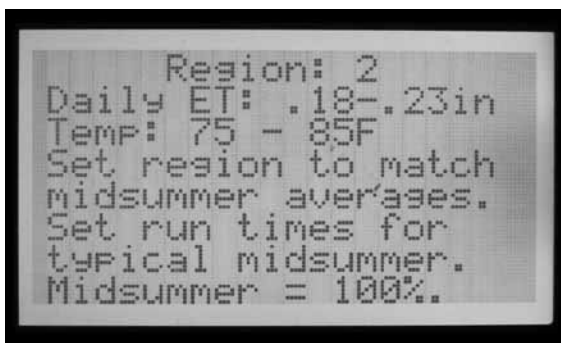

- The Water Adjustment factor is the ideal setting to adjust watering for your specific landscape. This setting can be from 1 to 10.
- If the Water Adjustment number is increased, the system will water more. If the number is decreased, the system will water less. This will allow you to find the best balance between healthy plants and water savings.

## SENSOR TEST

- When the sensor is installed, it is possible to test the connection to the Solar-Sync sensor.

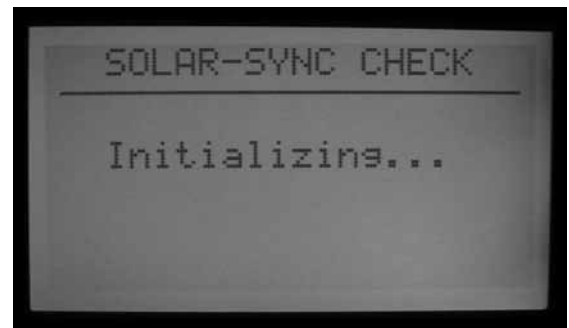

- Turn the dial to the Advanced Features dial position.
- Select ET Functions.



IF ANY OF THE CHOICES IN THE ROWS APPLY TO YOUR SITUATION, THEN THAT IS YOUR REGION SETTING CHOICE.

	A	B	C
<b>Region 1</b>	If the average July ET is <b>&lt; 0.17" (4.3 mm) per day</b>	If the average temperature for July is <b>65°-75° (18°C - 24°C)</b>	<ul style="list-style-type: none"> <li>• <b>U.S. Northern States</b></li> <li>• <b>Coastal Regions</b></li> </ul>
<b>Region 2</b>	If the average July ET is <b>0.18" - 0.23" (4.6 mm - 5.8 mm) per day</b>	If the average temperature for July is <b>75° - 85° (24°C - 29°C)</b>	<ul style="list-style-type: none"> <li>• <b>Mountains</b></li> <li>• <b>U.S. Northern Inland States</b></li> </ul>
<b>Region 3</b>	If the average July ET is <b>0.24" - 0.29" (6.1 mm - 7.4 mm) per day</b>	If the average temperature for July is <b>85° - 95° (29°C - 35°C)</b>	<ul style="list-style-type: none"> <li>• <b>U.S. Southern States</b></li> <li>• <b>Inland/High Desert</b></li> </ul>
<b>Region 4</b>	If the average July ET is <b>&gt; 0.30" (7.6 mm) per day</b>	If the average temperature for July is <b>95° - 105° (35°C - 41°C)</b>	<ul style="list-style-type: none"> <li>• <b>Deserts</b></li> </ul>

\* For Southern hemisphere locations, use the month of January.

- Select Solar Sync Check. The screen will show “Initializing...” for a few seconds as the controller contacts the sensor.
- If the check is successful, the screen will show “Sensor Check OK”. Continue with the Operation and Adjustment procedures if necessary.
- If the check is not successful, the screen will show “Sensor Check Failed”. Check sensor wiring and try again. Remember, the wiring is DC polarized and the wire from the green ET terminal in the ACC must be connected to the green wire lead from the Solar-Sync sensor.



### ASSIGN PROGRAMS

- Select which of the ACC programs are to be adjusted by Solar Sync. You may specify which of the 6 automatic programs will be adjusted. All programs set to Solar Sync will be adjusted by the same percentage, as determined by the Solar Sync.
- Programs which are not adjusted will continue with the same run times, and will not use the Solar Sync adjustment. They may be adjusted manually, however. This may be useful for specialized irrigation, or when programs are used to control non-irrigation devices.

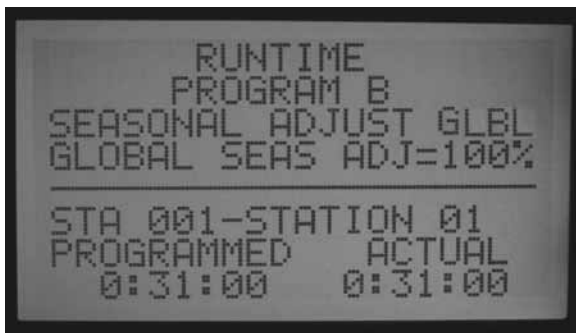

- Turn the ACC dial to the Set Station Run Times dial position.
- Press the RIGHT arrow button to move through all the run time fields, until the Seasonal Adjust selection is highlighted.

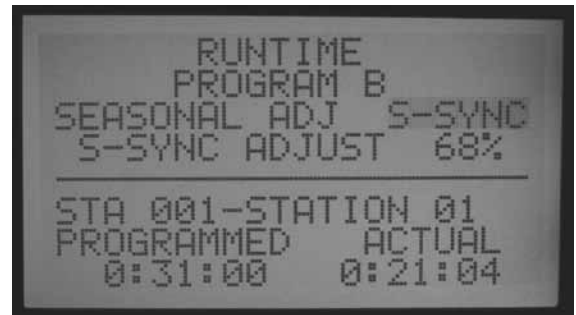

- Use the + and – buttons to change the Seasonal Adjust to “S-SYNC”. This setting is between 100% and 101%, immediately after GLBL (global). When Seasonal Adjust is set to S-SYNC, it will be adjusted automatically according to the Solar Sync sensor.
- Use the Programs button to move through each of the programs, and select S-SYNC for any program that you want Solar Sync to adjust.
- Programs for which you do NOT want Solar-Sync adjustment should be set to GLBL (they will stay at the Seasonal Adjust level set manually for the rest of the controller), or they may have individual Seasonal Adjustments by Program as described in the Seasonal Adjustment settings in basic controller operations.
- If the “S-SYNC” selection does not appear for a program (between 100% and 101%), the Solar Sync option has not been properly enabled for the controller. Review the Preparation and Setup procedures to troubleshoot.

### SENSOR SHUTDOWN PROGRAMMING

The Solar-Sync sensor can be used for sensor shutdown of watering at the controller. The Solar Sync can shut off irrigation automatically for Rain, or for freezing conditions.

In the ACC controller, sensors are programmed to shut down by individual program.

### SENSOR MAPPING

- After the Solar-Sync sensor is set up and operational, the built-in sensor inputs in the ACC controller can be “mapped” to use the Solar Sync sensor instead of other external sensors.



- Press and hold the Information button, while turning the ACC dial to the Set Sensor Operation position. Then, release the Information button.
- This will display the Sensor Configuration screen. This is used to tell the ACC which of its 4 sensor inputs will operate with the Solar Sync sensor.



- Choose the sensor input number with + or – buttons while the Sensor number is highlighted.
- Then, press the down arrow button to move to “Location”. Use the + or – buttons to select “SSync Rain” or “SSync Temp” to make that sensor input respond to the Solar Sync sensor.



- When either or both Rain and Temp have been assigned to Sensor numbers, turn the dial to another dial position to save the setup.

### SENSOR SHUTDOWN BY PROGRAM

- Turn the dial back to Set Sensor Operation (without holding the Information button).

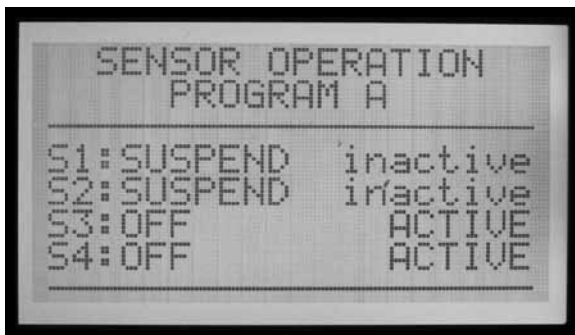

- The screen will display the sensor responses for Program A (unless another program has been selected). It will also display which sensors will shut down Program A.

- If the Sensors (S1, 2, 3, and 4) are set to Off, they will not shutdown the selected Program.
- Use the + or – buttons to change Off to Suspend, or Pause. See the sensor section in the ACC manual for a complete description of the difference between Suspend and Pause.
- Suspend is generally the better choice for irrigation programs! Make sure to fully understand Pause before selecting this option.
- If Sensor 1 (S1) is assigned to SSync Rain, change the response for S1 from Off to Suspend (with the + or – buttons), to have the program stop watering when the SSync Rain sensor is alarmed (active).
- If Sensor 2 (S2) is assigned to SSync Temp, change the response for S2 from Off to Suspend (with the + or – buttons), to have the program stop watering when the SSync Temp nears freezing.

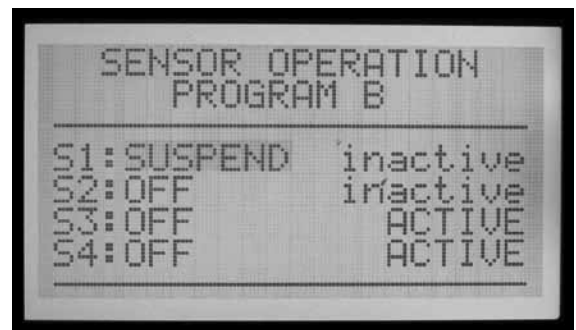

- Press the Programs button to move through each program, and configure the shutdown responses for the Solar Sync sensors, as desired.

### OPERATION & ADJUSTMENT

- Turn the dial to the Run position. The S-Sync Adjust status should appear in the display.
- When the system is newly installed, the S-Sync Adjust is set to 100% on the first day (this cannot be changed).
- At midnight, the S-Sync Adjust will change to 80% (or greater) based on the sensor.

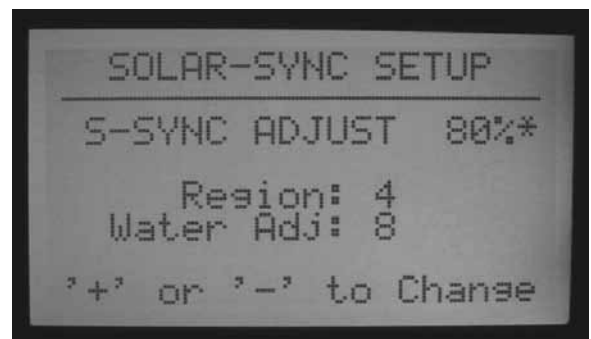

- The asterisk disappears from the Setup screen after a full 24 hour period of sensor data. The asterisk is not visible in the Run dial position display.

## MAKING ADJUSTMENTS

After programming the Solar Sync module and your controller, allow the system to operate for 3 days to gather sun and temperature data.

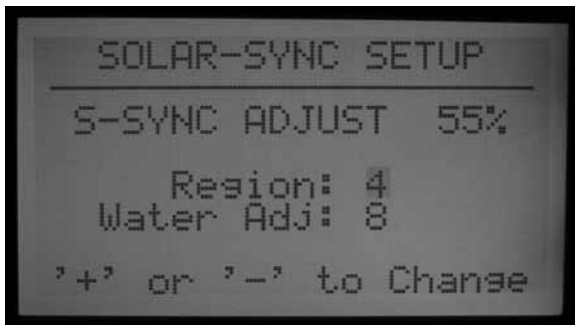

- Observe the S-Sync Adjust value on the controller display. If the amount seems to be lower or higher than expected for the time of year, use the Water Adjustment feature to correct.
- If necessary, the watering may be increased or decreased with the Water Adjustment factor. Only change the Region setting if you run out of adjustment range within your selected region. The Region setting adjusts sensitivity to weather change, and may have unexpected results.

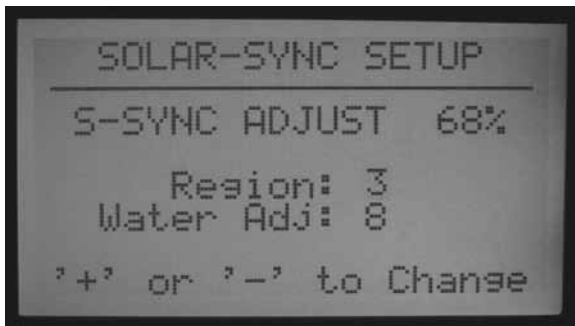

## INCREASE OR DECREASE WATERING

- Turn the dial to the Advanced Features dial position.
- Select ET Functions.
- Select Solar Sync Setup.
- Use the down arrow to select the Water Adj. setting, and use the + or – buttons to change the factor up or down.

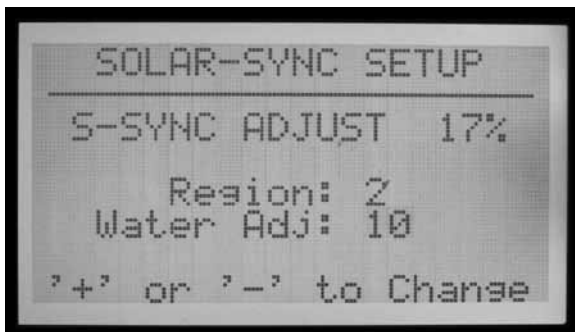

- Notice that as the Water Adjustment factor is changed, the current S-Sync Adjust amount at the top of the screen is changed. This can help you predict how much more or less watering will occur, as a result of the change (the actual minutes can also be seen at the Set Station Run Times dial position, after adjustment).
- When adjustment is complete, return the dial to the Run position.

## CHECK RUN TIMES

After adjusting the Water Adjustment factor, you can turn the dial to the Set Station Run Times to see the effects of the change, in minutes (or gallons or liters, if flow has been learned for the station).

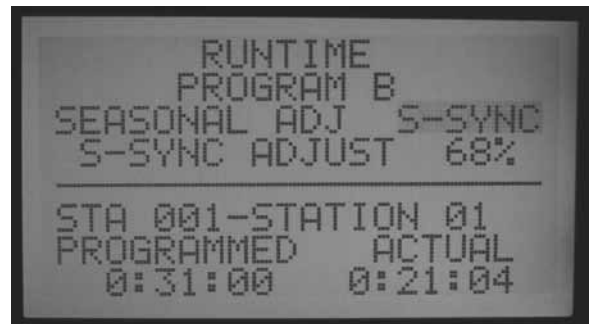

- Select a station in an adjusted program. The screen will show the “Programmed” run time, meaning the original run time, and “Actual”. The Actual run time is what will actually run with the effects of the Solar-Sync adjustment.
- If the controller has learned flow by station, press and hold the Information button, to view the estimated water usage (in gallons or liters) after the effects of the change.
- Run times occurring after midnight may be slightly different, since the next adjustment for today’s ET will occur at midnight.

**NOTE:** Set station run times for peak summer watering, with seasonal adjust set at 100%

## TRACKING THE ADJUSTMENT HISTORY (CONTROLLER LOG)

- It is possible to review the adjustments the controller has been making.
- Turn the dial to the Data History dial position.
- Use the arrow buttons to select the Controller Logs, and press the + button.
- The Controller Log displays significant events at the controller that are not alarms (alarms are tracked separately, in the Alarm Log). Every change to Seasonal Adjustment occurs approximately 2 seconds before midnight, and each change is recorded in the log.

- Use the – or + buttons to step backward and forward through the Controller Log to track the S-Sync changes. Each log will show the date and time, and the Before and After settings for Seasonal Adjustment.



- If the controller has been operating unattended for period of time, the performance of the Solar Sync adjustments can be verified in this manner.
- If a user changes the Solar Sync setup (either Region or Water Adjustment), this is also tracked in the Controller Log. It will also show the Before and After settings, but the log will show S-Sync Setup Changed At Controller. This means it was changed by a human operator.



- There may not be a Solar Sync log for each day! If the weather conditions are stable and the Solar Sync does not need to change, there will not be a log entry for the day. The logs are only created when Solar Sync makes a change to the Seasonal Adjustment settings.
- The Controller Log will store the most recent 250 controller events. The amount of other controller log activity will determine how many days of Solar Sync history are available.



## SOLAR-SYNC SENSOR ALARMS

S-Sync RAIN ALARM, S-Sync TEMP ALARM



- If the Solar-Sync sensors have been mapped to the Sensor 1-4 inputs on the controller, and one of the Solar-Sync sensors (Rain or Temp) detects an alarm condition, the display will show : ATTENTION S-Sync RAIN (or TEMP) ALARM



- This means that rain or near-freezing conditions have suspended irrigation (as set in the Set Sensor Operation dial position) until the alarm is cleared.

## S-SYNC COMM FAILURE

- If the Solar-Sync sensor fails to respond to the ACC controller, a Comm Failure message will be posted on the display and a log will be entered in the controller Alarm Log.



- This may indicate a problem with the wiring from the controller to the Solar Sync sensor. Use the Sensor Check function (Advanced Features dial position, ET Functions menu) to check current status of the sensor.
- Alarm Log records are created whenever an Attention message appears (Comm Fail and Restore, Rain and Temp Alarms and Alarm Clears). They are also created when an alarm condition is cleared. The Alarm Log can be helpful in tracking the duration of rain or freeze shutdowns, or communications failures with the sensor.
- Turn the dial to the Data History position, and select Alarm Log to view recent alarms. The most recent alarm is always shown first. Press the – button to step back through the alarm records, one at a time, up to the most recent 250 alarm records. Each record with have the date and time of the alarm event.



# IMMS-ET AND THE ACC CONTROLLER.....

IMMS-ET is central control software, designed to use a central computer to track the deficits, and schedule irrigation to replenish only the moisture that has been lost. The goal is to reduce or eliminate excess watering and grow healthier plants, without constant adjustment by the operator.

ET= Evapo-transpiration. This is a technique for determining how much moisture has been lost from the soil reservoir for each station (often "zone", or valve) of irrigation, based on climatic data. Natural rainfall may replenish some or all of this deficit. Automatic irrigation will provide the balance of the moisture required to keep plants healthy.

When ACC is in a computer central control system, it can be used to report ET from a Hunter ET Sensor to the central computer via IMMS control software. The computer can use the ET information to create ET-based run times for many controllers, including the original source controller.

- IMMS-ET requires a central computer and communications to function.

The ET Sensor does not adjust the ACC controller directly in standalone or offline use, even though you can see the daily ET displayed.

The computer must perform a full sync for the ET information to be retrieved, processed, and sent back to the controller(s).

ET Requirements:

- Master Module (part 572000) version 4.0 or higher (identified by green ET terminal, top left corner of module, AND the presence of the "ET Ready!" sticker). If the Master Module is an older version (with a red ET terminal, or a green one without ET Ready displayed), the ET functions will not be displayed until the module is updated. The first production release version of the ET Ready master module is version 4.22.010.
- ACC facepack version 4.0xx or higher.
- Hunter model ET Sensor. The sensor is connected directly to the ET terminals, with two 18 AWG/1mm direct burial wires, color-coded for polarity. Max distance from sensor to controller is 100" (33 m), and this distance should not be extended. Note that the ET Module (from Hunter ET System) is not used, with IMMS ET. The version number of the ET Sensor needs to be 1,50.000.

## ET SETUP AND OPERATIONS

Turn dial to Advanced Features dial position. If facepack and master module are updated to versions 4 or later, the ET Functions selection will appear in the menu selections.



## ET FUNCTIONS

The ET functions listed in Advanced Features only apply when an optional ET Sensor is connected.

After each ET function, it is possible to press the Back button (controller left arrow key) to return to the ET Functions menu and select another function.

While in the Advanced Features dial position, arrow down to "ET FUNCTIONS" and press the + button. If ET has not been enabled yet the screen will only give you the option of selecting ET OPERATION.

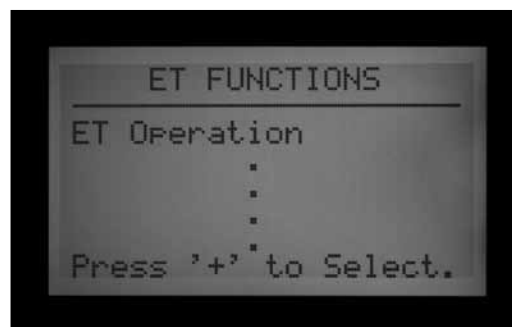

## ET OPERATION

Set to YES to enable ET operation. After turning the dial to Advanced Features and selecting ET FUNCTIONS, press the + button with ET OPERATION highlighted. The screen will then ask you if you want to USE ET SENSOR. If you have an ET Sensor and a central control IMMS system, press the + button and set to YES to enable ET operation.



This will cause the controller display to begin showing "Current ET: x.xx" in inches or millimeters, when the dial is turned back to the Run dial position. Also, with ET

Operation enabled, and set to YES, more ET FUNCTION options will be available and viewed in the ET FUNCTIONS home screen.

NO will hide all ET functions and the daily ET will not be read or displayed, and no ET will be available for the central computer.

Other ET functions will not be available if ET Operation is not set to YES. Enabling ET Operation is mandatory if you choose to utilize the ET Sensors for irrigation shutdown. If ET Operation is not programmed to YES, then the location of ET Rain, ET Temp, and ET Wind will not be available in the Extended Features of Set Sensor Operation, as a selection in mapping sensor locations.

### ET SENSOR CHECK

Turn the dial to Advanced Features and arrow down to ET FUNCTIONS. Press the + button. Arrow down to ET SENSOR CHECK, and press the + button to check the sensor, after the ET Sensor is connected. The controller will request an update from the sensor, and if a response



is received, will indicate OK. If the test fails (ET Sensor does not respond), check wiring to sensor, and try again. Note ET sensor connection is polarized (green terminal on the ACC master module must be connected to the green terminal on the ET Sensor, black terminal must connect to black terminal).



### VIEW ET SENSORS

Displays current readings from all individual sensors on the ET sensor platform. Turn the dial to Advanced Features and arrow down to ET FUNCTIONS. Press the + button. Arrow down to VIEW ET SENSORS, and press the + button. The display will show current readings from all individual sensors on the ET sensor platform.

ET, Rainfall, Wind speed, and Temperature will be displayed according to the Units of Measure setting at the Set Current Date/Time dial position.

Readings can be updated at any time, by performing a new ET Sensor Check first.

Solar: always displayed in Watts/m<sup>2</sup>, based on hourly average.

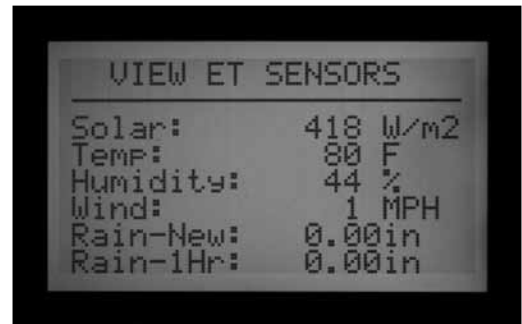

Temp: air temperature taken near top of each hour, displayed in Fahrenheit or Celcius.

Humidity: air humidity taken near top of each hour.

Wind: hourly average, in kilometers or miles per hour. If optional ET Wind is installed this will show actual wind at the location. Otherwise this value is set by the Automatic Prevailing Wind factor setting on the underside of the ET Sensor.

Rain-New: Rainfall in inches or millimeters since the last time the computer uploaded ET data.

Rain-1Hr: Rainfall in inches or millimeters within the last hour. The controller checks the sensor every 15 minutes, and two clicks of the rain gauge 0.02" (0.51 mm) within any 4 readings will create a rain alarm (if the ET Rain is configured as a Sensor input).

### ET ALARM SETUP

Individual ET sensors can be used to perform alarm shutdowns, by assigning them to the Sen 1-4 positions in the controller. The ET Sensors will then function exactly like "Clik" Sensor inputs. They may have Suspend or Pause responses set by Program.

Assigning ACC Sensor 1-4 alarm functions to an ET Sensor is done without connecting any additional wires. The controller will use the sensor data as a virtual alarm.

For ET Alarm setup, you will need to assign or "map" the ET sensors to the Sen 1-4 inputs, at the Set Sensor Operation dial position "extended features". The ET Alarm setup function sets the shutdown levels for these sensors, but they will not be effective until the mapping is completed.

Press and hold the Information button, turn the dial to Set Sensor Operation, and release the Information button. Arrow down to Location selections. If ET is enabled, there will be three possible selections to map to sensor locations: ET Rain, ET Temp, and ET Wind. Select and assign to specific sensor numbers as desired.



Turn the dial to another position, and then back to the Set Sensor Operation dial position (without holding Information). At this location, choose the Suspend or Pause responses for each ET Sensor by program

ET Sensor shutdowns only apply to the controller to which the ET Sensor is connected.

The ACC cannot shutdown other controllers as a result of these alarms.



ET Sensor shutdowns are not instantaneous, and there may be a delay of up to 18 minutes between an ET Sensor

alarm and the actual shutdown. If this is not acceptable, a separate sensor (such as Rain-Clik or Freeze-Clik) should be installed and wired directly to one of the Sen 1-4 inputs for instant shutdowns.

The controller will automatically check the ET Sensor for updated sensor readings every 15 minutes. If an ET sensor causes a controller Pause or Suspend, that action will remain in effect for at least 15 minutes until the controller updates the readings. If the sensor returns to normal, the Suspend or Pause settings will be cancelled, as with any other sensor.

Shutdown Levels. Turn the dial to Advanced Features and arrow down to ET Functions. Press the + button. Arrow down to ET Alarm Setup, and press the + button. The ET Alarm Setup function sets the shutdown levels for the sensors that are mapped as a location for sensor shutdowns.

Rain Max: The maximum amount of rain that will be permitted before a program is shutdown for the rest of the day. Move to this position with the arrow keys and use +/- to set the maximum.



The ET Rain sensor will shutdown sensors after 0.02" (0.51 mm) of rainfall within an hour (this amount is not programmable), but the program may be permitted to run again, if no more rain is detected. The ET Sensor checks for rainfall every 15 minutes.

If the Rain Max amount is reached, the controller will no longer attempt to run the program that day.

Temp: The air temperature can be used as a freeze sensor to stop automatic programs, and the temperature at which shutdown occurs is programmable (from 25° to 45° Fahrenheit, -3.8° to 7.2° Celcius). Move to this position with the arrow keys and use +/- to set the low temperature shutdown.

Wind: If the optional ET Wind is installed, the wind speed (in mph or kph) can be used to shut down designated programs.

Reminder: Alarm settings are not in effect until the Sensor 1-4 inputs have been assigned to them at the Set Sensor Operation dial position, and responses have been configured by program.

## EVENT MODE OPTIONS (AGC, SURVEYOR) .....

Event Mode is a special function of the controller designed to work with Surveyor Golf control software.

Event mode allows the controller to run individual station events which have been created for it by golf control software. These events may not be created or edited in the controller, and only special software can operate the controller in this mode.

**If you are not using Surveyor control software, you should never use the Event Mode options.**

The normal operating mode of the controller is called FCP mode ("Field Controller Programs"). This means the controller will use Programs A, B, C, D, E, and F normally.

If the controller is switched to Event mode, the A through F Programs will not run.

Change to Event Mode: This will switch the controller to the System Event mode (Surveyor Golf customers, only).



Turn the dial to Advanced Features. Press the + button. Arrow down to Event Mode Options. Press the + button. The first selection is Change to Event Mode.

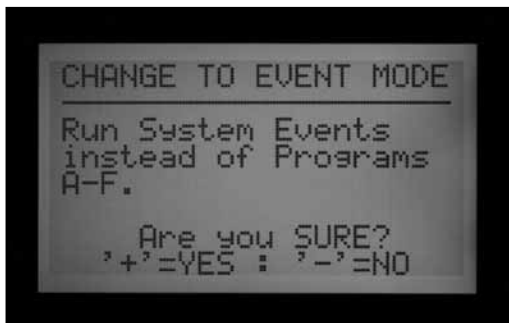

The display will advise that this will run System Events instead of programs A-F. If Event mode is selected, the display will always show System Event Mode On when the dial is in the Run position.



There is no special display when the controller is in the normal FCP mode... as long as System Event Mode On is not displayed at the Run position, the controller is in the conventional FCP mode.

The Event Mode Options screen allows the user to view three other selectable screens. While in the Event Mode Options screen, simply highlight the desired selection and press the + button. The three selections available are View System Events, Event Count, and Delete Events. These are only used in Surveyor Golf applications, to verify downloaded schedule information.

View System Events: This will allow you to view System Events for 1 to 3 days worth of downloaded System Events.

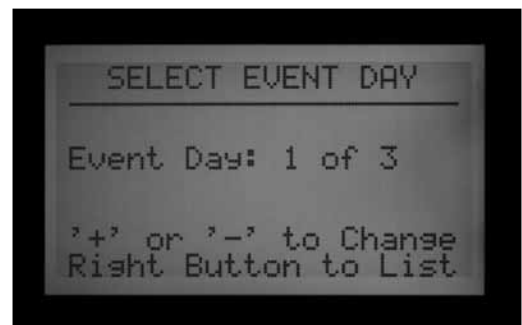

The AGC/ACC controllers are always either in Event mode, or FCP mode. The controllers can never be in both modes at once.

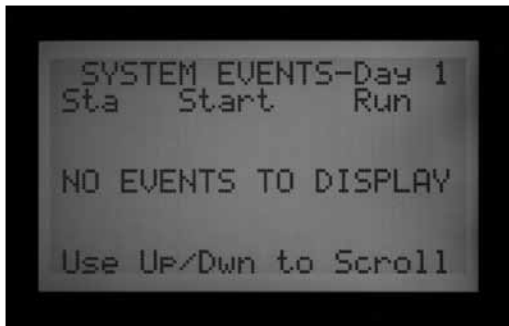

First, select the Event Day you wish to view (1, 2, or 3). Then press the right arrow button to view the downloaded events for that day. Use the down arrow to scroll through a large list of events.

Note: You cannot edit or change individual station events.



Event Count: This will show the total number of downloaded events. It is useful for verifying that an entire System Event download was received by the controller. The event count totals should match the total number of events in the Surveyor software.



Delete Events: This will permanently delete all downloaded System Events. The controller will not be able to irrigate until it has received a new System Event download, or until it is switched back to the FCP mode and FCP programs are created.

Types of Events: System Automatic Events are shown in displays as “SAE”. They are the individual station starts that have been scheduled by central software (Surveyor), and downloaded to the controller.

SAEs are the primary operating mode of Surveyor’s event-based irrigation scheduling. They may not be created or edited at the controller. They are only created when Surveyor applies flow processing to an event-type system program at the computer, and downloads the result to the controllers.

System Manual Events are displayed as “SME”. These are manual starts sent to the controller by an operator at the central computer. They are not part of the automatic irrigation but are started by Surveyor software when the controller is in Event Mode.

# CENTRAL SOFTWARE AND ACC-AGC COMMUNICATION MODULES ..

The ACC-COM-xxx module provides communications for ACC/AGC series controllers. It can be used to communicate with a remote computer via hardwire cable (ACC-COM-HWR), dial-up telephone (ACC-COM-POTS) or cellular phone (ACC-COM-GSM in North America, or – GSM-E for international). This module may be installed in wall mounted or pedestal mounted controllers.

## THEORY OF OPERATION

The Com module is a communications manager. It will contain the controller's unique identification (address), and enables communications into and out of the controller when combined with other devices. The Com module also coordinates communications between external devices and the ACC controller facepack.

The Com module may also communicate with other controllers, via optional RAD3 UHF radio modules (sold separately) with antenna for wireless communications, and/or an ACC-HWIM hardware interface module (sold separately) for hardwired communications over Hunter GCBL cable.

ACC-COM-POTS has dial-up communications ability built-in, but may also require the additional modules for outbound radio and/or hardwire connections with other controllers.

ACC-COM-GSM (-E) has cellular communications built-in, but requires a SIM card from the cellular provider, and may also require the additional ACC-HWIM and/or RAD3 modules for outbound radio and/or hardwire connections with other controllers.

Any Com module combined with a RAD3 radio installation will respond to Maintenance Radio commands from a UHF portable radio, equipped with a DTMF keypad.

Any Com module combined with a RAD3 radio installation will respond to Maintenance Radio commands from a UHF portable radio, equipped with a DTMF keypad. ACC Com modules have no effect on ICR (or SRR) remote control. The ICR and SRR remotes will work directly with ACC, whether a Com module is installed, or not.

The ACC-COM-POTS enables dial-up telephone communications via standard analog telephone line. It can also enable either UHF radio communications, or hardwired cable communications, or both. The hardwire and radio options require other components to work. Each communications option has different physical requirements.

Dial-up Telephone: Plan ahead for routing a telephone line into the controller. ACC-COM-POTS accepts a standard 4-wire RJ-11 telephone jack, but should be located within

6 ft./2m of the telephone outlet. Many trouble calls are caused by exceeding the telephone wiring distance, and routing telephone wires near electrically noisy equipment (electric motors, fluorescent lighting, etc.). Dial-up installations must be located as close to the telephone connection as possible. All outdoor runs of telephone line connections should be installed in metal conduit to reduce interference.

Once an ACC controller is connected via telephone, it can share the communications connection with other controllers via radio and hardwire. The following considerations apply to these optional outbound connections.

## UHF RADIO

The Communication Module ACC-COM-HWR, ACC-COM-POTS, or the ACC-COM-GSM (E) does not contain a radio. It is designed for use with a Hunter RAD3 UHF radio, which must be ordered separately.

The RAD3 radio will require an antenna, which is also sold separately.

In steel enclosures, the antenna must be installed externally (signals will not communicate from inside a metal box).

- Plan ahead for mounting an external antenna. It will be necessary to route the antenna cable from the radio module inside the enclosure, to the antenna outside of the enclosure. A site survey with comparable radios is required before a final decision can be made about antenna types and placement.

In the plastic pedestal enclosure, the Hunter IMMS ANT 2 antenna is designed to be mounted in the pedestal lid and may be adequate for communications (to be determined in advance by site survey).

In North America and most other countries, a license is required before operating any radio transmission equipment. Verify your local regulations and make sure that you have obtained the proper licensing before operating radio equipment.

## HARDWIRED CABLE

The Communication Module ACC-COM-HWR, ACC-COM-POTS, or the ACC-COM-GSM (E) does not contain a hardwire connection terminal.

Any controller needing hardwired communications must be equipped with an ACC-HWIM, in addition to the ACC-COM-xxx communications module. The HWIM is installed in the controller cabinet, on the ACC Master Module (see ACC-HWIM instructions).

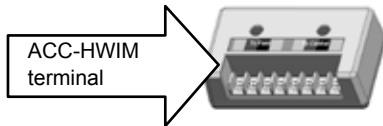

Hardwired communications also requires Hunter GCBL

cable. This special cable uses 4 color-coded twisted conductors, shielded with foil, and grounded with an additional bare wire, in direct burial jacket. The cable is also ordered separately.

- Plan ahead for routing the hardwired cable. The cable must be routed from the ACC-HWIM terminal, out of the enclosure, to any devices to which it will be connected.

Turn the controller AC power OFF before installing the Com module. You can turn off the AC power circuit to the controller, or remove the fuse at the controller transformer assembly. Pedestal mounted controllers have a power switch, which can be pressed to the OFF position.

- Note that there are additional steps listed for installation with RAD3 radio modules.

## COMMUNICATION MODULE INSTALLATION FOR WALL MOUNT CONTROLLER

1. Turn controller AC power off.
2. Open the facepack door frame and locate the communications compartment cover on the back right side of the frame. You may find it easier to complete the following steps if the facepack door frame is completely removed from the controller (disconnect facepack door frame ribbon cable, open and lift up the door frame to compress top hinge, and tilt out of lower frame).
3. Remove the communications compartment cover (6 screws).
4. Remove the ACC logo cover (two screws).

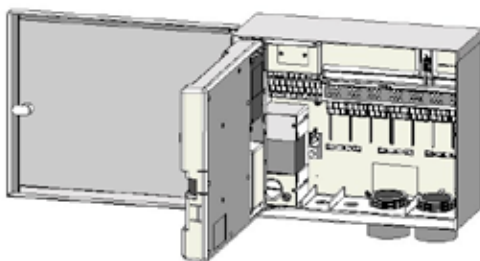

9-pin connector on the other end for connection to the radio. The 14-pin connector only plugs one way, and is keyed to assist proper orientation. Align the connector and push into place on the top of the Com module.

- When the Com module is installed in the opening, make sure that the ribbon cable is visible on the back of the unit, for connection to the RAD3 radio module.
5. If using the ACC-COM-POTS communications module, route the RJ-11 compartment via the low voltage conduit openings. Connect the telephone cable to the mating receptacle on the bottom of the ACC-COM-POTS modem, and insert until it clicks positively into place.

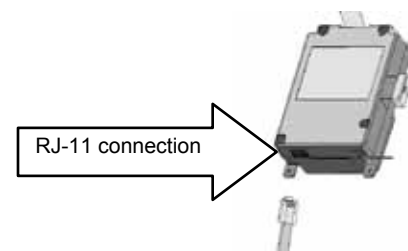

## RADIO INSTALLATION, ADDITIONAL STEPS

If the Com module will be used with a RAD3 radio, the radio ribbon cable should be connected now, before installing the ACC-COM-xxx into its compartment.

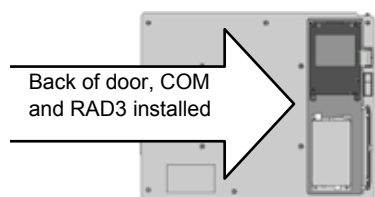

- The radio ribbon cable has a rectangular 14-pin connector on one end for the Com module, and a DB-9

If using the ACC-COM-HWR or ACC-COM-GSM (E) communications module, no additional steps or connections need to be made. Continue on with the following steps.

6. Route the radio antenna cable (if applicable) through the recessed track next to the radio compartment, and then through the low voltage conduit openings in the cabinet, for connection to external antenna.
7. Leave sufficient slack in the telephone and antenna cables to allow the door to open and close without crimping.

8. Insert the ACC-COM module into the opening where the logo cover was, with the display and buttons protruding through the opening. Secure with 4 screws (supplied) on each corner. The screws are recessed and a small magnetic tip screwdriver is very helpful for this task.
9. Carefully insert the modular ribbon connector plug into the mating receptacle in the door frame. This connector is keyed and has slots which must be aligned correctly, so that the connector can only fit one way. Press firmly to make sure that the connector is fully seated.

### **RADIO CONNECTIONS, ADDITIONAL STEPS**

- Before installing the RAD3 radio module, connect the DB-9 connector from the ribbon cable to the top of the RAD3 radio and secure with the connector screws (do not overtighten).
- Connect the radio power cable from the RAD3 radio to the radio power connection on the bottom of the Com module.
- Connect the male BNC radio antenna connector to

the RAD3, before installing the radio into the radio compartment.

- Install the radio into the radio compartment (see RAD3 installation instructions for additional information).

Reapply controller power and verify that the Com module display lights up and displays characters.

If there is no display:

1. Double check ribbon cable connection from Com module to facepack door frame receptacle.
2. Double check ribbon cable from facepack door frame to controller cabinet.

## **COMMUNICATION MODULE INSTALLATION FOR PLASTIC PEDESTAL CONTROLLER .....**

(requires APPBRKT communications bracket, sold separately)

1. Turn controller AC power off with the AC power switch in the pedestal.
2. Open the facepack frame in the top of the pedestal, to expose the communications module mounting area.
3. Install the APPBRKT communications bracket with its supplied mounting hardware. This bracket is designed to hold the Com module and a RAD3 radio module (if radio is required).
4. Install the ACC-COM-xxx into the APPBRKT mounting bracket. Secure the Com module with screws on each of the 4 corners.

insure that there is only enough slack to allow the lid to open and close, without causing the cable to be pinched.

5. Connect the ACC-COM-xxx ribbon cable extension to the controller facepack connection on the underside of the facepack frame. This is the keyed 14-pin connector, top left, above the main facepack ribbon connection.
6. When using the ACC-COM-POTS connect the RJ-11 telephone cable to the telephone service mating receptacle. In high lightning environments, the telephone cable may be connected through a grounded surge suppression device (some computer power strips have these built in).
7. Reapply controller power and verify that all devices power up and have displays. Proceed to Setup and Addressing of the Com module, in the next section.

### **RADIO INSTALLATION, ADDITIONAL STEPS**

- If radio communications will be used, connect the RAD3 radio module cables to the Com module with its ribbon cable and power connector first.
- Install the Com module into the bracket, and then install the RAD3 on the APPBRKT with supplied hardware.
- Install IMMS-ANT-2 in pedestal lid.
- Route antenna cable from the IMMS-ANT-2 through the slot in the metal frame for the facepack, down into the controller to the radio location.
- Connect the cable connector to the radio module (be sure to turn the BNC connector until it locks into place).
- Install the plastic cable guide (P-) with self tapping screw as shown. Adjust cable before tightening to

## SETUP AND ADDRESSING THE COM MODULE .....

When powered up, the Com module display will show the version number, and will automatically check to see what other communications devices are installed. This will take a few seconds, and the display will show the type of COM Module installed, ACC-COM-xxx when complete.

Note the version number and include it whenever seeking technical assistance from Hunter Industries via phone or email.

The Com module controls use the up and down arrow buttons to make selections, a + and – button to change individual settings, and an Enter key (far right), also identified as the Backwards Arrow Button. ←

Set Controller ID: The controller ID, or address, is required before any communications can take place. An address may be any number between 1 and 999.

### SET THE CONTROLLER ADDRESS

Press the Up arrow once. The display will show Controller Address. The Address will be 0 if the module is new.

Press Enter to enter the Address edit mode. Blinking boxes will appear over the controller Address number.

Use the + or – buttons to change the Address to the desired setting. If you hold the + or – button for more than a second, the numbers will change faster, in increments of

10. When you are close to the Address number you want to set, release and press again to fine tune the address to the precise number. You can go forward or backward with the + and – buttons to set the exact number.

Press the Enter button to enter the Address. The controller will now be addressed.

The controller Address is assigned to a Com module, not to the controller itself, nor to the ACC facepack. The controller Address can be reprogrammed at any time with the buttons, but it is important to remember that the facepack of the ACC controller does not have an address of its own. If you move an ACC facepack to another controller, the address remains with the Com module unless changed.

If you move a Com module with an Address number to another controller without readdressing, it will receive information meant for the first controller! The Addresses cannot be changed remotely (from the computer) and can only be set and changed at the Com module itself.

### OTHER COM SETUP FUNCTIONS

ACC-COM-xxx detects other communications connections and displays information about them. It also allows operator control of some settings and functions.

Use the Up or Down arrow to navigate through main topics.

“0” is the setting in a new, unadjusted Com module, which can be changed after installation.

### MASTER CONTROLLER

Shows YES if the controller has been designated as a Master Controller or NO if the controller has not been designated as a Master Controller. Press Enter to change, + or - to change, and Enter when done. The Master Controller designation is reserved for the first controller receiving communications with central for the Site.

Assigning a controller as a Master Controller or not as a Master Controller will have no effect on communications. It is reserved for future use.

### CONTRAST

Default = 50. Adjusts display visibility for varying conditions. Press Enter to adjust, + or – to change, and press Enter when done. The display contrast may be adjusted for daylight conditions where reflection makes the display difficult to read.

### RADIO TYPE

Shows a type of radio module, if one is found by the Com module.

Radio communications can be used in 2 distinct ways:

- To connect a controller to additional controllers within the same Site.
- To use a UHF Maintenance Radio (Hunter Model TRNR) as a remote control for the controller.

### LAST MR CMD (RADIO ONLY)

Displays the characters in the last-received UHF Maintenance Radio command, for diagnostic purposes. This setting is not shown if there is no radio. This setting only applies to UHF Maintenance Radio and will not show ICR remote commands.

### DTMF WAIT (RADIO ONLY)

Sets amount of time allowed between characters in a Maintenance Radio command, 1 – 5 seconds. The purpose of this setting (default = 2 seconds) is to tell the Com module how long to wait after hearing DTMF Maintenance Radio commands, before assuming the command is complete.

Maintenance Radio commands are sent from a UHF portable radio by pressing buttons which send DTMF (Dual Tone Multi-Frequency, also known as Touch-Tones) tones to the Com module. When a command has been started, the Com module assumes it is finished when the DTMF

wait period has elapsed or the radio carrier signal stops, with no more tones.

A longer DTMF wait allows slower typing speeds of the command on the radio. The trade-off is that the longer wait means that it will take longer for the action to be carried out (in other words, if the Wait is 5 seconds, it will be 5 full seconds after the command has been sent before the sprinkler turns on).

This setting is not shown if there is no radio. This setting does not affect ICR remote commands.

### **MR DEFAULT RUN TIME (RADIO ONLY)**

Default = 30 Minutes. This sets the automatic run time for any station or SSG that is started by a Maintenance Radio command, if no run time has been specified in the On command. It is possible to turn a station or SSG on without specifying a run time, and this setting will automatically turn them off after the specified time if they are not turned off by an Off command. The Default Run Time can be changed in 1 minute increments up to a maximum of 60 minutes. This setting is not shown if there is no radio and does not affect ICR remote commands.

### **MODEM TYPE**

Indicates presence of a telephone modem in the Com module. This display is informational and cannot be changed from the Com module.

### **COUNTRY CODE**

If a telephone modem is detected, the country code may need to be changed to work with regional data modem requirements. The default setting is "0" and for most countries this is the correct selection.

If your country appears on the following list, change the code display to the number shown:

<b>Country</b>	<b>Code</b>
<i>Australia</i>	<i>2</i>
<i>Czech Republic</i>	<i>3</i>
<i>Hong Kong</i>	<i>1</i>
<i>Hungary</i>	<i>1</i>
<i>India</i>	<i>1</i>
<i>Indonesia</i>	<i>1</i>
<i>Israel</i>	<i>1</i>
<i>Japan</i>	<i>4</i>
<i>North Korea</i>	<i>1</i>
<i>Malaysia</i>	<i>1</i>
<i>New Zealand</i>	<i>5</i>
<i>Philippines</i>	<i>1</i>
<i>Poland</i>	<i>1</i>
<i>Singapore</i>	<i>1</i>
<i>Slovenia</i>	<i>1</i>
<i>South Africa</i>	<i>6</i>
<i>Vietnam</i>	<i>1</i>

To change the country code, press Enter and the code will be highlighted. Use the + or – buttons to select the code, and press Enter. The code will now be set.

### **HWIM**

Indicates presence of a Hardwire Interface Module (ACC-HWIM) installed in the controller. "None" indicates no HWIM has been found, "Installed" indicates that the HWIM is installed and has been detected. This display is informational and cannot be changed from the Com module.

### **ENTER DIAGNOSTICS**

To use the built-in communications diagnostics, press the Enter button at this display.

This will allow you to select from the following diagnostic functions (use the up or down arrow buttons to move through the choices).

#### ***Communications Status display [MOD RAD HW]***

Pressing the left arrow button at any time will show a status display for communications, showing transmit and receive activity for each communications type. The display shows: MOD RAD HW #, indicating Modem, Radio, Hardwire, and number of data packets sent.

Under each item MOD, RAD, and HW, the letter T shows transmit activity and R shows receiving data for that communications component. The symbol \* shows other radio traffic ("carrier detect").



This is a useful diagnostic tool.

MOD: Shows dial-up or cellular modem activity.

RAD: Shows T when the controller radio is transmitting, and R when it is receiving data from another radio.

HW: Shows T when the controller is transmitting over GCBL cable, and R when receiving data via GCBL.

#: Shows the count of individual packets of data as they are exchanged. This number continues to increase as events are counted until it reaches 255, then begins again at 1. Digital communications are divided into packets of data, and sent in pieces called "packets". After each packet is sent, a confirming response is expected. This counter tracks all communications in the module via radio, hardwire, and modem.

The \* may indicate other radio traffic (from other sources). Communications problems that cannot be explained by hardware issues are sometimes caused by interference from other sources. If \* is frequently present when no ACC communications are taking place, it may indicate that the frequency is very busy.

## **RADIO TONE TEST**

If the controller does not have a RAD3 radio module installed, the screen will show NONE for this diagnostic function. Press the left arrow button twice to display the Radio Tone Test, and press Enter to start the test. The radio module will transmit a 5-second burst of data, to confirm whether the radio is working. The burst can be heard with another radio or scanner tuned to the same frequency.

For this test to be effective, you will need a two-way radio or scanner on the same frequency as the radio module.

- When the radio test is started, a burst of data indicates a working radio module in the controller.
- If nothing is heard, either the radio is inoperative or the wrong frequency has been selected for receiving.
- If a broken, rough-sounding, or very faint signal is heard, there may be a problem in the antenna, antenna cable, or connectors. This may also indicate a problem in the radio module, although antenna/cable/connectors. This may also indicate a problem in the radio module, although antenna/cable/connectors are more likely the cause. The easiest way to check this is to swap the radio module with a known good unit, connect to the same antenna and cable, and repeat the test... if the sound clears up, the problem was the module. If the sound is still poor, it is probably the antenna/cable/connector setup.

## **PING TEST**

The ping test allows any controller to exchange communications with another controller for test purposes. Select a Target controller from the Source controller. Enter the target address by pressing the + button while the address number is blinking in the main Ping Test screen. Press Enter when the address is correct, and the Ping Test will begin. When the test is started, the Source controller will "ping" the Target controller repeatedly and show success or failure of the communications. Any other controllers which can hear the test will also show the results, while the test is taking place.

## **PING HUB**

This test is used in Surveyor systems to ping test the central interface (AGCHUB) instead of another controller.

## **SOFT RESET**

This "reboots" the communications module if it is temporarily confused. If the display or controls appear to be locked up, soft reset will restart the module without erasing data.

## **TOTAL RESET**

This completely resets all data in the Com module. It will erase any settings including the address! If the com module is unresponsive and a soft reset does not solve the problem, Total reset allows you to start over with a clean installation. This is also useful when moving a Com module from one installation to another, or when you are uncertain what previous operators may have programmed into the module.

## **OPERATING THE COM MODULE**

With the Com module installed and operational, the two most important steps are to verify that the controller address is correct, and that the software is set up correctly to connect to the Site.

The software documentation provides information on configuring Sites and the connections for each Site. In general, a com port must be assigned in the computer for outbound communications, the Site must be created, and a telephone number for the Site must be entered and saved.

When the software has this information, any communications for the Site will use the data to automatically dial and connect to the Master controller and any other controllers on the Site.

# TROUBLESHOOTING.....

Problem	Causes	Solutions
No Display	<p>Check AC~ power to controller</p> <p>Facepack is not firmly seated and locked, and/or 9-pin connector is not fully connected</p> <p>Gray ribbon cable is not connected from back of inner panel to cabinet</p>	<p>Fix power supply</p> <p>Seat facepack in connector</p> <p>Connect ribbon cable on back of facepack door</p>
Display reads "Attention" (may be followed by Sensor number)	<p>ATTENTION indicates an alarm, an active sensor, or trouble in the system. ATTENTION means turn the dial to Data History, select the Alarm Log, and find detailed messages about each individual alarm with date and time. A complete list of alarm messages is included after this table</p>	<p>Turn dial to Data History, select Alarm Logs, and review for individual alarm events</p> <p>The Controller Log and Station Log may also be useful supporting information when diagnosing problems</p>
Station does not irrigate	<p>Field wiring or solenoid problem</p>	<p>Perform Manual One-Station start and observe display and output light</p> <p>If light is red, check solenoid and field wiring, including COM (common) wires. Station outputs must not exceed 0.56A total</p>
Controller does not irrigate automatically	<p>Possible programming errors</p> <p>Sensor shutdown</p> <p>Programmable Off in effect</p> <p>Time/Date errors</p>	<p>Verify all programs Days to Water, Start Times, and Station Run Times</p> <p>Check display for Fault indication (if yes, press + for status)</p> <p>Check display for Off days</p> <p>Verify controller time and date, including AM/PM/24 hour settings</p>
Rain or other Clik sensor does not shut down system	<p>Incorrect sensor type or connection</p> <p>Incorrect sensor settings for Program</p>	<p>Use one normally-closed Clik-type sensor per sensor port (SEN1-4). Verify that one wire from each sensor is to + and one to -. Do not connect multiple sensors to a single port</p> <p>Turn dial to Set Sensor Operation and verify correct response for each program to the sensor (Pause or Suspend)</p>
Controller does not recognize output module (station size shown incorrect)	<p>Module seated incorrectly</p> <p>Module slot skipped</p> <p>Station output module overloaded</p>	<p>Verify that modules are seated all the way up in wiring compartment, and module lock is On</p> <p>Verify that no module slots have been skipped, from left to right</p> <p>Re-seat module, and observe green station light flashing when module is recognized.</p> <p>No station light or red light</p> <p>Swap with known-good module, check for green light. If new module works, replace old module (probably surge overload). If new known-good module also fails to light, check gold and silver contacts for dirt, corrosion, pests.</p>
AC~ fuse blows	<p>Incorrect AC wiring</p> <p>Surge on AC power line</p>	<p>Verify that AC connections are correct for AC~ supply voltage</p> <p>Check for lightning damage in vicinity</p>
Multiple output module failures	<p>Lightning</p> <p>Modules not installed correctly</p> <p>Overcurrent message</p>	<p>Check and improve earth ground</p> <p>Insure that modules are inserted correctly with ground contact in back, and pushed all the way up- red light should light momentarily when module is recognized</p> <p>Too much current for station output (0.56 Amp max). Divide solenoids over more station outputs</p>

## ACC/AGC LOG MESSAGES .....

The controller has 3 separate log files.

Each individual log has the date and time of the event at the top of the screen.

Each type of log will show the most recent event first.

Use the + and – buttons to step through events, forward or backward.

Alarm Log tracks all unusual events that require attention. The Attention display (or “Fault”, in earlier versions) that appears when the dial is in the Run position will almost always have one or more corresponding Alarm Log entries, with more detail. Turn the dial to Data History and select Alarm Log whenever an ATTENTION display occurs.

Controller Log tracks general changes or occurrences for the controller. Most of these are not alarm events.

Station Log tracks all station activity, including normal and abnormal activity. It can be used simply to verify whether irrigation occurred, or used as part of the diagnostic process.

### ALARM LOG MESSAGES

Sensor State Change	Sensor changed state (Closed/Open)
Missed Irrigation	A station missed irrigating
Power Outage	Controller or facepack power was lost
Power Restore	Controller or facepack power was restored
ADM Fault	A fault was reported by ADM
Pump Fault	A pump decoder reported a fault
Station Fault	A station decoder reported a fault
Pump Dec Failure	A pump decoder failed
Sta Dec Failure	A station decoder failed
Sensor Decoder	A sensor decoder reported a fault

### Alarm Log, Missed Irrigation “Mode” Labels

Mode appears when a station failed to complete irrigation for some reason, and indicates why the station was supposed be running in the first place.

Scheduled	Station was running as part of an automatic Field Controller Program (FCP) (A, B, C, D, E, or F)
System Event	Station was running as a System Automatic Event
Manual Prg All	Station was running as part of a Manual All Stations Program
Custom Manual	Station was running as part of a Custom Manual Program
Manual Station	Station was running as a Manual One Station
SME	Station was running as a System Manual Event
MR Program	Station was running as part of a Manual All Stations program started by Maintenance Radio
MR SSG	Station was running as part of a SSG started by MR
MR Station	Station was running as a Manual One Station started by MR
ICR Program	Station was running as part of a Manual All Stations program started by ICR remote
ICR Station	Station was running as a Manual One Station started by ICR
ETS Program	Station was running as part of a Manual All Stations started by ET System
ETS Station	Station was running as a Manual One Station started by ET System
Learn Event	Station was running as part of the Learn process
Test Event	Station was running as part of the Test program

### Alarm Log, "Reason" Labels

The Reason label indicates the type of alarm condition.

Unknown	No reason specified
Overflow	Overflow alarm occurred
Underflow	Underflow alarm occurred
Overcurrent	Station Overloaded
Activated	Sensor Activated
Deactivated	Sensor Deactivated
Damaged	Decoder is damaged (continuous low voltage output)
Comm Fail	Decoder communications failure - no response
Unavailable	Cannot run station due to too many stations already running
Comm Restore	Communications was restored to a decoder
Config Fail	Failure occurred when attempting to configure a sensor decoder on the 2-wire path
Flow Totals	Failure occurred when attempting to get the flow totals from a sensor decoder
Flow Detail	Failure occurred when attempting to get the flow detail data from a sensor decoder
Sensor Alarm	The status of the Sensor Decoder Alarm Polling has changed
Lith Fail	The lithium battery in the facepack has failed
Clock Fail	A problem exists with the Real Time Clock (RTC) in the facepack

### CONTROLLER LOGS

Track significant events at the controller, which are not necessarily alarms or malfunctions.

Message	Description
EASY RETRIEVE RESTORED	Easy retrieve programs were restored
PROGRAM X RESET BY CENTRAL	Field controller Program X was reset by central
OFF MODE SET AT CONTROLLER	Dial was put in OFF position
RUN MODE SET AT CONTROLLER	Dial was taken out of OFF position
PROGRAMMABLE OFF SET AT CONTROLLER	Programmable Off was initiated at the controller
PAUSE MODE SET AT CONTROLLER	Pause Mode was initiated at the controller
PAUSE MODE CANCELLED AT CONTROLLER	Pause Mode was cancelled at the controller
PROGRAMMABLE OFF SET BY CENTRAL	Programmable Off was initiated by central
PAUSE MODE SET BY CENTRAL	Pause Mode was initiated by central
PAUSE MODE CANCELLED BY CENTRAL	Pause Mode was cancelled by central
SUSPEND MODE SET BY CENTRAL	Suspend Mode was initiated by central
SUSPEND MODE CANCELLED BY CENTRAL	Suspend Mode was cancelled by central
PROGRAMMABLE OFF TIMEOUT	Programmable Off timed out
PAUSE TIMEOUT	Pause timed out
NO WATER WINDOW VIOLATION	A No Water Window Violation occurred
MEMORY CORRUPTED RESET TO DEFAULTS	Memory is suspect and was reset to defaults by microcontroller
ALL DATA RESET TO DEFAULTS	All data was reset in the controller
ALL LOGS RESET AT CONTROLLER	All logs were reset at the controller
FLOW TOTALS RESET AT CONTROLLER	All flow totals were reset at the controller
ALL PROGRAM DATA RESET AT CONTROLLER	All programs were reset at the controller
ALL NAMES RESET AT CONTROLLER	All names were reset at the controller
IRRIGATION STOPPED BY CENTRAL	Irrigation was stopped by the central

Message	Description
IRRIGATION STOPPED BY MAINT RADIO	Irrigation was stopped by maintenance radio
PAUSE MODE SET BY MAINT RADIO	Pause Mode set by Maintenance Radio
PAUSE MODE CANCELLED BY MAINT RADIO	Pause Mode cancelled by Maintenance Radio
FCP MODE SET AT CONTROLLER	FCP Mode set at controller
EVENT MODE SET AT CONTROLLER	Event Mode set at controller
FCP MODE SET BY CENTRAL	FCP Mode set by central
EVENT MODE SET BY CENTRAL	Event Mode set by central
PROG OFF CANCELLED AT CONTROLLER	Programmable Off was cancelled at controller
CUST MAN PROGRAM X RESET BY CENTRAL	Custom Manual Program X was reset by the central
ALL FCPs RESET BY CENTRAL	All Field Controller Programs (A to F) were reset by central
ALL CUST PROGRAMS RESET BY CENTRAL	All Customer Manual Programs (1 to 4) were reset by central
ALL STATION DATA RESET BY CENTRAL	All station related data was reset by central
ALL SSG DATA RESET BY CENTRAL	All SSG related data was reset by central
ALL P/MV DATA RESET BY CENTRAL	All Pump/Master Valve data was reset by central
ALL SENSOR DATA RESET BY CENTRAL	All Sensor 1 to 4 data was reset by central
ALL FLOW SENSOR DATA RESET BY CENTRAL	All Flow Sensor data was reset by central
FLOW ACCUMULATORS RESET BY CENTRAL	All Flow Accumulators were reset by central
FLOW TOTALS RESET BY CENTRAL	All Flow Totals were reset by central
TIME OR DATE CHANGED AT CONTROLLER	The time and/or date was changed at the controller
TIME OR DATE CHANGED BY CENTRAL	The time and/or date was changed by the central

## STATION LOGS

Station Log records all station activity in the controller.

The Mode labels are the same as shown in the Run dial position, when stations are running.

Mode	Meaning
AUTO	Automatic Field Controller Program (FCP)
AUTOEV	Automatic System Event
MAN	Manual Station/Program
CUST	Custom Manual Program
MAN-EV	Manual System Event
MRP	Maintenance Radio Program
MRS	Maintenance Radio Station
ICR	ICR Program/Station
ETS	ET System Program/Station
LEARN	Learn Mode
TEST	Test Program
PAUSE	Paused Program/Station
SUSP	Suspended Program/Station

The Status portion shows the type of event, or the reason a station did not complete. Each start and stop of a station is recorded. If a station has a "Pause" or "Delayed" event, it does not necessarily indicate a malfunction. There are several causes that may occur during normal irrigation.

Status	Description
System Pause	Pause issued by controller or central
System Susp	Suspend issued by central
Sensor Pause	Pause initiated from sensor activation
Sensor Susp	Suspend initiated from sensor activation
No Water Win	Station ran into no water window
Complete	Station completed run time
Delayed	Soak completed
Interrupted	Indicates that a station was interrupted by pause/suspend
Max Sta Run	Station could not run since max stations were already running
Overcurrent	Station shut down due to overcurrent
Stopped	Station was stopped due to dial put in Off, Stop Irrigation command received or higher priority event
Man Sta Chg	Station stopped due to manual station advance
Flow Pause	Irrigation was delayed due to flow isolation process
ADM Flt Susp	Irrigation was suspended due to an ADM fault
Dec Com Fail	Irrigation was stopped due to a comm failure with decoder

# SPECIFICATIONS .....

## DIMENSIONS

ACC1200,ACC99D Cabinet :

12 $\frac{3}{8}$ " H x 15" W x 6 $\frac{7}{16}$ " D

(31.37 cm H x 39.37 cm W x 16.38 cm D)

ACCPED Metal Pedestal:

36 $\frac{1}{8}$ " H x 15" W x 5" D

(91.45 cm H x 39.37 cm W x 12.7 cm D)

ACC1200PP, ACC99D-PP Plastic Pedestal:

38 $\frac{3}{8}$ " H x 21 $\frac{1}{16}$ " W x 15 $\frac{7}{8}$ " D

(97.47 cm H x 54.61 cm W x 40.32 cm D)

## ELECTRICAL

### *Transformer Input*

Supply wires must be 14 AWG (1.85 mm) or larger!

120/230 VAC

50/60 Hz

1.2 A max at 120V/0.73 A max at 230V

### *Transformer output*

24 VAC, 4A, @ 120 VAC

Station output: 0.56 A @ 24 VAC

Pump/Master Valve output: 325 mA @24 VAC

24 VAC Test terminal output: 420 mA @ 24 VAC

Solenoid capacity: 2 standard 24 VAC Hunter solenoids per output (0.56 Amps max), 14 solenoids max simultaneous (includes dual P/MV outputs).

Battery, facepack: 9 VDC alkaline, for facepack remote power only.

Battery, facepack, internal: CR2032 lithium for real time clock only.

### *Cleaning*

Clean only with cloth dampened with mild soapy water.

## FEATURES & GENERAL SPECIFICATIONS

- 6 Automatic Programs
- 10 Start Times per program
- Station Run Times, 1 second to 6 hours in Conventional Controllers, and 15 seconds to 6 hours in Decoder Controllers
- Delay between Stations, 1 second to 9 hours, 59 minutes
- Interval Day scheduling, 1 to 31 days
- 4 Custom Manual programs (for manual or remote start only)
- 20 Simultaneous Station Groups with up to 4 stations each
- 2 normally closed Pump/Master Valve outputs, configured by station
- 1 Flow Meter, with Station level learning and diagnostics
- 4 Hunter "Clik" sensor inputs, with programmable shutdown by program
- Test Program run times: Conventional, 1 second to 15 minutes each, Decoder, 15 seconds to 15 minutes each
- Up to 42 stations, conventional
- Up to 99 stations, decoder

# PARTS

## WALL MOUNT CONTROLLERS (ACC1200, ACC99D)

Item	Description	Catalog No.
①	Front Faceplate Face Pack	571500
②	Front Face Pack Door Frame	589000
③	Metal Front Door w/o Lock	585500
④	Lock & Key Set <i>(Not Shown)</i>	387300
⑤	Key Set (2) <i>(Not shown)</i>	122516
⑥	Metal Cabinet w/o Door	585000
⑦	Inner Controller only <i>(With 585100), no modules or transformer</i>	586005
⑧	Door Ribbon Cable <i>(Wall mount only)</i>	585100
⑨	Transformer Assembly	587000
⑩	Master Module	572000
⑪	Small Hole Plug	654400
⑫	Large Hole Plug	654500
⑬	Station Module(s) ACM-Module <i>(Standard)</i> AGM-Module <i>(Extreme service)</i>	ACM600 AGM600
⑭	SmartPort® Assembly including Nut	112200
⑮	Decoder Output Module	ADM99

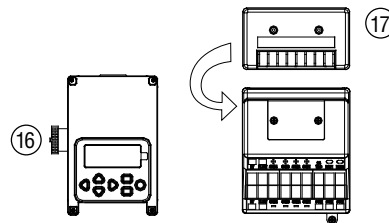
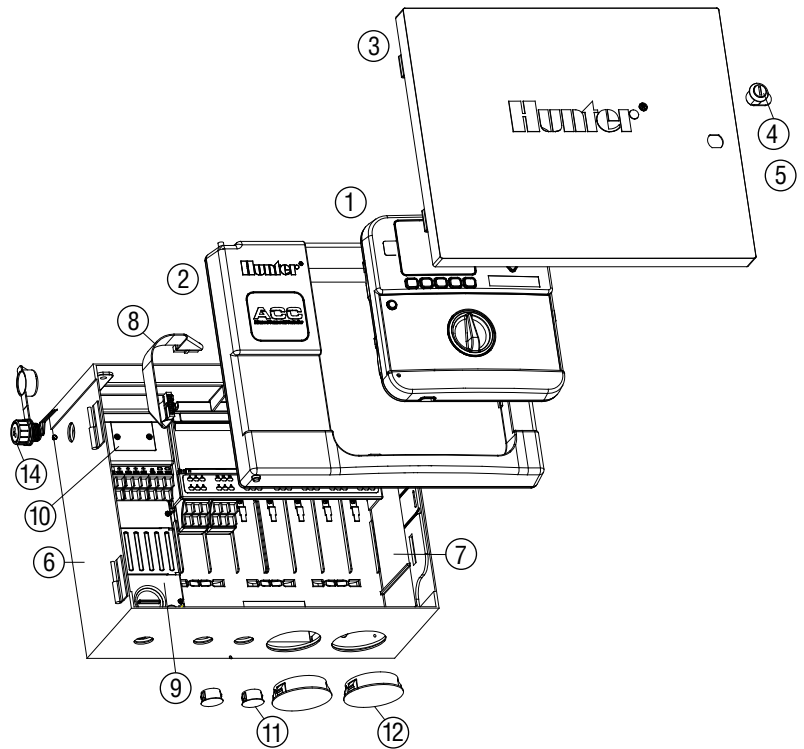

## COMMUNICATION MODULES AND PARTS

Item	Description	Catalog No.
⑯	Com module for dial-up <i>(POTS)</i>	ACC-COM-POTS
⑯	Com module for GSM cell <i>(USA)</i>	ACC-COM-GSM
⑯	Com module for GSM, International	ACC-COM-GSM-E
⑯	Com module for radio and hardwire only	ACC-COM-HWR
⑰	Hardwire Interface Module	ACC-HWIM
⑱	UHF radio <i>(No antenna)</i>	RAD3
⑲	Antenna Isolation Module	AIM-BNC

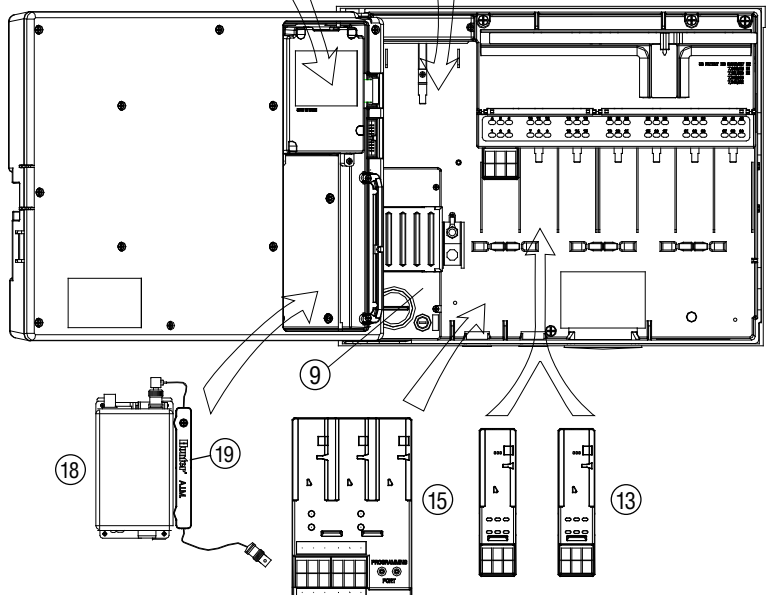

## PEDESTAL CONTROLLERS (ACC1200PP, AGC1200PP, ACC99DPP, AGC99DPP)

Item	Description	Catalog No.
①	Front Faceplate Face Pack (ACC)	571500
	Front Face Pack (AGC)	571505
②	Front Face Pack Door only	620000
③	Plastic Ped Com and Radio Bracket, including Ribbon Cable	APPBRKT
④	Frame Adapter	145500
⑤	Lid including Lock	553305
⑥	Lid Antenna for Ped, UHF	IMMSANT2
⑦	Lid Hinge Pin	558400
⑧	SmartPort® Bracket	576000
⑨	SmartPort® Wiring Harness	112210
⑩	Master Module	572000
⑪	Decoder Output Module	ADM99
⑫	Transformer Assembly	587000
⑬	J Box	145410
⑭	Pedestal Door with Screen	553205
⑮	Lock & Key Set <i>(Not shown)</i>	558000
⑯	Key Set (2) <i>(Not shown)</i>	122516
⑰	ACC Ped Inner Panel Cabinet with Transformer	621230
⑱	Ribbon, Inner Controller to Facepack Door	585105
⑲	Mounting Template Kit, includes Template #558600, and Hardware #420200	581700
⑳	Ribbon, Extension for Com Modules in Pedestals	619900
	Station Module(s) ACM-Module (Standard) AGM-Module (Extreme Service)	ACM600 AGM600

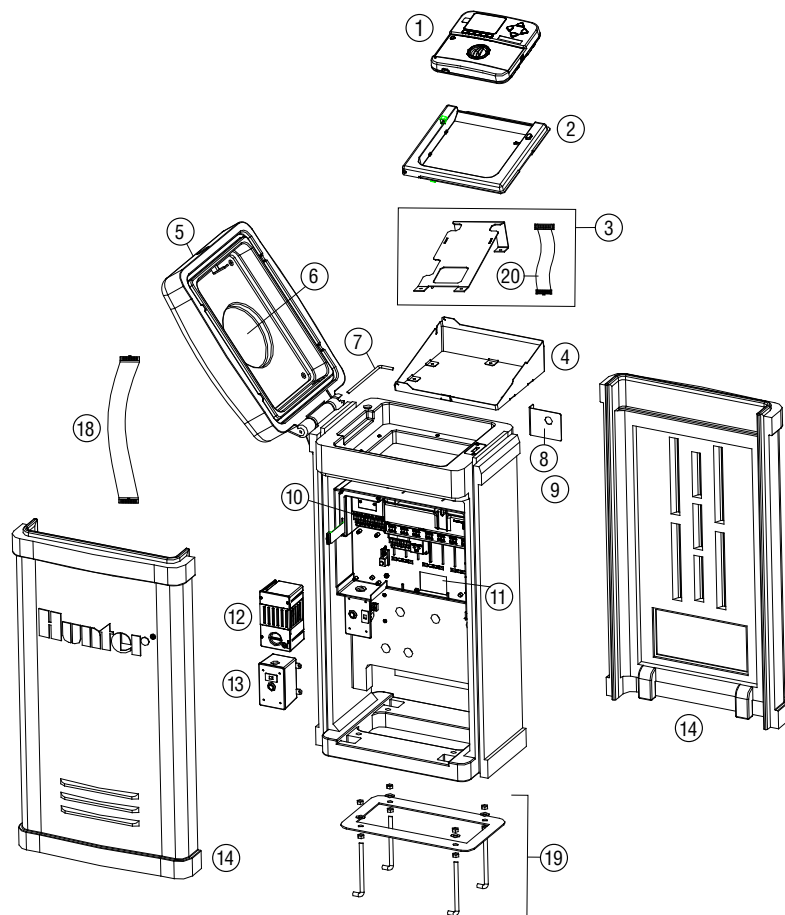

## ACC/AGC CENTRAL SYSTEM COMPONENTS (ACC1200, ACC99D, ACC1200PP, AGC1200PP, ACC99DPP, AGC99DPP)

①	Hardwire/Radio Communication Module	ACC-COM-HWR
②	Telephone Communication Module	ACC-COM-POTS
③	Cellular Communication Module	ACC-COM-GSM
④	Cellular Communication Module outside US	ACC-COM-GSM-E
⑤	Radio Communication Module	RAD3
⑥	Hardwire Interface Module	ACC-HWIM
⑦	ET Sensor for IMMS ET	ETSENSOR



# INDEX

---

## A

Address 16, 57, 59, 61, 62, 77, 80, 82  
Adjustment 22, 64, 67, 69, 72  
ADM 19, 24, 25, 34, 41, 42, 46, 47, 57, 59, 60, 63, 84, 86  
Alarm 14, 27, 28, 29, 31, 32, 33, 34, 35, 38, 39, 41, 42, 56, 62, 63, 70, 71, 73, 74, 84, 85  
Antenna 18, 77, 78, 79, 82, 88  
Attention 29, 32, 42, 44, 70, 84

## C

Cable 1, 4, 17, 77, 78, 79, 82  
CCC 18  
Clik 13, 15, 33, 35, 60, 61, 73, 74, 87  
Comm 86  
Comm failure 86  
Communications 2, 10, 13, 17, 18, 39, 64, 71, 72, 77, 78, 80, 81, 82, 85  
Communications manager 77  
Com port 82  
Controller log 39, 69, 70, 84  
CSD 17, 18  
Custom 54  
Custom manual 19, 33, 50, 53, 84, 86, 87  
Cycle 24, 44, 50, 54  
Cycle and soak 24, 50, 54

## D

Daily 38  
Data history 38  
Date/time 18, 73  
Daylight saving 17, 20  
Day schedules 56  
Days to water 18, 22, 52  
Decoder 12, 16, 19, 24, 25, 30, 33, 40, 41, 46, 47, 51, 56, 59, 61, 63, 84, 85, 86, 87  
Deficit 72  
Delay 28, 29, 35, 45, 50, 74  
Dial 1, 2, 11, 13, 17, 19, 20, 21, 22, 24, 25, 26, 27, 28, 29, 32, 33, 34, 35, 36, 37, 38, 39, 40, 42, 44, 45, 46, 47, 48, 50, 51, 52, 53, 54, 55, 57, 58, 59, 60, 62, 63, 64, 65, 66, 67, 68, 69, 70, 71, 72, 73, 75, 77, 82, 84, 86, 88  
Dial tone 17

Download 40, 59, 76

## E

Earth 5, 8  
Easy retrieve 85  
ET 72  
ET sensor 13, 30, 34, 35, 41, 64, 65, 72, 73, 74, 89  
Evapo-transpiration 64  
Event 86  
Event mode 86

## F

Facepack 2, 64, 89  
Fault 11, 19, 84, 86  
Firmware 26, 35, 40, 64  
Flow 15, 19, 25, 26, 27, 28, 29, 30, 33, 38, 46, 47, 56, 60, 85, 86, 87  
Freeze 15, 30, 35, 61, 74  
Frequency 80

## G

Gallons 26, 38, 69  
GCBL 17, 77, 78, 82  
GLBL 22, 67  
Global 22  
Golf 75  
Ground 5, 10  
GSM 17, 18, 77, 78, 88, 89

## H

Hardwire 13, 81, 88, 89

## I

ICR 3, 16, 50, 54, 77, 80, 84, 86  
Inrush 58  
Installation 2, 4, 6, 11, 25, 46, 48, 56, 63, 65, 77, 78, 79, 80, 82  
Interval 18, 23, 87

## L

Learn 25, 27, 28  
Lights 2, 57  
Limit 19, 26, 28, 29, 30, 43  
Line 17, 37, 41, 48, 49, 56, 63, 77

Liters 26, 38, 69  
Log 18, 29, 32, 38, 39, 41, 42, 44, 69, 71, 84, 85, 86

## **M**

Manual 14, 15, 17, 31, 36, 39, 41, 47, 48, 50, 54, 68, 76, 86, 87  
Master module 25, 34, 46, 64, 65, 72, 73  
Metric 20, 46  
Millimeters 72, 73  
Modem 1, 78, 81, 82

## **N**

Non-water window 44  
Normally closed 13, 14, 24, 30, 31, 34, 45, 87  
Normally Closed 24, 32, 45, 46, 59  
Not learned 26, 28  
Not monitored 26, 27, 28

## **O**

OFF 8, 17, 19, 21, 30, 32, 39, 54, 55, 56, 63, 78, 85, 86  
Output 3, 10, 12, 13, 14, 16, 19, 25, 33, 40, 41, 42, 46, 47, 51, 56, 57, 58, 59, 60, 61, 63, 85, 87  
Overcurrent 39, 41, 42, 85, 86  
Overflow 29, 39, 42, 85  
Overlap 17, 20, 21, 36, 37  
Overload 63

## **P**

Parts 88  
Path 12  
Pause 2, 29, 31, 32, 33, 35, 42, 62, 68, 73, 74, 85, 86  
Pedestal 6, 7, 16, 17, 77, 79  
Percentage 22, 43, 67  
P/MV 23, 24, 42, 45, 54, 59, 86, 87  
POTS 17, 77, 78, 79, 88, 89  
Power 3, 5, 6, 7, 8, 11, 13, 14, 15, 18, 43, 56, 57, 58, 65, 78, 79, 84, 87  
Power factor 58  
Program 18, 19, 20, 21, 22, 23, 24, 27, 30, 31, 32, 33, 35, 36, 37, 38, 40, 44, 45, 47, 48, 49, 50, 51, 52, 53, 54, 57, 58, 59, 61, 62, 64, 67, 68, 73, 84, 85, 86, 87  
Pump 3, 13, 14, 18, 23, 24, 30, 42, 46, 58, 59, 63, 84, 86, 87  
Pump/master valve 3, 13, 18, 46, 59, 86, 87

## **R**

Radio 1, 17, 18, 77, 78, 79, 80, 81, 82, 86, 88  
Rain 14, 15, 30, 31, 34, 35, 55, 67, 68, 70, 71, 73, 74  
Rainfall 35, 72, 74  
Rain off 55  
Receive 19, 30, 57, 60, 63, 65, 80, 81  
Region 69  
Relay 14, 31, 42  
Remote control 16, 48, 77, 80  
Replace 5, 6, 28, 39, 49, 52, 64  
Report 29, 43, 59, 72  
Restore 52  
Retrieve 39, 52, 56  
Ribbon 4, 78, 79  
Run off 24  
Run times 22, 27, 50, 51, 52, 54, 56, 64, 67, 69, 72, 87

## **S**

Save 37, 38, 44, 45, 47, 48, 50, 52, 68  
Scheduling 76, 87  
Seasonal adjust 21, 22, 44, 64, 67  
Sensor decoder 19, 25, 30, 33, 41, 47, 59, 60, 61, 62, 63, 84, 85  
Sensors 1, 13, 14, 15, 16, 19, 25, 30, 31, 33, 34, 35, 46, 59, 60, 61, 67, 68, 70, 73, 74  
Shutdown 1, 14, 17, 30, 32, 35, 67, 68, 73, 74, 87  
Site 18, 37, 64, 77  
Smartstack 37, 48  
Soak 24, 44, 50, 54, 86  
Solar 64, 65  
Solar-sync 64, 65, 66, 67, 68, 69, 70, 71  
Solenoid 12, 14, 41, 57, 58  
Specifications 87  
Sprinkler 4, 21, 31, 37, 81  
SSG 17, 19, 36, 37, 38, 47, 48, 49, 50, 51, 53, 54, 81, 84, 86  
SSG/smartstack 37, 48  
Stack 20, 21, 36, 53  
Stacking 17, 20  
Start time 20, 23, 30, 36, 44, 53  
Station A, 3, 5, 6, 11, 18, 19, 21, 22, 24, 27, 33, 37, 38, 39, 40, 44, 45, 47, 48, 50, 51, 53, 54, 58, 59, 63, 67, 69, 84, 85, 86, 87, 88, 89  
Status 3, 11, 12, 26, 32, 40, 56, 57, 81, 86

**Stop** 13, 16, 17, 30, 31, 35, 39, 42, 51, 53, 54, 68, 74, 86

**Summary** 19, 21, 22, 24

**Suspend** 30, 31, 32, 85

**Sync** 72

**System** 16, 17, 18, 33, 54, 72, 75, 76, 84, 86, 89

## **T**

**Technical support** 40

**Telephone** 1, 17, 18, 37, 77, 78, 79, 81, 82

**Temperature** 30, 35, 40, 64, 69, 73, 74

**Test** 2, 14, 19, 33, 51, 52, 66, 82, 84, 86, 87

**Toggle** 23

**Totals** 38, 42, 76, 85

**Transformer** 42

**Transmit** 81, 82

**Troubleshoot** 67

## **U**

**UHF** 17, 18, 77, 80, 88, 89

**Underflow** 29, 30, 39, 43, 85

**Update** 13, 40, 64, 73

## **V**

**Version** 13, 26, 30, 39, 40, 44, 64, 72, 80

## **W**

**Wind** 30, 35, 73, 74

**Window** 21, 36, 44, 47, 86

**Wire** 3, 5, 6, 8, 10, 12, 13, 14, 15, 16, 17, 24, 25, 33, 41, 42, 46, 47, 56, 57, 59, 60, 61, 62, 63, 67, 77, 78, 85

**Wiring** 3, 5, 6, 8, 10, 11, 12, 13, 15, 41, 56, 67, 71, 73, 77

## **Z**

**Zone** 30, 72

