

Product Installation Guide

Hunter®

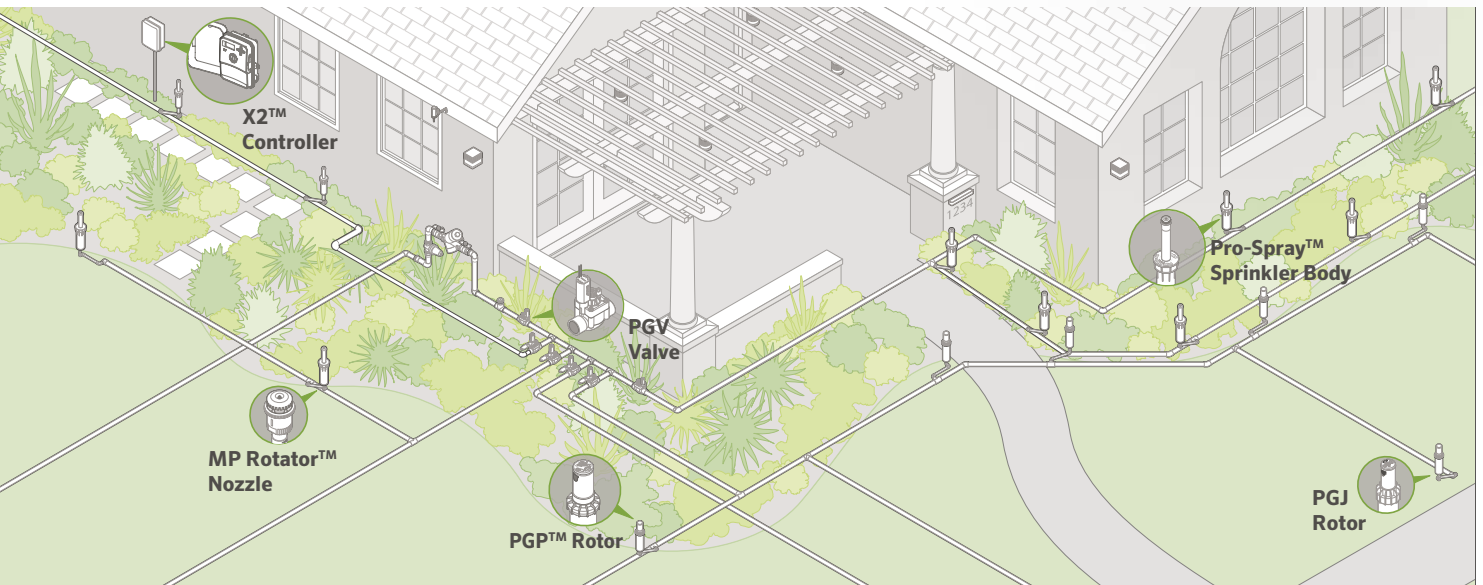

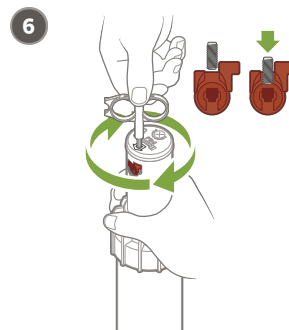

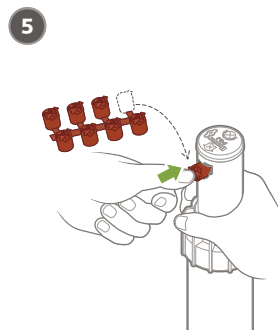
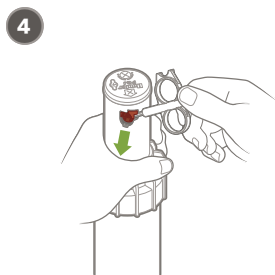
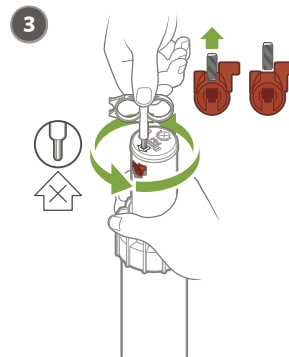
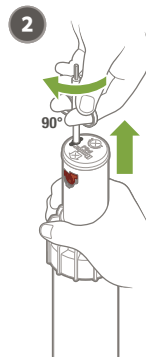
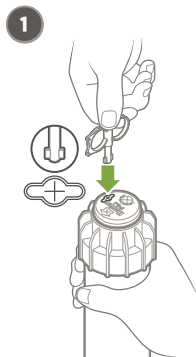
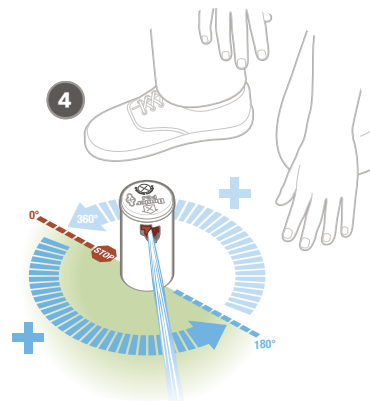
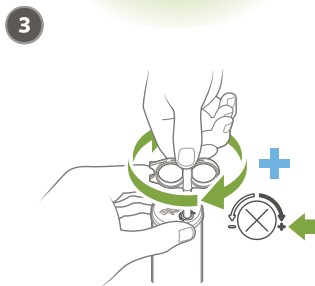
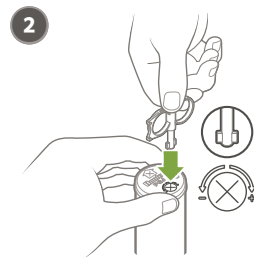
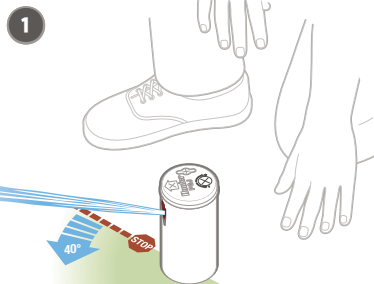
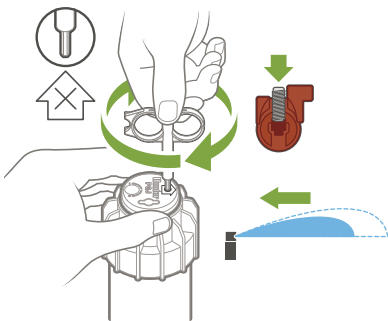
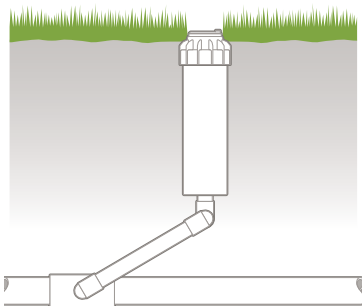

0.50

1.7 to 3.8 bar
170 to 380 kPa
30 to 50 PSI



1.4 to 2.3 l/m
0.4 to 0.6 GPM



4.3 m to 4.9 m
(14' to 16')

0.75

1.7 to 3.8 bar
170 to 380 kPa
30 to 50 PSI



2.2 to 3.4 l/m
0.6 to 0.9 GPM



4.6 m to 5.2 m
(15' to 17')

1.0

1.7 to 3.8 bar
170 to 380 kPa
30 to 50 PSI



3.0 to 4.2 l/m
0.9 to 1.1 GPM



5.5 m to 5.8 m
(18' to 19')

1.5

1.7 to 3.8 bar
170 to 380 kPa
30 to 50 PSI



4.5 to 6.7 l/m
1.3 to 1.7 GPM

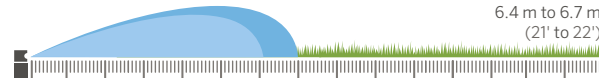

6.4 m to 6.7 m
(21' to 22')



2.0



1.7 to 3.8 bar
170 to 380 kPa
30 to 50 PSI



5.6 to 9.3 l/m
1.7 to 2.3 GPM

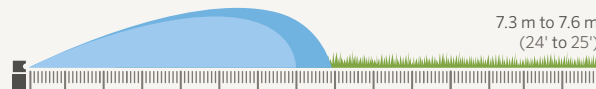

2.5



1.7 to 3.8 bar
170 to 380 kPa
30 to 50 PSI



7.6 to 10.9 l/m
2.2 to 2.8 GPM

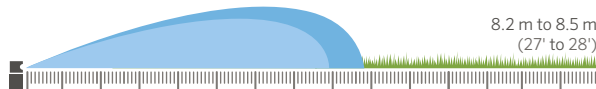

3.0



1.7 to 3.8 bar
170 to 380 kPa
30 to 50 PSI



8.5 to 13.7 l/m
2.5 to 3.4 GPM

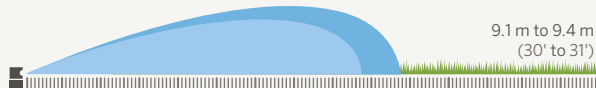

4.0



1.7 to 3.8 bar
170 to 380 kPa
30 to 50 PSI



13.3 to 16.7 l/m
3.7 to 4.3 GPM





PGP-ADJ



1

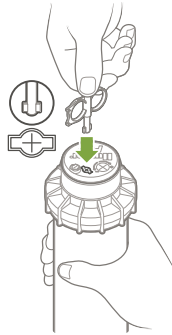

2

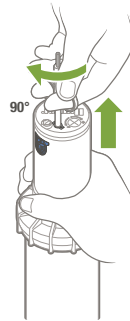

3

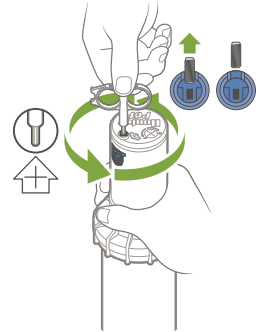

4

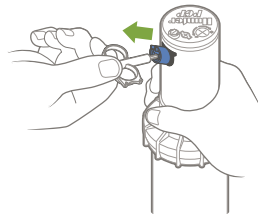

5

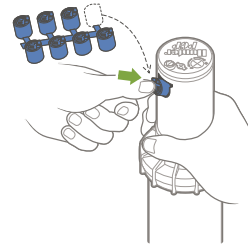

6

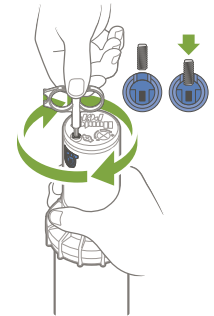

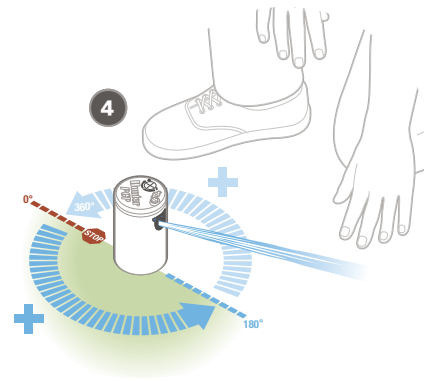
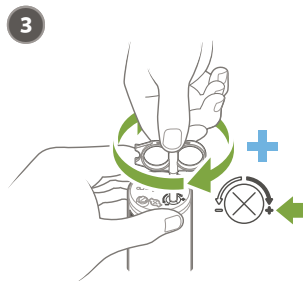
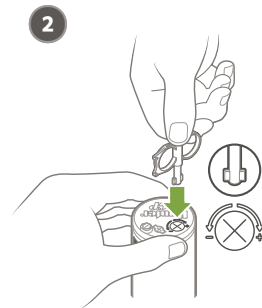
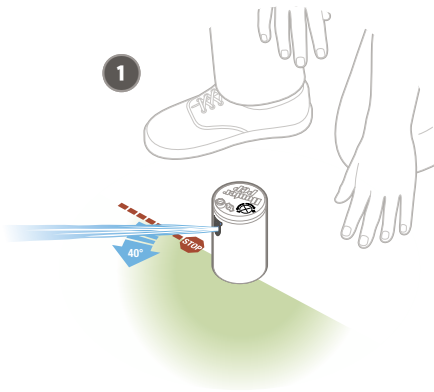
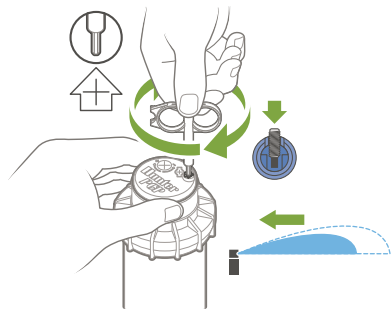
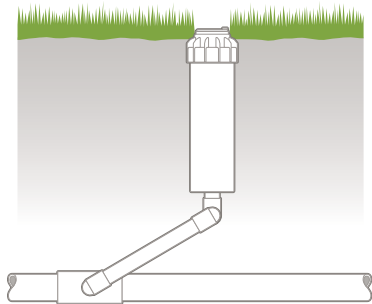



1.5

1.7 to 4.5 bar
170 to 450 kPa
25 to 65 PSI

4.5 to 7.2 l/m
1.2 to 1.9 GPM

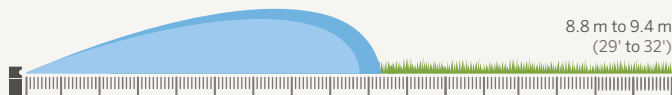

8.8 m to 9.4 m
(29' to 32')



2.0

1.7 to 4.5 bar
170 to 450 kPa
25 to 65 PSI

5.4 to 8.8 l/m
1.4 to 2.3 GPM

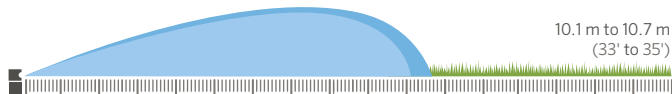

10.1 m to 10.7 m
(33' to 35')



2.5

1.7 to 4.5 bar
170 to 450 kPa
25 to 65 PSI

6.6 to 11.1 l/m
1.7 to 2.9 GPM



10.1 m to 10.7 m
(33' to 35')



3.0

1.7 to 4.5 bar
170 to 450 kPa
25 to 65 PSI

8.4 to 14.0 l/m
2.2 to 3.7 GPM

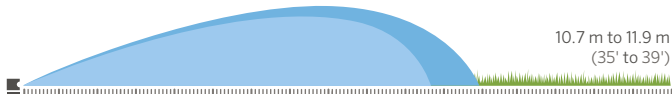

10.7 m to 11.9 m
(35' to 39')

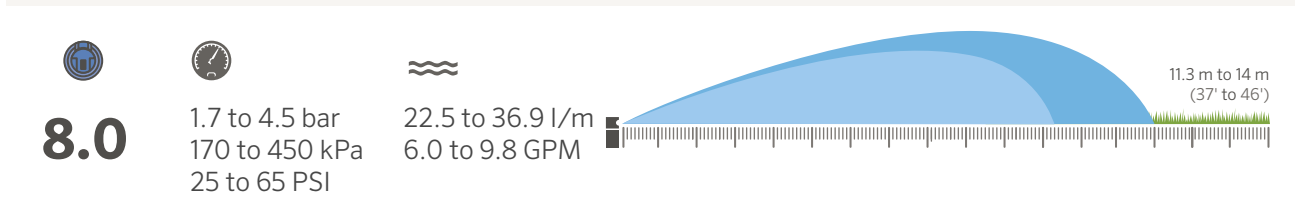
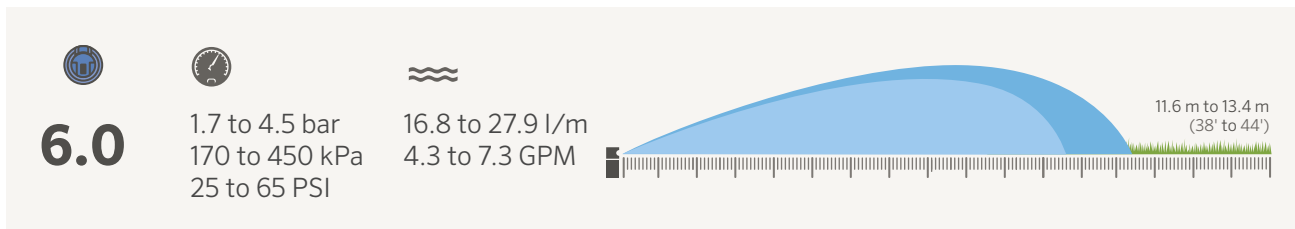
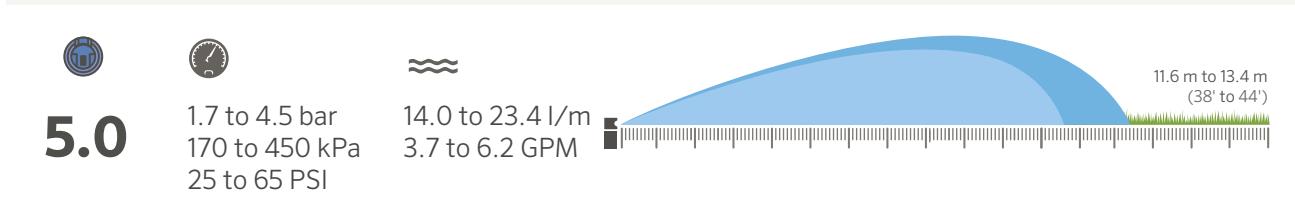
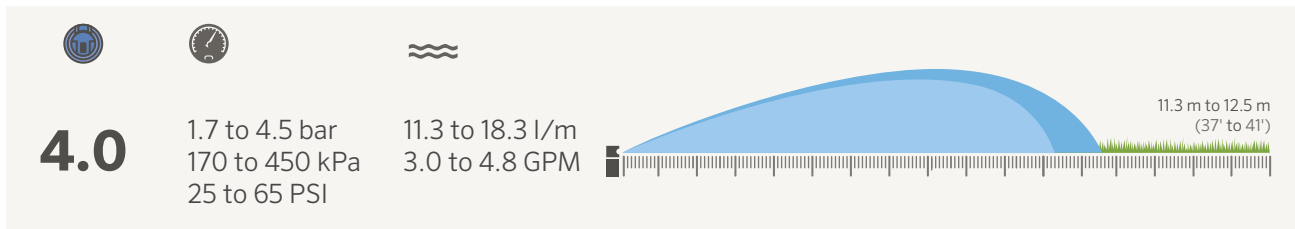

MP ROTATOR™



hunter.info/MPREM

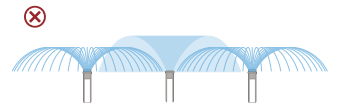
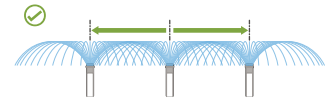
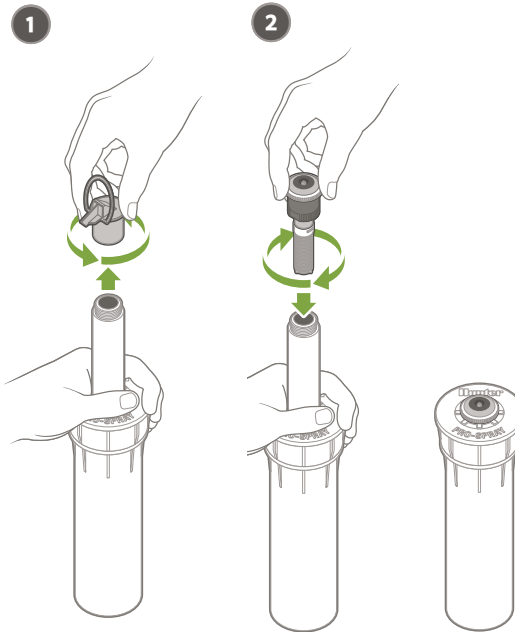

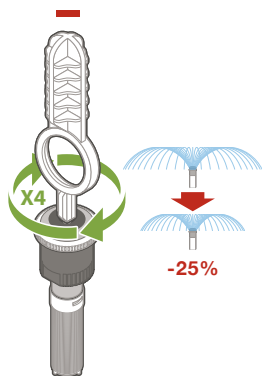
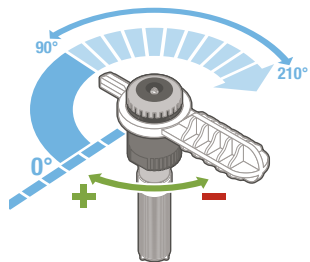

MP-800SR-90



MP-800SR-360



MP-800SR

20 mm/hr (0.8 in/hr)
1.8 m to 3.5 m (6' to 12')



MP-815-90



MP-815-210



MP-815-360



MP-815

20 mm/hr (0.8 in/hr)
2.5 m to 4.9 m (8' to 16')



MP-820-90



MP-820-210



MP-820-360



MP-820

20 mm/hr (0.8 in/hr)
4.6 m to 6.7 m (15' to 22')



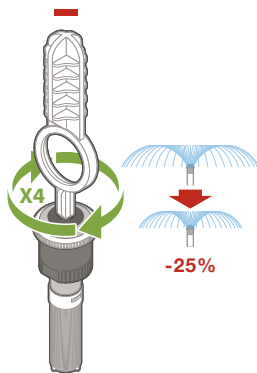
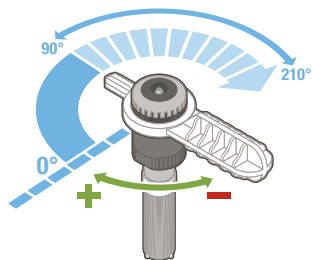

90° to 210° 210° to 270° 360°



MP-1000-90 MP-1000-210 MP-1000-360



MP-1000

10 mm/hr (0.4 in/hr)
2.5 m to 4.5 m (8' to 15')



MP-2000-90 MP-2000-210 MP-2000-360



MP-2000

10 mm/hr (0.4 in/hr)
4 m to 6.4 m (13' to 21')

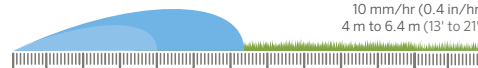

MP-3000-90 MP-3000-210 MP-3000-360



MP-3000

10 mm/hr (0.4 in/hr)
6.7 m to 9.1 m
(22' to 30')

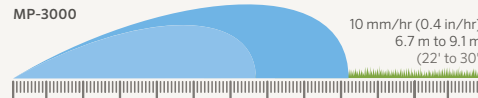

MP-3500-90



MP-3500

10 mm/hr
(0.4 in/hr)
9.4 m to 10.7 m
(31' to 35')

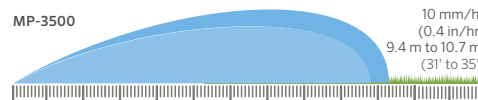

PS ULTRA / PRO-SPRAY™



1

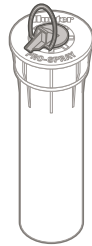

2

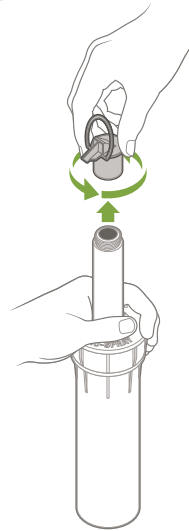

3

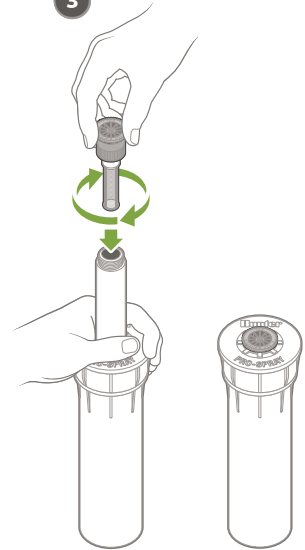

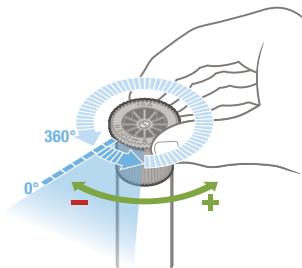
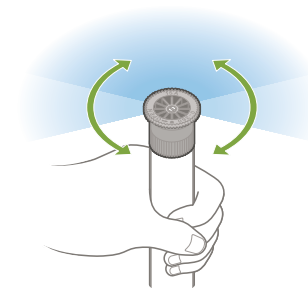
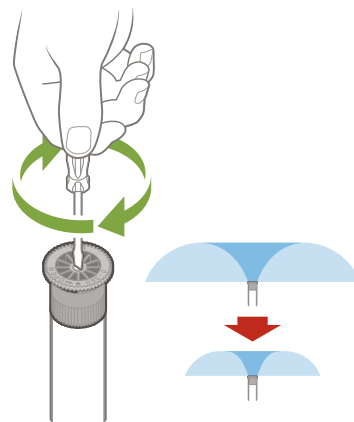
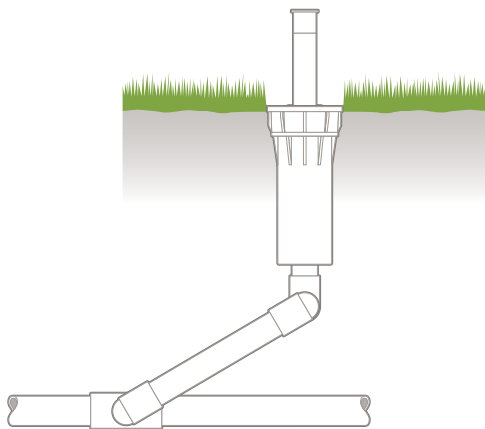



8A



1.0 to 3.0 bar
100 to 300 kPa
20 to 40 PSI



0.6 to 8.1 l/m
0.2 to 2.0 GPM



2.0 m to 2.9 m
(7' to 9')



10A



1.0 to 3.0 bar
100 to 300 kPa
20 to 40 PSI



0.7 to 9.5 l/m
0.2 to 2.3 GPM



2.6 m to 3.5 m
(9' to 11')



12A



1.0 to 3.0 bar
100 to 300 kPa
20 to 40 PSI



0.7 to 13.4 l/m
0.3 to 3.4 GPM



3.2 m to 4.1 m
(11' to 13')



15A



1.0 to 3.0 bar
100 to 300 kPa
20 to 40 PSI



1.3 to 18.0 l/m
0.4 to 4.5 GPM



4.0 m to 5.2 m
(14' to 17')

●
17A



1.0 to 3.0 bar
100 to 300 kPa
20 to 40 PSI



1.7 to 21.7 l/m
0.5 to 5.5 GPM



■
SS-530



1.0 to 2.5 bar
100 to 250 kPa
20 to 40 PSI



3.5 to 55 l/m
1.1 to 1.5 GPM

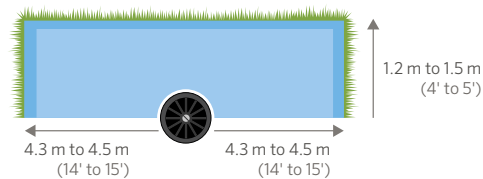

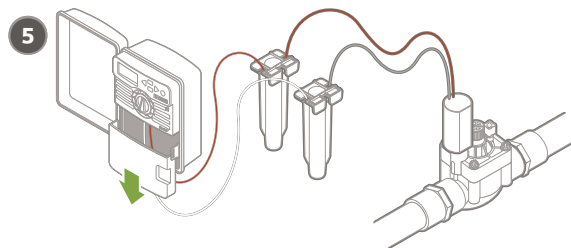
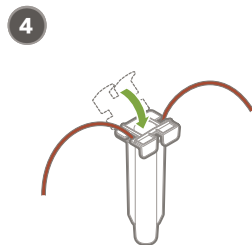
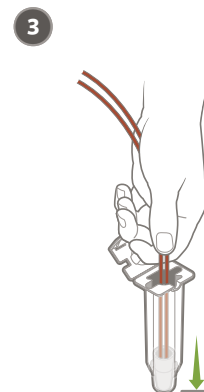
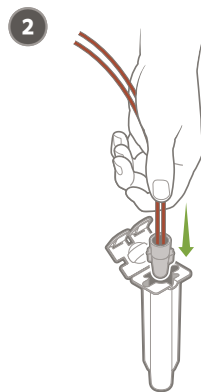
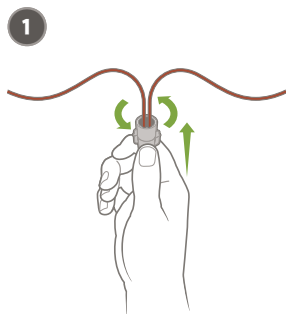

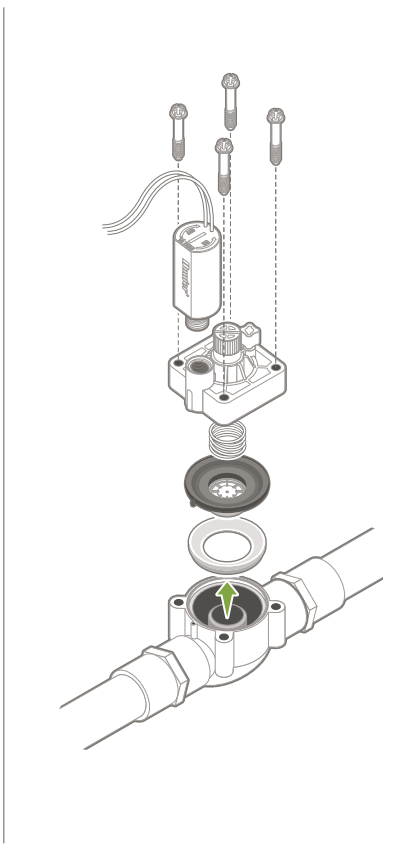
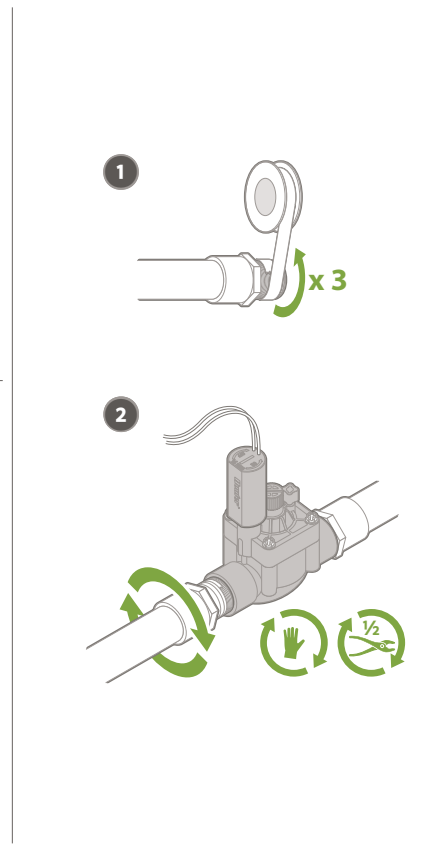
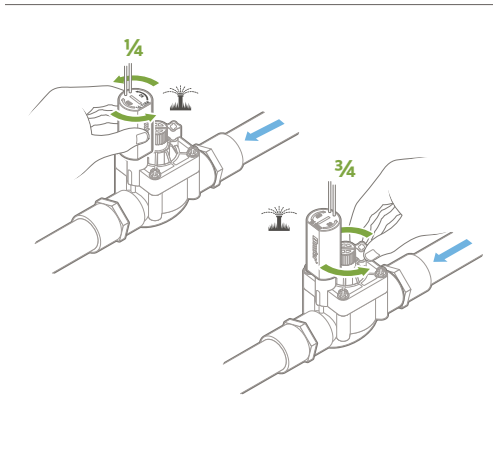
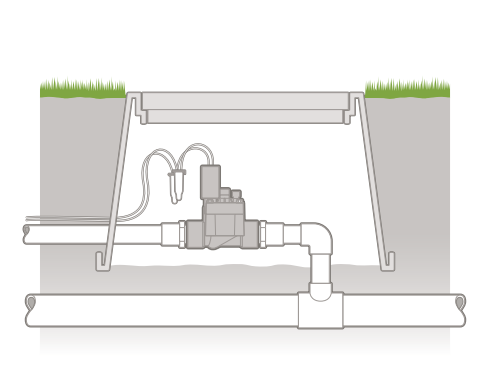

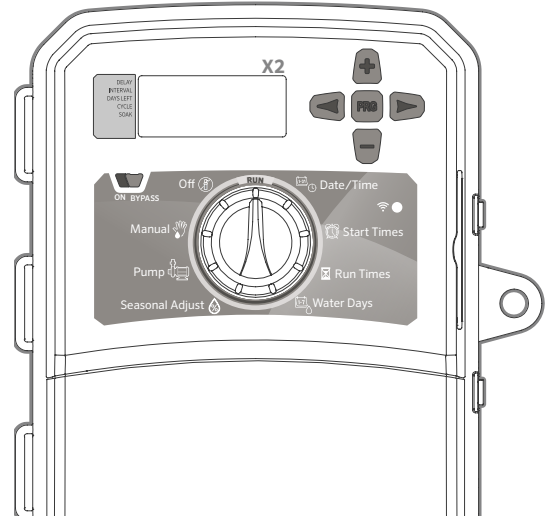
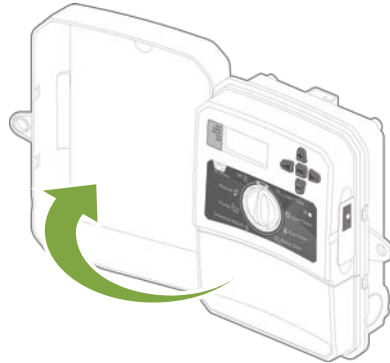

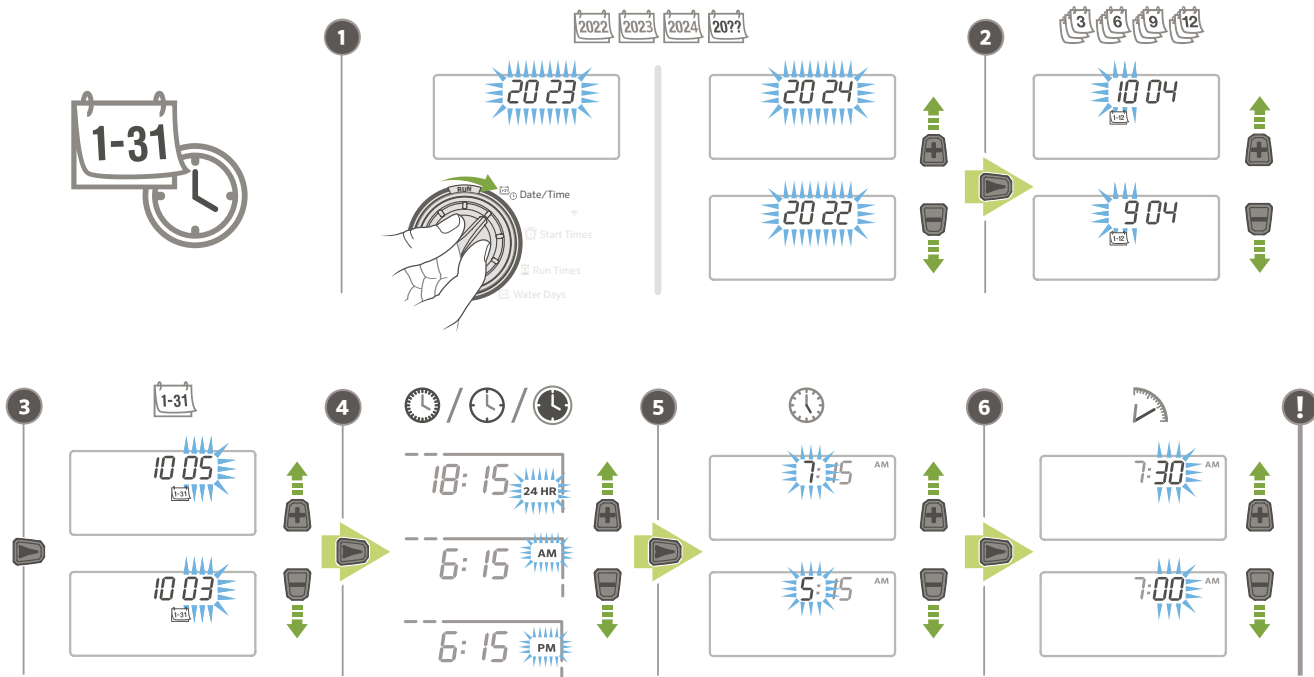

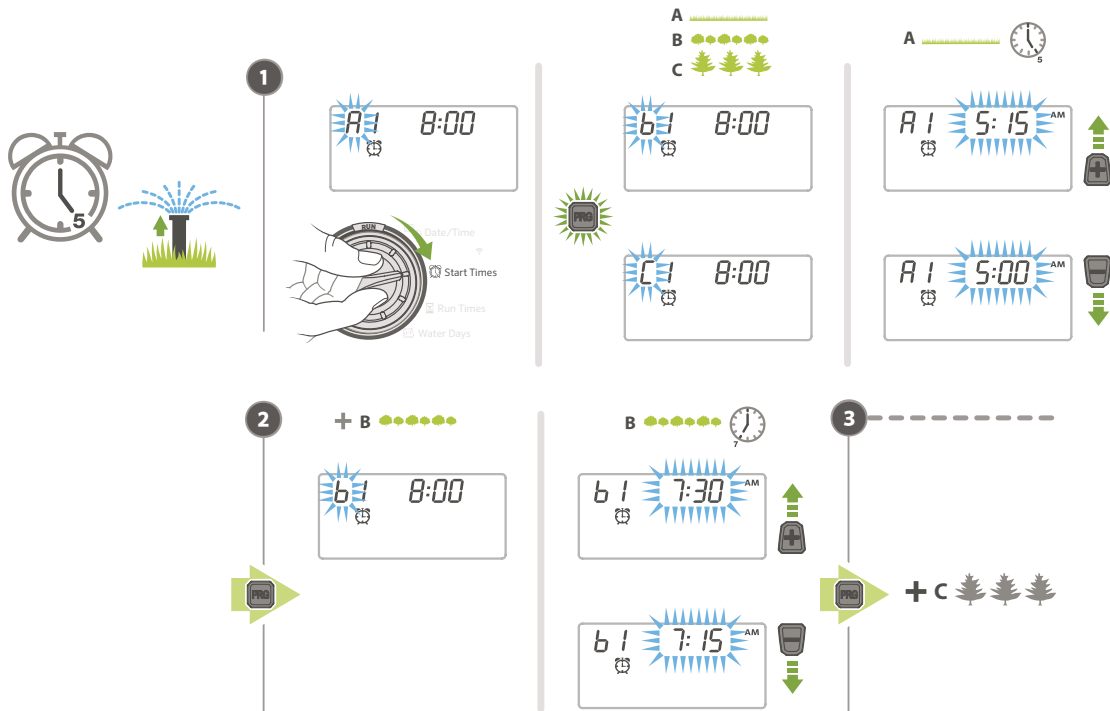

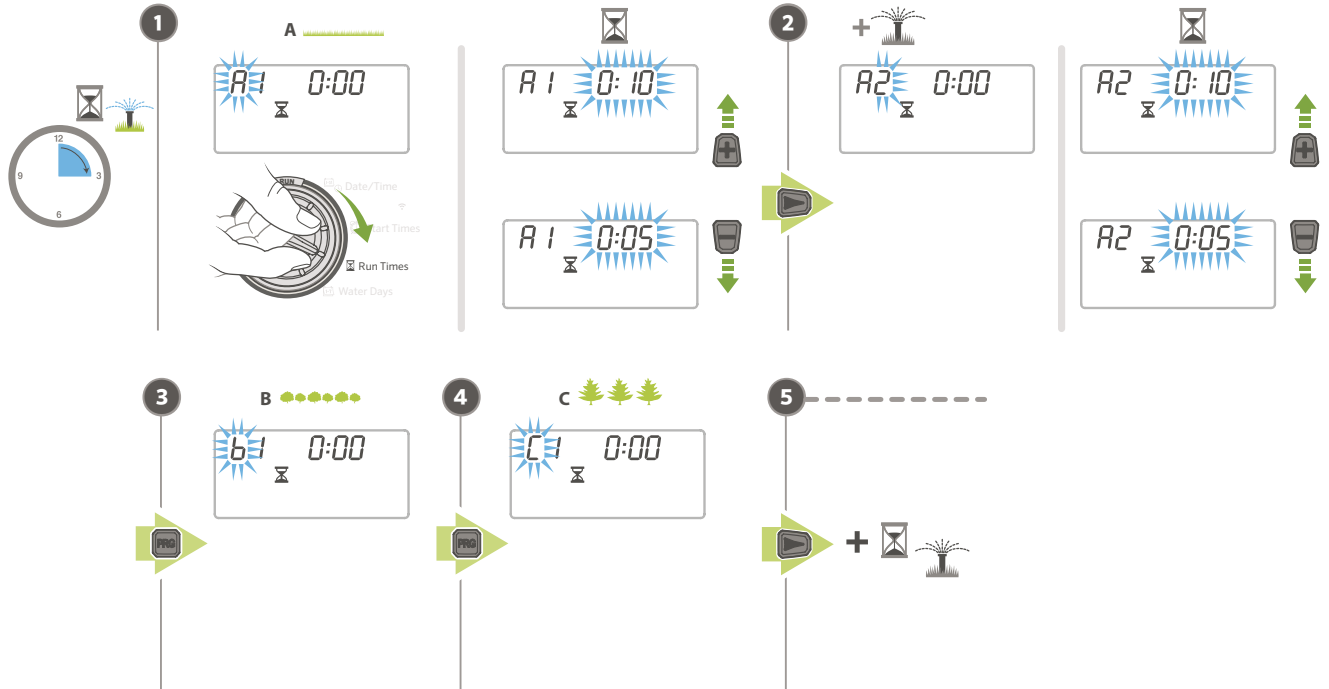

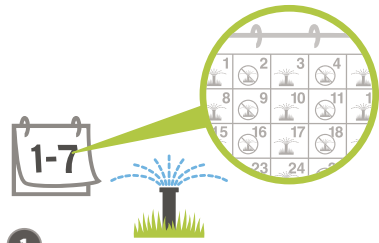

1

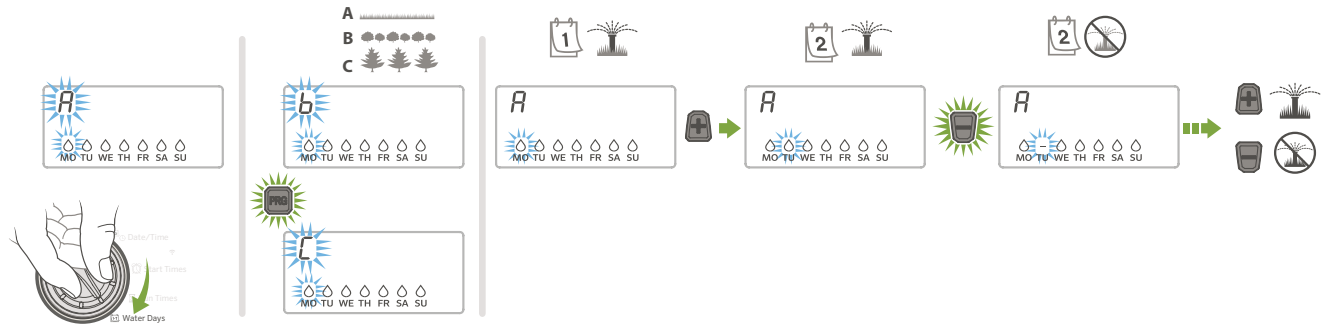

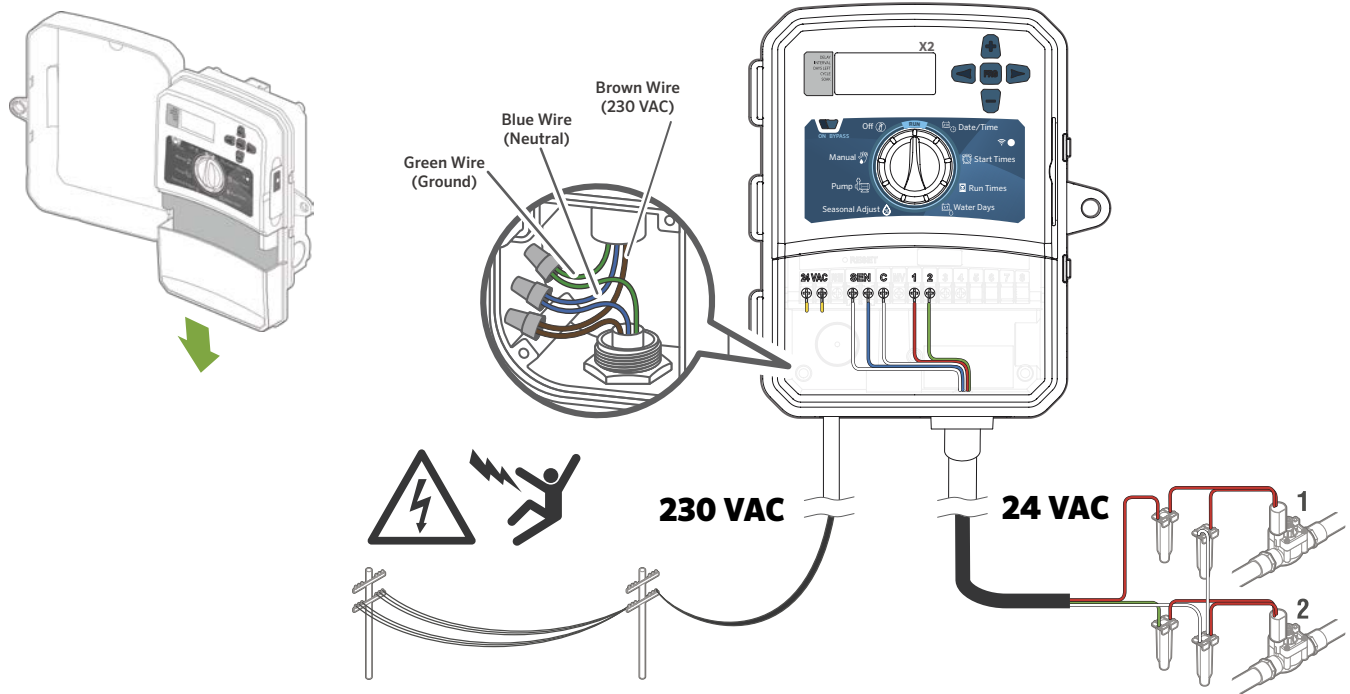

WAND FOR X2

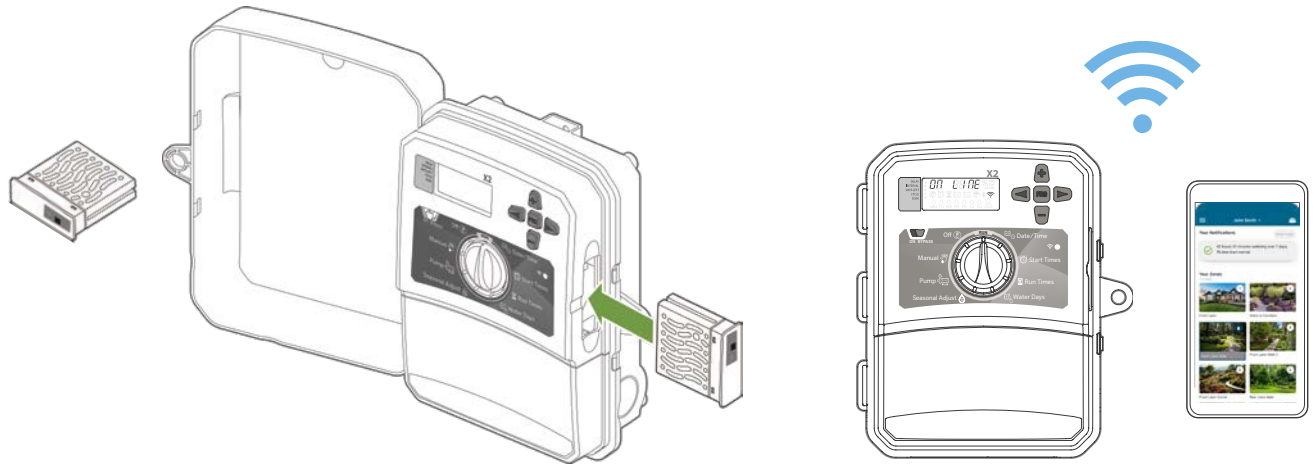

NOTES

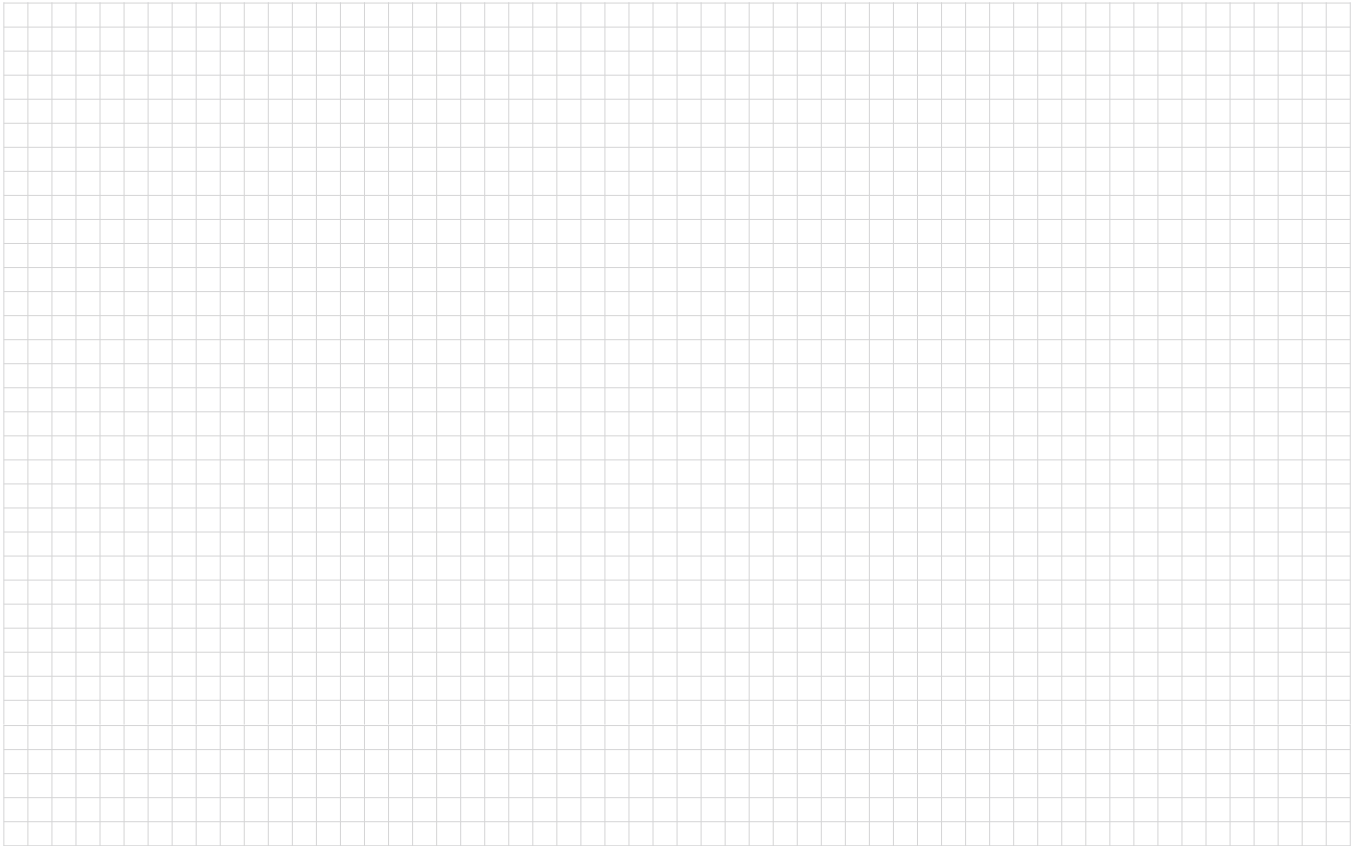

NOTES



The Hunter logo is displayed in a bold, white, sans-serif font. The letter 'H' is significantly larger than the other letters, and the 'er' is smaller and positioned to the right of the 'H'. A registered trademark symbol (®) is located at the top right of the 'er'.

hunterindustries.com | 1940 Diamond Street, San Marcos, California 92078 USA

© 2024 Hunter Industries Inc. Hunter, the Hunter logo, and other marks are trademarks of Hunter Industries Inc., registered in the U.S. and certain other countries. Please recycle. ♻️

RC-210 F 7/24