

Product Catalog

RESIDENTIAL & COMMERCIAL IRRIGATION | *Built on Innovation®*

VOLUME 40

Hunter®



Table of CONTENTS

INTRODUCTION

- 4 Partnering for Success
- 6 Advancing the Industry Through Innovation

ROTORS

- 12 PGJ
- 13 SRM
- 14 PGP-ADJ
- 16 PGP® Ultra
- 17 I-20
- 18 PGP Ultra PRB
- 18 I-20 PRB
- 22 I-25
- 24 I-40
- 26 I-80
- 28 I-90
- 30 HSJ Swing Joints
- 30 HCV Check Valves
- 31 SnapLok™ Combo Kits

ST SYSTEMS

- 33 ST-90
- 33 High-Flow Swing Joints
- 34 ST-1200-BR
- 35 ST-1600-HS-BR
- 36 ST-1600-KIT/ST-1600-HS-B
- 38 STG-900-KIT/STG-900

MP ROTATOR®

- 42 Standard MP Rotator Nozzles
- 46 MP Rotator MP800 Nozzles
- 48 MP Rotator Stake Kit

SPRAY SPRINKLER BODIES

- 54 PS Ultra
- 57 Pro-Spray®
- 58 Pro-Spray PRS30 **NEW**
- 60 Pro-Spray PRS40 **NEW**

SPRAY ACCESSORIES

- 62 SJ Swing Joints
- 62 Hunter Spiral Barb Elbows
- 62 FlexSG Tubing
- 62 Pro-Spray Shutoff Cap
- 62 Shutoff Nozzle

NOZZLES

- 64 Pro High-Efficiency Nozzles **NEW**
- 66 Pro Adjustable Nozzles
- 69 Pro Fixed Nozzles
- 72 Short-Radius Micro Spray Nozzles
- 73 Strip Pattern Nozzles
- 74 Bubbler Nozzles
- 75 Bubblers

VALVES

- 78 1" PGV & PGV Jar-Top
- 80 PGV-ASV
- 81 1½" and 2" PGV
- 82 ICV
- 84 IBV
- 85 Accu Sync® Pressure Regulator
- 86 Quick Couplers
- 88 DC-Latching Solenoid
- 88 AC Solenoid

CONTROLLERS

- 92 Controller Selection Guide

STANDARD CONTROLLERS

- 95 X-Core®

HYDRAWISE® CONTROLLERS

- 98 Hydrawise Software
- 100 X2™
- 101 WAND for X2
- 102 Pro-HC
- 103 HPC
- 104 HCC
- 105 Wi-Fi System Overview

CENTRALUS™ CONTROLLERS

- 108 Centralus Software
- 110 ACC2
- 111 ACC2 Decoder
- 112 ICC2
- 113 Pro-C® **NEW**
- 114 Hunter Field Servers **NEW**

BATTERY-OPERATED CONTROLLERS

- 117 BTT
- 118 NODE
- 119 NODE-BT **NEW**
- 120 XC Hybrid

CONTROLLER DECODERS AND ACCESSORIES

- 122 Wireless Valve Link **NEW**
- 124 ICD
- 125 ICD-HP Programmer
- 126 EZ Decoder System
- 127 EZ-DT
- 128 Universal Decoder Stake
- 128 Antenna Extension Kits
- 129 Waterproof Wire Connector
- 129 Waterproof Splice Kit
- 130 ROAM Remote
- 131 ROAM XL Remote
- 132 Pump Start Relay (PSR)
- 132 Pump Start Relay Booster (PSR-B)
- 133 Controller Communication Devices **NEW**

SENSORS

- 138 Rain-Clik®
- 139 Mini-Clik® **NEW**
- 140 Solar Sync®
- 141 Soil-Clik®
- 142 HC Flow Meter
- 144 Flow-Clik®
- 145 Flow-Sync®
- 146 Wireless Flow Sensor (WFS)

MICRO

149 Micro Irrigation Solutions

CONTROL ZONE KITS

151 PCZ
151 ACZ
152 1" ICZ
153 1½" and 2" ICZ
154 1" IBZ
155 1½" and 2" IBZ
156 Filter Regulators
157 Filters
158 Senninger® Pressure Regulators

DRIPLINE SYSTEMS

160 HDL-CV
161 HDL-PC
161 HDL-R
162 HDL-BLNK
163 HDL-COP **NEW**
164 PLD LOC Fittings
164 PLD Barb Fittings

SUBSURFACE SYSTEMS

166 Eco-Mat®
167 Eco-Wrap®
168 Eco-Indicator **NEW**
169 Supply Tubing
169 MLD
170 Distribution Tubing
170 ¼" Barbed Fittings
171 RZWS

SOFT & HARD PIPE SYSTEMS

174 Point-Source Emitters
175 IH Risers
176 Multi-Port Emitters
177 Micro Sprays
177 Rigid Risers
178 Multi-Purpose Box
179 Air/Vacuum Relief Valve
179 Automatic Flush Valve

RECLAIMED

182 Rotors/Sprinkler Bodies
183 Bubblers/Valves/Micro **NEW**

TOOLS

185 SpotShot Hose-End Nozzle
185 Pitot Gauge
185 MP Gauge Assembly
185 Hand Pump
185 Nozzle Insertion Collar
185 Hunter Wrench
185 T-Handle Tool
185 Nozzle Removal/Installation Tool
185 Snap Ring Removal Tool

RESOURCES

187 Hunter University
188 Education, Tools, and Support
for Professionals

TECHNICAL INFORMATION

190 Precipitation Rates
191 Slope Equivalents/Irrigation
192 Height of Spray Chart
194 MLD Flow Chart **NEW**
194 HDL Maximum Run Lengths **NEW**
195 Conversion Factors Chart
196 Friction Loss Charts
205 Accessory Pressure Loss Charts
206 BTT Pressure Loss Charts
206 HY Filter Pressure Loss Chart
207 Wire Data Chart
207 PSR Wire Data Chart
208 Wire Sizing
209 Solar Sync Calibration Table
209 Additional Data

STATEMENT OF WARRANTY

210 Statement of Warranty

PARTNERING FOR SUCCESS

Helping You Grow Is Our Mission

At Hunter Industries, our main objective is to deliver the irrigation solutions you need most to grow your business. We're grateful to you, our customers, for your partnership and trust over the past four decades. Your support continues to drive our passion for providing industry-leading products, comprehensive educational programs, and exceptional customer service.

Recent investments in our manufacturing operations have allowed us to expand our production capacities and launch innovative new products that deliver high-level performance, increased water and energy savings, and greater system flexibility — all of which strengthen your business.

Educating your team on our products and industry best practices is key to our mutual success. We've launched many new online courses focusing on irrigation system fundamentals, added time-saving tools to our free business applications, and updated our state-of-the-art customer training center at our corporate headquarters to engage with industry professionals through popular hands-on workshops.

Along with products and education, we continue to invest in the latest technologies that enable us to respond to your needs as quickly as possible. Our world-class customer support and technical support teams are ready to help you the moment you need it.

We're proud to be your partner, and we thank you for choosing Hunter Industries.





ADVANCING THE INDUSTRY

Through Innovation



Everything we do at Hunter Industries is rooted in innovation. From small residential installations to fully automated smart cities, our teams continually develop solutions to help you deliver water as efficiently and sustainably as possible.

That's why we're excited to introduce the latest additions to our cutting-edge lineup: the new Wireless Valve Link (page 122), revolutionary Pro High-Efficiency Nozzles (page 64), and the updated Pro-C® Controller (page 113).

As we continue to explore new ways to innovate, you can expect us to deliver even more industry-leading products, services, and tools in the future to help your business grow.



Leading the Way Toward Greater Sustainability

As the industry's sustainability leader, we're committed to supporting and improving the communities where we live, work, and play.

We develop products and technologies that enable the efficient use of our natural resources and reduce our environmental footprint.

We believe in the triple bottom line, which focuses on People, Planet, and Profit.

Scan to learn more about our commitment to sustainability!



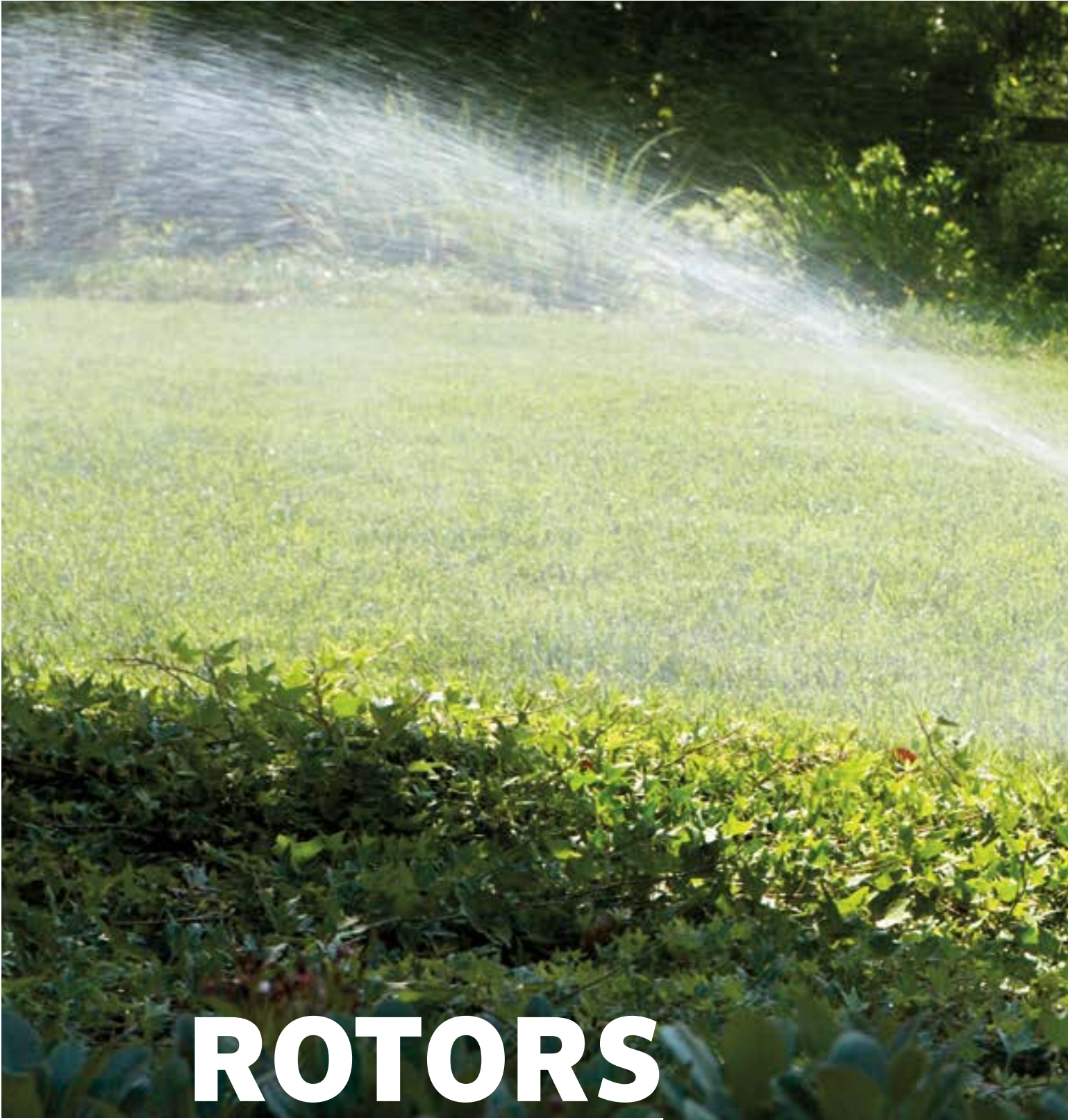

ROTORS



ROTORS

ADVANCED FEATURES

RELIABLE STRENGTH & DURABILITY

PRESSURE-REGULATED BODY



Reduce high incoming pressure to prevent misting and allow nozzles to operate at peak efficiency. Lower pressure produces larger water droplets that fight the effects of wind.

PGP® Ultra Shrub and 4", I-20 Shrub, 4" and 6"

STAINLESS STEEL RISER



For unforgiving soil conditions, unpredictable climates, or heavy foot traffic, stainless steel is the best choice.

Standard on I-40, I-80
Optional on I-20 and I-25

DRAIN CHECK VALVE



The Drain Check Valve keeps lines from draining when the system is shut off. This saves water, reduces liability, and prolongs system life.

PGJ, PGP Ultra, I-20, I-25, I-40, I-80, I-90

VALUE-ADDED OPTIONS

OPPOSING NOZZLE 360° MODEL



The opposing nozzle design offers excellent water distribution. With primary and secondary nozzles on opposing sides of the turret, streams arc in opposite directions as the sprinkler rotates for outstanding midrange and close-in watering.

I-40, I-80, I-90

EASY IN-THE-FIELD IDENTIFICATION

OPTIONAL RECLAIMED WATER ID



Purple caps indicate where non-potable irrigation water is being used.

PGJ, PGP Ultra, I-20, I-25, I-40, I-80, I-90

COLOR-CODED NOZZLES



Nozzles are easier to differentiate in the field for simple installation and quick organization.

I-25, I-40, I-80, I-90

EASY AS-NEEDED ADJUSTMENTS

AUTOMATIC ARC RETURN & NON-STRIPPABLE DRIVE

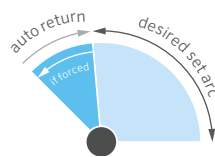

This patented feature returns the turret to the original arc regardless of where it is turned. The non-strippable drive mechanism is protected from damage, ensuring protection from vandalism.

PGP Ultra, I-20, I-25, I-40

FLOSTOP® CONTROL



FloStop® Technology stops the flow of water from individual sprinkler heads while the system is running. This is ideal for changing nozzles or turning off specific heads during maintenance and construction.

I-20

HEADED AND SLOTTED SETSCREW



Use a slotted screwdriver or the Hunter Wrench for easier and simpler adjustments as needed.

PGJ, PGP Ultra, I-20

ROTOR COMPARISON CHART

QUICK SPECS		PGJ	SRM	PGP-ADJ	PGP ULTRA	I-20	I-25	I-40	I-40-ON	I-80	I-90
INLET SIZE		½"	½"	¾"	¾"	¾"	1"	1"	1"	1½"	1½"
RADIUS	ft.	15' - 37'	15' - 30'	22' - 52'	17' - 46'	17' - 46'	40' - 71'	44' - 69'	52' - 76'	63' - 97'	66' - 103'
FLOW	GPM	0.64 - 5.3	0.42 - 3.4	0.5 - 14.1	0.36 - 14.8	0.36 - 14.8	3.8 - 31.5	7.6 - 29.5	13.0 - 33.7	20.2-58.5	29.5 - 83.8
FEATURES											
RECOMMENDED PRESSURE RANGE	PSI	30 - 50	30 - 50	25 - 70	25 - 70	25 - 70	40 - 100	40 - 100	40 - 100	50-100	80 - 120
OPERATING PRESSURE RANGE	PSI	20 - 100	20 - 100	20 - 100	20 - 100	20 - 100	40 - 100	40 - 100	40 - 100	50 - 100	80 - 120
NOZZLE TRAJECTORY		15°	15°	25°	25°	25°	25°	25°	25°	22.5°	22.5°
SPECIFIC NOZZLES		---	---	---	Optional	Optional	Pre-Installed	Pre-Installed	Pre-Installed	Pre-Installed	Pre-Installed
NOZZLE OPTIONS		8	6	27	34	34	11	6	6	7	8
WARRANTY		2 Years	1 Year	2 Years	5 Years	5 Years	5 Years	5 Years	5 Years	5 Years	5 Years
ADVANCED FEATURES											
LOW-ANGLE NOZZLE CHOICES				●	●	●					
AUTOMATIC ARC RETURN					●	●	●	●			
NON-STRIPPABLE DRIVE					●	●	●	●			
PART- AND FULL-CIRCLE IN ONE MODEL					●	●	●	●		●	
HEADED AND SLOTTED SETSCREW		●			●	●					
RECLAIMED WATER ID		●			●	●	●	●	●	●	●
AVAILABLE SHORT RADIUS NOZZLES					●	●					
FLOSTOP® CONTROL						●					
OPPOSING NOZZLE									●	●	●
STAINLESS STEEL RISER OPTION						●	●	●	●	●	
OPTIONAL PRESSURE-REGULATED BODY					●	●					
OPTIONAL OR FACTORY-INSTALLED DRAIN CHECK VALVE		● (7')			● (7')	● (7')	● (10')	● (15')	● (15')	● (5')	● (9')

PGJ

Radius: **15' to 34'**
Flow: **0.42 to 4.3 GPM**

The highly durable PGJ offers all the benefits of a large rotor in a compact, spray-sized package, with water-efficient nozzles and easy arc adjustment.

KEY BENEFITS

- Headed and slotted setscrew allows radius adjustment with a Hunter Wrench or flat-blade screwdriver
- Adjustable arc from 40° to 360° to keep water in the appropriate areas
- Standard factory-installed 2.0 nozzle speeds installation
- QuickCheck™ Arc Mechanism for fast arc adjustment

OPERATING SPECIFICATIONS

- Nozzle choices: 8
- Radius: 15' to 34'
- Flow: 0.42 to 4.3 GPM
- Recommended pressure range: 30 to 50 PSI
- Operating pressure range: 20 to 100 PSI
- Precipitation rate: 0.6 in/hr approximately
- Nozzle trajectory: 14° approximately
- Warranty period: 2 years

FACTORY-INSTALLED OPTIONS

- Drain Check Valve (up to 7' of elevation) excluding PGJ-00
- Reclaimed water ID

USER-INSTALLED OPTIONS

- Drain Check Valve (up to 7' of elevation) excluding PGJ-00 (P/N 462078SP)
- HC-50F-50M Check Valve (up to 32' of elevation)



PGJ Reclaimed

Available as a factory-installed option on all models

PGJ - SPECIFICATION BUILDER: ORDER 1 + 2 + 3

1 Model	2 Standard Features	3 Feature Options
PGJ-00 = Shrub	Adjustable arc, 8 standard nozzles	(blank) = No option
PGJ-04 = 4" pop-up		V = Drain Check Valve
PGJ-06 = 6" pop-up		R = Drain Check Valve and reclaimed water ID
PGJ-12 = 12" pop-up		

Examples:

- PGJ-04 = 4" pop-up, adjustable arc
- PGJ-06-V = 6" pop-up, adjustable arc, with drain Check Valve
- PGJ-12-R = 12" pop-up, adjustable arc, with drain Check Valve and reclaimed water ID

Compatible with:



1/2" Swing Joints
Page 62



Hunter FlexSG
Page 62



PGJ-00

Overall height: 7"
Exposed diameter: 1 1/8"
Inlet size: 1/2"



PGJ-04

Overall height: 7 1/8"
Pop-up height: 4"
Exposed diameter: 1 1/8"
Inlet size: 1/2"



PGJ-06

Overall height: 9 1/8"
Pop-up height: 6"
Exposed diameter: 1 1/8"
Inlet size: 1/2"



PGJ-12

Overall height: 16 3/8"
Pop-up height: 12"
Exposed diameter: 1 1/8"
Inlet size: 1/2"

PGJ PERFORMANCE DATA					PGJ NOZZLES	
Nozzle	Pressure PSI	Radius ft.	Flow GPM	Precip in/hr		
				■	▲	
0.50	30	14	0.42	0.41	0.48	
	40	15	0.50	0.43	0.49	
	50	16	0.58	0.44	0.50	
0.75	30	15	0.64	0.55	0.63	
	40	16	0.75	0.56	0.65	
	50	17	0.85	0.57	0.65	
1.0	30	18	0.85	0.51	0.58	
	40	19	1.0	0.51	0.59	
	50	19	1.1	0.57	0.66	
1.5	30	21	1.3	0.57	0.66	
	40	22	1.5	0.60	0.69	
	50	22	1.7	0.67	0.77	
2.0	30	24	1.7	0.55	0.64	
	40	25	2.0	0.62	0.71	
	50	25	2.3	0.71	0.82	
2.5	30	27	2.2	0.58	0.67	
	40	28	2.5	0.60	0.69	
	50	28	2.8	0.68	0.79	
3.0	30	30	2.5	0.53	0.62	
	40	31	3.0	0.60	0.69	
	50	31	3.4	0.68	0.79	
4.0	30	33	3.7	0.65	0.76	
	40	33	4.0	0.71	0.82	
	50	34	4.3	0.72	0.83	

Note:

All precipitation rates calculated for 180° operation. For the precipitation rate for a 360° sprinkler, divide by 2.

SRM

The SRM is an economical short-range rotor that offers a convenient and efficient alternative to spray heads.

KEY BENEFITS

- Adjustable arc from 40° to 360° to keep water in the appropriate areas
- Standard factory-installed 2.0 nozzle speeds installation
- Through-the-top arc adjustment for easy installation
- QuickCheck™ Arc Mechanism for fast arc adjustment

OPERATING SPECIFICATIONS

- Nozzle choices: 8
- Radius: 15' to 34'
- Flow: 0.42 to 4.3 GPM
- Recommended pressure range: 30 to 50 PSI
- Operating pressure range: 20 to 100 PSI
- Precipitation rate: 0.6 in/hr approximately
- Nozzle trajectory: 14° approximately
- Warranty period: 1 year

USER-INSTALLED OPTIONS

- Drain Check Valve (up to 7' of elevation) (P/N 462078SP)

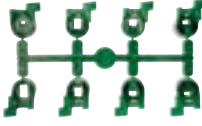
SRM		SRM NOZZLES
Model	Description	
SRM-04	4" pop-up, adjustable arc, 8 standard nozzles	

SRM



Radius: **15' to 34'**
Flow: **0.42 to 4.3 GPM**



SRM-04

Overall height: 7 $\frac{1}{2}$ "
Pop-up height: 4"
Exposed diameter: 1 $\frac{1}{8}$ "
Inlet size: $\frac{1}{2}$ "

SRM-04 PERFORMANCE DATA

Nozzle	Pressure PSI	Radius ft.	Flow GPM	Precip in/hr	
				■	▲
0.50	30	14	0.42	0.41	0.48
	40	15	0.50	0.43	0.49
	50	16	0.58	0.44	0.50
0.75	30	15	0.64	0.55	0.63
	40	16	0.75	0.56	0.65
	50	17	0.85	0.57	0.65
1.0	30	18	0.85	0.51	0.58
	40	19	1.0	0.51	0.59
	50	19	1.1	0.57	0.66
1.5	30	21	1.3	0.57	0.66
	40	22	1.5	0.60	0.69
	50	22	1.7	0.67	0.77
2.0	30	24	1.7	0.55	0.64
	40	25	2.0	0.62	0.71
	50	25	2.3	0.71	0.82
2.5	30	27	2.2	0.58	0.67
	40	28	2.5	0.60	0.69
	50	28	2.8	0.68	0.79
3.0	30	30	2.5	0.53	0.62
	40	31	3.0	0.60	0.69
	50	31	3.4	0.68	0.79
4.0	30	33	3.7	0.65	0.76
	40	33	4.0	0.71	0.82
	50	34	4.3	0.72	0.83

Note:

All precipitation rates calculated for 180° operation. For the precipitation rate for a 360° sprinkler, divide by 2.

Compatible with:



1/2" Swing Joints
Page 62

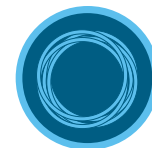

Hunter FlexSG
Page 62

PGP-ADJ

Radius: **22' to 52'**
Flow: **0.5 to 14.1 GPM**

As Hunter's original rotor, the PGP-ADJ delivers unsurpassed reliability, durability, versatility, and value, keeping it the professional's choice year after year.

KEY BENEFITS

- Three types of nozzles available for various landscapes: red standard, blue standard, gray low-angle
- Adjustable arc from 40° to 360° to keep water in the appropriate areas
- Factory-installed rubber cover for safety
- Through-the-top arc adjustment for easy installation
- QuickCheck™ Arc Mechanism for fast arc adjustment

OPERATING SPECIFICATIONS

- Nozzle choices: 27
- Radius: 22' to 52'
- Flow: 0.5 to 14.1 GPM
- Recommended pressure range: 25 to 70 PSI
- Operating pressure range: 20 to 100 PSI
- Precipitation rate: 0.4 in/hr approximately
- Nozzle trajectory: standard = 25°, low-angle = 13°
- Warranty period: 2 years

FACTORY-INSTALLED OPTIONS

- Red 5 to 8 Nozzles, Blue 1.5 to 4.0 Nozzles

USER-INSTALLED OPTIONS

- Drain Check Valve (up to 3' of elevation) (P/N 142300SP)

PGP-ADJ - SPECIFICATION BUILDER: ORDER 1 + 2 + 3		
1 Model	2 Standard Features	3 Feature Options
PGP-ADJ-B = 4" pop-up	Adjustable arc with blue nozzle rack	1.5 to 4.0 = Factory-installed blue nozzle number
PGP-ADJ = 4" pop-up	Adjustable arc with red nozzle rack	5 to 8 = Factory-installed red nozzle number

Examples:

PGP-ADJ = 4" pop-up, adjustable arc

PGP-ADJ-B-3.0 = 4" pop-up, adjustable arc, and Blue 3.0 Nozzle

PGP-ADJ-07 = 4" pop-up, adjustable arc, and Red 7 Nozzle

PGP-ADJ Red Nozzle



PGP-ADJ

Overall height: 7³/₈"

Pop-up height: 4"

Exposed diameter: 1³/₄"

Inlet size: ³/₄"

PGP-ADJ GRAY LOW-ANGLE NOZZLE PERFORMANCE DATA

Nozzle	Pressure PSI	Radius ft.	Flow GPM	Precip in/hr	
				■	▲
4LA ●	30	22	1.4	0.56	0.64
	40	24	1.7	0.57	0.66
	Gray 50	26	1.8	0.51	0.59
	60	28	2.0	0.49	0.57
5LA ●	30	25	1.6	0.49	0.57
	40	27	1.9	0.50	0.58
	Gray 50	28	2.1	0.52	0.60
	60	30	2.3	0.49	0.57
6LA ●	30	27	2.1	0.55	0.64
	40	30	2.5	0.53	0.62
	Gray 50	33	2.8	0.49	0.57
	60	35	3.0	0.47	0.54
7LA ●	30	29	2.8	0.64	0.74
	40	32	3.1	0.58	0.67
	Gray 50	35	3.5	0.55	0.64
	60	37	3.8	0.53	0.62
8LA ●	30	31	3.4	0.68	0.79
	40	34	3.9	0.65	0.75
	Gray 50	37	4.4	0.62	0.71
	60	38	4.7	0.63	0.72
9LA ●	30	33	4.3	0.76	0.88
	40	37	5.0	0.70	0.81
	Gray 50	40	5.6	0.67	0.78
	60	42	6.1	0.67	0.77
10LA ●	40	38	6.5	0.87	1.00
	50	40	7.3	0.88	1.01
	Gray 60	42	8.0	0.87	1.01
	70	44	8.6	0.86	0.99

Bold = Recommended pressure

Note:

All precipitation rates calculated for 180° operation. For the precipitation rate for a 360° sprinkler, divide by 2.

PGP-ADJ RED NOZZLE PERFORMANCE DATA					
Nozzle	Pressure PSI	Radius ft.	Flow GPM	Precip in/hr	
				■	▲
1 Red	30	28	0.5	0.12	0.14
	40	29	0.6	0.14	0.16
	50	29	0.7	0.16	0.19
	60	30	0.8	0.17	0.20
2 Red	30	29	0.7	0.16	0.19
	40	30	0.8	0.17	0.20
	50	30	0.9	0.19	0.22
3 Red	30	30	0.9	0.19	0.22
	40	31	1.0	0.20	0.23
	50	31	1.2	0.24	0.28
4 Red	30	32	1.2	0.23	0.26
	40	33	1.4	0.25	0.29
	50	34	1.6	0.27	0.31
5 Red	30	32	1.6	0.30	0.35
	40	36	1.8	0.27	0.31
	50	38	2.0	0.27	0.31
6 Red	30	34	2.0	0.33	0.38
	40	36	2.4	0.36	0.41
	50	38	2.7	0.36	0.42
7 Red	30	34	2.6	0.43	0.50
	40	38	3.0	0.40	0.46
	50	40	3.4	0.41	0.47
8 Red	30	37	3.2	0.45	0.52
	40	39	3.7	0.47	0.54
	50	41	3.9	0.45	0.52
9 Red	30	38	3.6	0.48	0.55
	40	41	4.3	0.49	0.57
	50	44	5.2	0.52	0.60
10 Red	30	40	4.0	0.52	0.60
	40	44	6.0	0.60	0.69
	50	46	6.8	0.62	0.71
	60	47	7.6	0.66	0.76
11 Red	40	46	8.0	0.66	0.76
	50	48	8.9	0.74	0.86
	60	50	9.8	0.75	0.87
12 Red	70	51	10.5	0.78	0.90
	40	46	10.5	0.96	1.10
	50	48	11.9	0.99	1.15
	60	50	12.7	0.98	1.13
70	52	14.1	1.00	1.16	

Bold = Recommended pressure

Note:

All precipitation rates calculated for 180° operation. For the precipitation rate for a 360° sprinkler, divide by 2.

PGP-ADJ BLUE NOZZLE PERFORMANCE DATA					
Nozzle	Pressure PSI	Radius ft.	Flow GPM	Precip in/hr	
				■	▲
1.5 Blue	25	29	1.2	0.27	0.32
	35	31	1.4	0.28	0.32
	45	31	1.5	0.30	0.35
	55	32	1.8	0.34	0.39
2.0 Blue	65	32	1.9	0.36	0.41
	25	33	1.4	0.25	0.29
	35	33	1.7	0.30	0.35
2.5 Blue	45	34	2.0	0.33	0.38
	55	34	2.1	0.35	0.40
	65	34	2.3	0.43	0.50
3.0 Blue	25	33	1.7	0.30	0.35
	35	35	2.1	0.33	0.38
	45	35	2.5	0.39	0.45
3.0 Blue	55	35	2.6	0.41	0.47
	65	35	2.9	0.46	0.53
	25	35	2.2	0.35	0.40
4.0 Blue	35	36	2.7	0.40	0.46
	45	38	3.0	0.40	0.46
	55	39	3.4	0.43	0.50
4.0 Blue	65	39	3.7	0.47	0.54
	25	37	3.0	0.42	0.49
	35	39	3.5	0.44	0.51
5.0 Blue	45	40	4.0	0.48	0.56
	55	41	4.5	0.52	0.60
	65	41	4.8	0.55	0.63
5.0 Blue	25	37	3.7	0.52	0.60
	35	39	4.5	0.57	0.66
	45	42	5.0	0.55	0.63
6.0 Blue	55	42	5.7	0.62	0.72
	65	42	6.2	0.68	0.78
	25	38	4.3	0.57	0.66
6.0 Blue	35	40	5.6	0.67	0.78
	45	43	6.0	0.62	0.72
	55	44	6.7	0.67	0.77
8.0 Blue	65	44	7.3	0.73	0.84
	25	37	6.0	0.84	0.97
	35	41	7.0	0.80	0.93
8.0 Blue	45	44	8.0	0.80	0.92
	55	46	9.0	0.82	0.95
	65	46	9.8	0.89	1.03

PGP NOZZLES



Red (P/N 130900)



Blue (P/N 665300)



Gray (P/N 233200)



PGP-ADJ

Easy arc and radius adjustment

PGP® ULTRA

Radius: **17' to 46'**
Flow: **0.36 to 14.8 GPM**

The PGP Ultra raises the bar for rotor technology with powerful features developed over three decades of research, customer feedback, and lab testing.

ROTORS

KEY BENEFITS

- Patented automatic arc return feature returns the turret back to the original arc pattern if vandalized; adjustable arc from 50° to 360°
- Non-strippable drive mechanism is protected from damage if turned in the opposite direction of travel
- Part- and full-circle in one model for flexibility across landscapes and reduced inventory
- Headed and slotted setscrew allows radius adjustment with a Hunter Wrench or flat-blade screwdriver
- Flat-top nozzles allow fast, easy insertion
- QuickCheck™ Arc Mechanism for fast arc adjustment

OPERATING SPECIFICATIONS

- Nozzle choices: 34
- Radius: 17' to 46'
- Flow: 0.36 to 14.8 GPM
- Recommended pressure range: 25 to 70 PSI
- Operating pressure range: 20 to 100 PSI
- Precipitation rate: 0.4 in/hr approximately
- Nozzle trajectory: standard = 25°, low-angle = 13°
- Nozzle racks: Blue 1.5 to 8.0, Gray Low-Angle 2.0 to 4.5, Black 0.50 to 3.0, Green 6.0 to 13.0, MPR-25, MPR-30, MPR-35
- Warranty period: 5 years

FACTORY-INSTALLED OPTIONS

- Drain Check Valve (up to 10' of elevation)
- Reclaimed water ID
- Blue 1.5 to 4.0 Nozzles

USER-INSTALLED OPTIONS

- Drain Check Valve (up to 3' of elevation) PGP 4" / 6" only (P/N 142300SP)
- HSJ-0 prefabricated ¾" PVC Swing Joint



PGP Ultra Reclaimed

Available as a factory-installed option on all models



PGP Ultra

Easy arc and radius adjustment



PGP-00

Overall height: 7½"
Exposed diameter: 1¾"
Inlet size: ¾"



PGP-04

Overall height: 7½"
Pop-up height: 4"
Exposed diameter: 1¾"
Inlet size: ¾"



PGP-06

Overall height: 9⅞"
Pop-up height: 6"
Exposed diameter: 1¾"
Inlet size: ¾"



PGP-12

Overall height: 17"
Pop-up height: 12"
Exposed diameter: 1¾"
Inlet size: ¾"

PGP-ULTRA – SPECIFICATION BUILDER: ORDER 1 + 2 + 3 + 4

1 Model	2 Standard Features	3 Feature Options	4 Nozzle Options
PGP-00 = Shrub PGP-04 = 4" pop-up PGP-06 = 6" pop-up PGP-12 = 12" pop-up	Adjustable arc, plastic riser, 8 standard nozzles, and 4 low-angle nozzles	(blank) = No option CV = Drain Check Valve CV-R = Drain Check Valve and reclaimed water ID	Blue 1.5 to 8.0 Gray low-angle Black short-radius Green high-flow MPR-25-Q, T, H, F MPR-30-Q, T, H, F MPR-35-Q, T, H, F 1.5 to 4.0 = Only nozzles 1.5 to 4.0 can be factory-installed

Examples:

PGP-04 = 4" pop-up, adjustable arc

PGP-04-2.5 = 4" pop-up, adjustable arc, and 2.5 nozzle

PGP-12-CV-R-4.0 = 12" pop-up, adjustable arc, with drain check valve and reclaimed water ID, and 4.0 nozzle

I-20

Radius: **17' to 46'**
Flow: **0.36 to 14.8 GPM**

The I-20 is loaded with upgraded features such as FloStop® Technology, check valves, and efficient nozzles that make it the perfect choice in a range of applications.

KEY BENEFITS

- Patented automatic arc return feature returns the turret back to the original arc pattern if vandalized; adjustable arc from 50° to 360°
- Non-strippable drive mechanism is protected from damage if turned in the opposite direction of travel
- Part- and full-circle in one model for flexibility across landscapes and reduced inventory
- Headed and slotted setscrew allows radius adjustment with a Hunter Wrench or flat-blade screwdriver
- FloStop Technology stops the flow of water from individual sprinklers to change the nozzle or perform repairs
- Flat-top nozzles allow fast, easy insertion
- QuickCheck™ Arc Mechanism for fast arc adjustment
- Available stainless steel riser for extra durability
- Drain Check Valve prevents low-head drainage (up to 10' of elevation)

OPERATING SPECIFICATIONS

- Nozzle choices: 34
- Radius: 17' to 46'
- Flow: 0.36 to 14.8 GPM
- Recommended pressure range: 25 to 70 PSI
- Operating pressure range: 20 to 100 PSI
- Precipitation rate: 0.4 in/hr approximately
- Nozzle trajectory: standard = 25°, low-angle = 13°
- Nozzle racks: Blue 1.5 to 8.0, Gray Low-Angle 2.0 to 4.5, Black 0.50 to 3.0, Green 6.0 to 13.0, MPR-25, MPR-30, MPR-35
- Warranty period: 5 years

FACTORY-INSTALLED OPTIONS

- No drain Check Valve (NCV models)
- Reclaimed water ID
- Blue 1.5 to 4.0 Nozzles

USER-INSTALLED OPTIONS

- HSJ-0 prefabricated ¾" PVC Swing Joint

I-20 (PLASTIC) – SPECIFICATION BUILDER: ORDER 1 + 2 + 3 + 4

1 Model	2 Standard Features	3 Feature Options	4 Nozzle Options
I-20-00 = Shrub I-20-04 = 4" pop-up I-20-06 = 6" pop-up I-20-12 = 12" pop-up	Adjustable arc, plastic riser, check valve, 8 standard nozzles, and 4 low-angle nozzles	(blank) = No option NCV = Without Check Valve (only available on 4" model) R = Drain Check Valve and reclaimed water ID	Blue 1.5 to 8.0 Gray low-angle Black short-radius Green high-flow MPR-25-Q, T, H, F MPR-30-Q, T, H, F MPR-35-Q, T, H, F 1.5 to 4.0 = Only nozzles 1.5 to 4.0 can be factory-installed

I-20 (STAINLESS STEEL) – SPECIFICATION BUILDER: ORDER 1 + 2 + 3 + 4

1 Model	2 Standard Features	3 Feature Options	4 Nozzle Options
I-20-04-SS = 4" pop-up I-20-06-SS = 6" pop-up	Adjustable arc, stainless steel riser, check valve, 8 standard nozzles, and 4 low-angle nozzles	(blank) = No option NCV = Without Check Valve (only available on 4" model) R = Drain Check Valve and reclaimed water ID	Blue 1.5 to 8.0 Gray low-angle Black short-radius Green high-flow MPR-25-Q, T, H, F MPR-30-Q, T, H, F MPR-35-Q, T, H, F 1.5 to 4.0 = Only nozzles 1.5 to 4.0 can be factory-installed

Example:

I-20-12-R-4.0 = 12" pop-up, adjustable arc, with reclaimed water ID, and 4.0 nozzle



I-20-00

Overall height: 7¾"
Exposed diameter: 1¾"
Inlet size: ¾"



I-20-04

Overall height: 7½"
Pop-up height: 4"
Exposed diameter: 1¾"
Inlet size: ¾"



I-20-06

Overall height: 9¾"
Pop-up height: 6"
Exposed diameter: 1¾"
Inlet size: ¾"



I-20-12

Overall height: 17"
Pop-up height: 12"
Exposed diameter: 1¾"
Inlet size: ¾"



I-20 Reclaimed

Available as a factory-installed option on all models

PGP® ULTRA & I-20 PRB

Radius: **17' to 46'**
Flow: **0.36 to 9.8 GPM**

The PGP Ultra and I-20 PRB Rotors are built to thrive in applications where high water pressure could otherwise lead to inefficient nozzle operation.

KEY BENEFITS

- Pressure-regulated body (45 PSI) reduces high incoming pressure to increase nozzle efficiency (requires dynamic pressure differential: 15 PSI)
- Patented automatic arc return feature returns the turret back to the original arc pattern if vandalized; adjustable arc from 50° to 360°
- Non-strippable drive mechanism is protected from damage if turned in the opposite direction of travel
- Part- and full-circle in one model for flexibility across landscapes and reduced inventory
- Headed and slotted setscrew allows radius adjustment with a Hunter Wrench or flat-blade screwdriver
- FloStop® Technology stops the flow of water from individual sprinklers, to change the nozzle or perform repairs (I-20 only)
- Flat-top nozzles allow fast, easy insertion
- QuickCheck™ Arc Mechanism for fast arc adjustment
- Available stainless steel riser for extra durability
- Drain Check Valve prevents low-head drainage (up to 10' of elevation)

OPERATING SPECIFICATIONS

- Nozzle choices: 30
- Radius: 17' to 46'
- Flow: 0.36 to 9.8 GPM
- Nozzle discharge pressure: 45 PSI
- Operating pressure range: 60 to 100 PSI
- Precipitation rate: 0.4 in/hr approximately
- Nozzle trajectory: standard = 25°, low-angle = 13°
- Nozzle racks: Blue 1.5 to 8.0, Gray Low-Angle 2.0 to 4.5, Black 0.50 to 3.0, Green 6.0 to 13.0, MPR-25, MPR-30, MPR-35
- Warranty period: 5 years

FACTORY-INSTALLED OPTIONS

- Reclaimed water ID
- Blue 1.5 to 4.0 Nozzles

USER-INSTALLED OPTIONS

- HSJ-0 prefabricated ¾" PVC Swing Joint



PGP-00-PRB

Overall height: 8½"
Exposed diameter: 1¼"
Inlet size: ¾"

PGP-04-PRB

Overall height: 8¾"
Pop-up height: 4"
Exposed diameter: 1¾"
Inlet size: ¾"



I-20-00-PRB

Overall height: 8½"
Exposed diameter: 1¼"
Inlet size: ¾"

I-20-04-PRB

Overall height: 8¾"
Pop-up height: 4"
Exposed diameter: 1¾"
Inlet size: ¾"



I-20-06-PRB

Overall height: 10½"
Pop-up height: 6"
Exposed diameter: 1¾"
Inlet size: ¾"

PGP-ULTRA & I-20 PRB – SPECIFICATION BUILDER: ORDER 1 + 2 + 3 + 4

1 Model	2 Standard Features	3 Feature Options	4 Nozzle Options
PGP-00-PRB = Riser mount PGP-04-PRB = 4" pop-up	Adjustable arc, plastic riser, pressure-regulated body, 8 standard nozzles, and 4 low-angle nozzles	(blank) = No option CV = Drain Check Valve (PGP-04 only) CV-R = Drain Check Valve and reclaimed water ID	Blue 1.5 to 8.0 = Gray low-angle Black short-radius MPR-25, 30, 35 - Q, T, H, F
I-20-00-PRB = Shrub I-20-04-PRB = 4" pop-up I-20-06-PRB = 6" pop-up	Adjustable arc, plastic riser, pressure-regulated body, 8 standard nozzles, and 4 low-angle nozzles	(blank) = No option R = Drain Check Valve and reclaimed water ID	Blue 1.5 to 8.0 = Gray low-angle Black short-radius MPR-25, 30, 35 - Q, T, H, F
I-20-04-SS-PRB = 4" pop-up I-20-06-SS-PRB = 6" pop-up	Adjustable arc, stainless steel riser, pressure-regulated body, 8 standard nozzles, and 4 low-angle nozzles	(blank) = No option R = Drain Check Valve and reclaimed water ID	Blue 1.5 to 8.0 = Gray low-angle Black short-radius MPR-25, 30, 35 - Q, T, H, F

Examples:

- PGP-04-PRB = 4" pop-up, adjustable arc, plastic riser with no factory installed-nozzle
- I-20-04-PRB-3.0-2.5 = 4" pop-up, adjustable arc, plastic riser with 3.0 nozzle
- I-20-06-SS-PRB-R-MPR-25H = 6" pop-up, adjustable arc, stainless steel riser with MPR-25H

PGP ULTRA / I-20 / PRB BLUE STANDARD NOZZLE PERFORMANCE DATA

Nozzle	Pressure PSI	Radius ft.	Flow GPM	Precip in/hr	
				■	▲
1.5 ● Blue	25	29	1.2	0.27	0.32
	35	31	1.4	0.28	0.32
	45	31	1.5	0.30	0.35
	55	32	1.8	0.34	0.39
	65	32	1.9	0.36	0.41
2.0 ● Blue	25	33	1.4	0.25	0.29
	35	33	1.7	0.30	0.35
	45	34	2.0	0.33	0.38
	55	34	2.1	0.35	0.40
	65	32	2.3	0.43	0.50
2.5 ● Blue	25	33	1.7	0.30	0.35
	35	35	2.1	0.33	0.38
	45	35	2.5	0.39	0.45
	55	35	2.6	0.41	0.47
	65	35	2.9	0.46	0.53
3.0 ● Blue	25	35	2.2	0.35	0.40
	35	36	2.7	0.40	0.46
	45	38	3.0	0.40	0.46
	55	39	3.4	0.43	0.50
	65	39	3.7	0.47	0.54
4.0 ● Blue	25	37	3.0	0.42	0.49
	35	39	3.5	0.44	0.51
	45	40	4.0	0.48	0.56
	55	41	4.5	0.52	0.60
	65	41	4.8	0.55	0.63
5.0 ● Blue	25	37	3.7	0.52	0.60
	35	39	4.5	0.57	0.66
	45	42	5.0	0.55	0.63
	55	42	5.7	0.62	0.72
	65	42	6.2	0.68	0.78
6.0 ● Blue	25	38	4.3	0.57	0.66
	35	40	5.6	0.67	0.78
	45	43	6.0	0.62	0.72
	55	44	6.7	0.67	0.77
	65	44	7.3	0.73	0.84
8.0 ● Blue	25	37	6.0	0.84	0.97
	35	41	7.0	0.80	0.93
	45	44	8.0	0.80	0.92
	55	46	9.0	0.82	0.95
	65	46	9.8	0.89	1.03

PGP ULTRA / I-20 / PRB GRAY LOW-ANGLE NOZZLE PERFORMANCE DATA

Nozzle	Pressure PSI	Radius ft.	Flow GPM	Precip in/hr	
				■	▲
2.0 ● LA	30	25	1.6	0.49	0.57
	40	27	1.9	0.50	0.58
	50	28	2.1	0.52	0.60
	Gray	60	30	2.3	0.49
2.5 ● LA	30	27	2.1	0.55	0.64
	40	30	2.5	0.53	0.62
	50	33	2.8	0.49	0.57
	Gray	60	35	3.0	0.47
3.5 ● LA	30	29	2.8	0.64	0.74
	40	32	3.1	0.58	0.67
	50	35	3.5	0.55	0.64
	Gray	60	37	3.8	0.53
4.5 ● LA	30	29	3.4	0.78	0.90
	40	32	3.9	0.73	0.85
	50	35	4.4	0.69	0.80
	Gray	60	37	4.7	0.66

Bold = Recommended pressure

Note:

All precipitation rates calculated for 180° operation.
For the precipitation rate for a 360° sprinkler, divide by 2.

Convenient Nozzle Rack



PGP ULTRA / I-20 / PRB NOZZLES



Blue Standard / Gray Low-Angle (P/N 782900)

Flat-top nozzle for easy insertion coupled with a headed slotted adjustment screw for quick radius adjustment with a Hunter Wrench or a flat-blade screwdriver.



Flat-front nozzle allows easy alignment during installation

I-20-04 Rotor with PRB Body



Pressure Regulation

Continual operating pressure of 45 PSI



PR-075

Overall height: 2¼"
Inlet/outlet size: ¾"
For use under all models ¾" inlet sprinklers, regulates to 45 PSI

PGP ULTRA / I-20 GREEN HIGH-FLOW NOZZLE PERFORMANCE DATA

Nozzle	Pressure PSI	Radius ft.	Flow GPM	Precip in/hr	
				■	▲
10 ● Dk. Green	40	42	8.4	0.92	1.06
	50	43	9.5	0.99	1.14
	60	45	10.5	1.00	1.15
	70	47	11.4	0.99	1.15
13 ● Dk. Green	40	43	10.9	1.13	1.31
	50	44	12.3	1.22	1.41
	60	45	13.6	1.29	1.49
	70	47	14.8	1.29	1.49
6.0 ● LA	30	31	4.2	0.84	0.97
	40	35	5.0	0.79	0.91
	50	37	5.8	0.82	0.94
	60	39	6.3	0.80	0.92
8.0 ● LA	40	37	6.7	0.94	1.09
	50	39	7.7	0.97	1.13
	60	41	8.5	0.97	1.12
	70	41	9.2	1.05	1.22

I-20 Rotor with Blue Standard Nozzle



PGP ULTRA / I-20 / PRB BLACK SHORT-RADIUS NOZZLE PERFORMANCE DATA (18'/25')

Nozzle	Pressure PSI	Radius ft.	Flow GPM	Precip in/hr	
				■	▲
0.50 ● SR	30	17	0.36	0.24	0.28
	40	17	0.43	0.29	0.33
	50	18	0.50	0.30	0.34
	Black 60	19	0.57	0.30	0.35
1.0 ● SR	30	17	0.78	0.52	0.60
	40	17	0.90	0.60	0.69
	50	18	1.00	0.59	0.69
	Black 60	19	1.10	0.59	0.68
2.0 ● SR	30	17	1.40	0.93	1.08
	40	17	1.70	1.13	1.31
	50	18	2.00	1.19	1.37
	Black 60	19	2.20	1.17	1.35
0.75 ● SR	30	23	0.58	0.21	0.24
	40	24	0.68	0.23	0.26
	50	25	0.75	0.23	0.27
	Black 60	26	0.83	0.24	0.27
1.5 ● SR	30	23	1.10	0.40	0.46
	40	24	1.30	0.43	0.50
	50	25	1.50	0.46	0.53
	Black 60	26	1.60	0.46	0.53
3.0 ● SR	30	23	2.50	0.91	1.05
	40	24	2.70	0.90	1.04
	50	25	3.00	0.92	1.07
	Black 60	26	3.10	0.88	1.02

Bold = Recommended pressure

Note:

All precipitation rates calculated for 180° operation. For the precipitation rate for a 360° sprinkler, divide by 2.





PGP ULTRA / I-20 / PRB NOZZLES

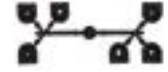





Dk. Green High-Flow (P/N 444800)







Black Short-Radius (P/N 466100)

PGP® ULTRA / I-20 / PRB MPR-25 NOZZLE PERFORMANCE DATA					
Nozzle	Pressure PSI	Radius ft.	Flow GPM	Precip in/hr	
				■	▲
90° 	25	23	0.74	0.54	0.62
	35	24	0.88	0.59	0.68
	45	25	1.00	0.62	0.71
	55	25	1.11	0.68	0.79
	65	25	1.21	0.75	0.86
120° 	25	23	1.00	0.55	0.63
	35	24	1.21	0.61	0.70
	45	25	1.38	0.64	0.74
	55	25	1.53	0.71	0.82
	65	25	1.67	0.77	0.89
180° 	25	23	1.44	0.52	0.61
	35	24	1.73	0.58	0.67
	45	25	1.98	0.61	0.70
	55	25	2.21	0.68	0.79
	65	25	2.41	0.74	0.86
360° 	25	23	2.78	0.51	0.58
	35	24	3.34	0.56	0.64
	45	25	3.82	0.59	0.68
	55	25	4.25	0.65	0.76
	65	25	4.63	0.71	0.82



PGP ULTRA / I-20 / PRB MPR-35 NOZZLE PERFORMANCE DATA					
Nozzle	Pressure PSI	Radius ft.	Flow GPM	Precip in/hr	
				■	▲
90° 	25	32	1.40	0.53	0.61
	35	34	1.67	0.56	0.64
	45	35	1.92	0.60	0.70
	55	35	2.13	0.67	0.77
	65	35	2.31	0.73	0.84
120° 	25	32	1.77	0.50	0.58
	35	34	2.15	0.54	0.62
	45	35	2.46	0.58	0.67
	55	35	2.74	0.65	0.75
	65	35	2.99	0.70	0.81
180° 	25	32	2.75	0.52	0.60
	35	34	3.33	0.55	0.64
	45	35	3.81	0.60	0.69
	55	35	4.23	0.66	0.77
	65	35	4.62	0.73	0.84
360° 	25	32	5.36	0.50	0.58
	35	34	6.62	0.55	0.64
	45	35	7.58	0.60	0.69
	55	35	8.43	0.66	0.76
	65	35	9.18	0.72	0.83



PGP ULTRA / I-20 / PRB MPR-30 NOZZLE PERFORMANCE DATA					
Nozzle	Pressure PSI	Radius ft.	Flow GPM	Precip in/hr	
				■	▲
90° 	25	29	1.03	0.47	0.54
	35	30	1.23	0.53	0.61
	45	30	1.40	0.60	0.69
	55	30	1.56	0.67	0.77
	65	30	1.69	0.72	0.83
120° 	25	29	1.34	0.46	0.53
	35	30	1.62	0.52	0.60
	45	30	1.85	0.59	0.69
	55	30	2.06	0.66	0.76
	65	30	2.24	0.72	0.83
180° 	25	29	2.15	0.49	0.57
	35	30	2.59	0.55	0.64
	45	30	2.96	0.63	0.73
	55	30	3.30	0.71	0.82
	65	30	3.60	0.77	0.89
360° 	25	29	4.24	0.49	0.56
	35	30	5.08	0.54	0.63
	45	30	5.78	0.62	0.71
	55	30	6.39	0.68	0.79
	65	30	6.92	0.74	0.85



PGP-04 Ultra Rotor with MPR-30 Nozzle



I-25

Radius: **37' to 71'**
Flow: **3.8 to 31.5 GPM**

The reliable, durable, and versatile I-25 Rotor offers an expansive nozzle selection that makes it the perfect choice for large turf applications.

KEY BENEFITS

- Patented automatic arc return feature returns the turret back to the original arc pattern if vandalized; adjustable arc from 50° to 360°
- Non-strippable drive mechanism is protected from damage if turned in the opposite direction of travel
- Part- and full-circle in one model for installation flexibility and reduced inventory
- Color-coded nozzles make identification easy
- QuickCheck™ Arc Mechanism for fast arc adjustment
- Available stainless steel riser for extra durability
- Drain Check Valve prevents low-head drainage (up to 10' of elevation)

OPERATING SPECIFICATIONS

- Nozzle choices: 11
- Radius: 37' to 71'
- Flow: 3.8 to 31.5 GPM
- Recommended pressure range: 40 to 100 PSI
- Operating pressure range: 40 to 100 PSI
- Precipitation rates: 0.4 in/hr approximately
- Nozzle trajectory: standard = 25°
- Warranty period: 5 years

FACTORY-INSTALLED OPTIONS

- Reclaimed water ID
- High-speed rotations

USER-INSTALLED OPTIONS

- HSJ-1 prefabricated 1" PVC Swing Joint



I-25-04

Overall height: 7 7/8"
Pop-up height: 4"
Exposed diameter: 1 3/4"
Inlet size: 1"



I-25-06

Overall height: 10 1/4"
Pop-up height: 6"
Exposed diameter: 1 3/4"
Inlet size: 1"



I-25 Reclaimed

Available as a factory-installed option on all models



I-25 High-Speed

Available as a factory-installed option on stainless steel models

I-25 (PLASTIC) - SPECIFICATION BUILDER: ORDER 1 + 2 + 3 + 4

1 Model	2 Standard Features	3 Feature Options	4 Nozzle Options
I-25-04 = 4" pop-up I-25-06 = 6" pop-up	Adjustable arc, plastic riser, check valve, and 5 nozzles	(blank) = No option R = Reclaimed water ID	4 to 28 = Factory-installed nozzle number

I-25 (STAINLESS STEEL) - SPECIFICATION BUILDER: ORDER 1 + 2 + 3 + 4

1 Model	2 Standard Features	3 Feature Options	4 Nozzle Options
I-25-04-SS = 4" pop-up I-25-06-SS = 6" pop-up	Adjustable arc, stainless steel riser, check valve, and 5 nozzles	(blank) = No option R = Reclaimed water ID HS = High-speed HS-R = High-speed and reclaimed water ID	4 to 28 = Factory-installed nozzle number

Examples:

- I-25-04 = 4" pop-up, adjustable arc
- I-25-04-SS-R-18 = 4" pop-up, adjustable arc, stainless steel riser, reclaimed water ID, and 18 nozzle
- I-25-06-SS = 6" pop-up, adjustable arc, stainless steel riser

I-25 STANDARD NOZZLE PERFORMANCE DATA

Nozzle	Pressure PSI	Radius ft.	Flow GPM	Precip in/hr	
				■	▲
04 ● Yellow	40	40	3.8	0.46	0.53
	50	41	4.3	0.49	0.57
	60	42	4.7	0.51	0.59
	70	43	5.1	0.53	0.61
07 ● Orange*	40	45	6.6	0.63	0.72
	50	47	7.0	0.61	0.70
	60	48	7.5	0.63	0.72
	70	49	7.9	0.63	0.73
08 ● Lt. Brown	40	47	7.7	0.67	0.77
	50	49	8.3	0.67	0.77
	60	50	9.2	0.71	0.82
	70	51	9.9	0.73	0.85
10 ● Lt. Green*	50	51	10.1	0.75	0.86
	60	52	11.1	0.79	0.91
	70	53	12.1	0.83	0.96
	80	54	12.9	0.85	0.98
13 ● Lt. Blue	50	53	11.2	0.77	0.89
	60	54	12.3	0.81	0.94
	70	55	13.3	0.85	0.98
	80	55	14.3	0.91	1.05
15 ● Gray*	50	56	13.4	0.82	0.95
	60	57	14.3	0.85	0.98
	70	57	15.2	0.90	1.04
	80	58	16.4	0.94	1.08
18 ● Red	50	58	14.5	0.83	0.96
	60	59	15.7	0.87	1.00
	70	62	16.9	0.85	0.98
	80	63	18.2	0.88	1.02
20 ● Dk. Brown*	60	62	17.8	0.89	1.03
	70	63	19.2	0.93	1.08
	80	64	20.5	0.96	1.11
	90	65	21.8	0.99	1.15
23 ● Dk. Green	60	64	21.9	1.03	1.19
	70	65	23.6	1.08	1.24
	80	66	25.6	1.13	1.31
	90	67	27.0	1.16	1.34
25 ● Dk. Blue*	60	66	23.5	1.04	1.20
	70	68	25.5	1.06	1.23
	80	69	28.0	1.13	1.31
	90	70	29.5	1.16	1.34
28 ● Black	70	68	26.9	1.12	1.29
	80	70	28.7	1.13	1.30
	90	71	30.6	1.17	1.35
	100	71	31.5	1.20	1.39

I-25 HIGH-SPEED NOZZLE PERFORMANCE DATA

Nozzle	Pressure PSI	Radius ft.	Flow GPM	Precip in/hr	
				■	▲
04 ● Yellow	40	37	3.8	0.53	0.62
	50	38	4.3	0.57	0.66
	60	38	4.7	0.63	0.72
	70	39	5.1	0.65	0.75
07 ● Orange*	40	40	6.6	0.79	0.92
	50	41	7.0	0.80	0.93
	60	42	7.5	0.82	0.95
	70	44	7.9	0.79	0.91
08 ● Lt. Brown	40	42	7.7	0.84	0.97
	50	43	8.3	0.86	1.00
	60	44	9.2	0.91	1.06
	70	45	9.9	0.94	1.09
10 ● Lt. Green*	50	46	10.1	0.92	1.06
	60	48	11.1	0.93	1.07
	70	49	12.1	0.97	1.12
	80	50	12.9	0.99	1.15
13 ● Lt. Blue	50	48	11.2	0.94	1.08
	60	49	12.3	0.99	1.14
	70	51	13.3	0.98	1.14
	80	51	14.3	1.06	1.22
15 ● Gray*	50	49	13.4	1.07	1.24
	60	51	14.3	1.06	1.22
	70	53	15.2	1.04	1.20
	80	54	16.4	1.08	1.25
18 ● Red	50	50	14.5	1.12	1.29
	60	53	15.7	1.08	1.24
	70	55	16.9	1.08	1.24
	80	57	18.2	1.08	1.25
20 ● Dk. Brown*	60	53	17.8	1.22	1.41
	70	56	19.2	1.18	1.36
	80	58	20.5	1.17	1.35
	90	59	21.8	1.21	1.39
23 ● Dk. Green	60	56	21.9	1.34	1.55
	70	58	23.6	1.35	1.56
	80	60	25.6	1.37	1.58
	90	61	27.0	1.40	1.61
25 ● Dk. Blue*	60	58	23.5	1.34	1.55
	70	62	25.5	1.28	1.47
	80	64	28.0	1.32	1.52
	90	66	29.5	1.30	1.51
28 ● Black	70	60	26.9	1.44	1.66
	80	62	28.7	1.44	1.66
	90	65	30.6	1.39	1.61
	100	67	31.5	1.35	1.56

I-25 NOZZLE

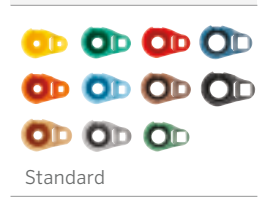

* Five standard nozzles included with each sprinkler.

Note:

All precipitation rates calculated for 180° operation. For the precipitation rate for a 360° sprinkler, divide by 2.

I-40

Radius: **44' to 76'**
Flow: **7.6 to 33.7 GPM**

The I-40 Rotor has a comprehensive list of upgraded features that make it the top choice for demanding, large turf projects.

KEY BENEFITS

- Patented automatic arc return feature returns the turret back to the original arc pattern if vandalized; adjustable arc from 50° to 360°
- Non-strippable drive mechanism is protected from damage if turned in the opposite direction of travel
- Part- and full-circle in one model for flexibility across landscapes and reduced inventory
- Color-coded nozzles make identification easy
- Available opposing nozzle model for even watering in full-circle applications (I-40-ON model)
- Drain Check Valve prevents low-head drainage (up to 15' of elevation)

OPERATING SPECIFICATIONS

- Nozzle choices: 12
- Radius I-40: 44' to 69'
- Radius I-40-ON: 52' to 76'
- Flow I-40: 7.6 to 29.5 GPM
- Flow I-40-ON: 13.0 to 33.7 GPM
- Recommended pressure range: 40 to 100 PSI
- Operating pressure range: 40 to 100 PSI
- Precipitation rate: 0.4 in/hr approximately
- Nozzle trajectory: standard = 25°
- Warranty period: 5 years

FACTORY-INSTALLED OPTIONS

- Reclaimed water ID
- High-speed rotations

USER-INSTALLED OPTIONS

- HSJ-1 prefabricated 1" PVC Swing Joint



I-40-04

Overall height: 7⁷/₈"
Pop-up height: 4"
Exposed diameter: 2"
Inlet size: 1"



I-40-06

Overall height: 10¹/₄"
Pop-up height: 6"
Exposed diameter: 2"
Inlet size: 1"



I-40 Reclaimed

Available as a factory-installed option on all models



I-40 High-Speed

Available as a factory-installed option on all models

I-40 - SPECIFICATION BUILDER: ORDER 1 + 2 + 3 + 4

1 Model	2 Standard Features	3 Feature Options	4 Nozzle Options
I-40-04-SS = 4" pop-up I-40-06-SS = 6" pop-up	Adjustable arc, stainless steel riser, check valve, and 6 nozzles	(blank) = No option HS = High-speed HS-R = High-speed and reclaimed water ID R = Reclaimed water ID	8 to 25 = Factory-installed nozzle number

I-40-ON - SPECIFICATION BUILDER: ORDER 1 + 2 + 3 + 4

1 Opposing Nozzle Model	2 Standard Features	3 Feature Options	4 Nozzle Options
I-40-04-SS-ON = 4" pop-up I-40-06-SS-ON = 6" pop-up	Full-circle, opposing nozzle, stainless steel riser, check valve, and 6 nozzles	(blank) = No option HS = High-speed HS-R = High-speed and reclaimed water ID R = Reclaimed water ID	15 to 28 = Factory-installed nozzle number

Examples:

I-40-04-SS = 4" pop-up, adjustable arc, stainless steel riser, with check valve

I-40-04-SS-ON-R-23 = 4" pop-up, adjustable arc, stainless steel riser, with check valve, and reclaimed water ID and 23 nozzle

I-40-06-SS-15 = 6" pop-up, adjustable arc, stainless steel riser, with check valve and 15 nozzle

I-40 NOZZLE PERFORMANCE DATA					
Nozzle	Pressure PSI	Radius ft	Flow GPM	Precip in/hr	
				■	▲
08 ● Lt. Brown	40	44	7.6	0.76	0.87
	50	45	8.4	0.80	0.92
	60	46	9.2	0.84	0.97
10 ● Lt. Green	50	49	10.3	0.83	0.95
	60	50	11.3	0.87	1.00
	70	51	12.2	0.90	1.04
13 ● Lt. Blue	80	51	13.0	0.96	1.11
	50	50	11.1	0.85	0.99
	60	51	12.3	0.91	1.05
15 ● Gray	70	52	13.3	0.95	1.08
	80	53	14.2	0.97	1.12
	50	54	13.8	0.91	1.05
23 ● Dk. Green	60	55	15.7	1.00	1.15
	70	57	16.6	0.98	1.14
	80	59	18.3	1.01	1.17
25 ● Dk. Blue	60	62	21.3	1.07	1.23
	70	64	23.0	1.08	1.25
	80	65	24.5	1.12	1.29
25 ● Dk. Blue	90	66	25.9	1.14	1.32
	60	66	23.9	1.06	1.22
	70	67	25.8	1.11	1.28
25 ● Dk. Blue	80	68	27.7	1.15	1.33
	90	69	29.5	1.19	1.38

I-40 HIGH-SPEED NOZZLE PERFORMANCE DATA					
Nozzle	Pressure PSI	Radius ft	Flow GPM	Precip in/hr	
				■	▲
08 ● Lt. Brown	40	41	7.6	0.87	1.00
	50	41	8.4	0.96	1.11
	60	42	9.2	1.00	1.16
10 ● Lt. Green	50	45	10.3	0.98	1.13
	60	46	11.3	1.03	1.19
	70	47	12.2	1.06	1.23
13 ● Lt. Blue	80	47	13.0	1.13	1.31
	50	46	11.1	1.01	1.17
	60	47	12.3	1.07	1.24
15 ● Gray	70	48	13.3	1.11	1.28
	80	49	14.2	1.14	1.31
	50	51	13.8	1.02	1.18
23 ● Dk. Green	60	52	15.7	1.12	1.29
	70	53	16.6	1.14	1.31
	80	54	18.3	1.21	1.40
23 ● Dk. Green	60	58	21.3	1.22	1.41
	70	59	23.0	1.27	1.47
	80	60	24.5	1.31	1.51
25 ● Dk. Blue	90	61	25.9	1.34	1.55
	60	59	23.9	1.32	1.53
	70	61	25.8	1.33	1.54
25 ● Dk. Blue	80	62	27.7	1.39	1.60
	90	63	29.5	1.43	1.65



I-40 Turf Cup Kit Option
Available as a field-installed option on all models
P/N TURFCUPKIT140

I-40 DUAL OPPOSING NOZZLE PERFORMANCE DATA					
Nozzle	Pressure PSI	Radius ft	Flow GPM	Precip in/hr	
				■	▲
15 ● Gray	50	52	13.0	0.46	0.53
	60	54	13.2	0.44	0.50
	70	56	14.4	0.44	0.51
	80	57	15.5	0.46	0.53
18 ● Red	50	58	13.7	0.39	0.45
	60	59	15.2	0.42	0.49
	70	60	16.6	0.44	0.51
20 ● Dk. Brown	80	62	17.8	0.45	0.51
	60	63	19.1	0.46	0.53
	70	64	20.9	0.49	0.57
23 ● Dk. Green	80	66	22.3	0.49	0.57
	90	66	23.9	0.53	0.61
	60	65	20.4	0.46	0.54
25 ● Dk. Blue	70	66	22.3	0.49	0.57
	80	67	24.0	0.51	0.59
	90	68	25.6	0.53	0.62
25 ● Dk. Blue	60	66	22.0	0.49	0.56
	70	68	24.0	0.50	0.58
	80	69	25.9	0.52	0.60
28 ● Black	90	70	27.2	0.53	0.62
	70	70	28.9	0.57	0.66
	80	72	30.9	0.57	0.66
28 ● Black	90	74	32.9	0.58	0.67
	100	76	33.7	0.56	0.65

Notes:
All precipitation rates calculated for 180° operation.
For the precipitation rate for a 360° sprinkler, divide by 2.
Precipitation rates for the ON Opposing Nozzle model are calculated at 360°.



I-80

Radius: **63' to 97'**
Flow: **20.2 to 59.6 GPM**

The highly versatile and efficient I-80 Rotor is the first commercial sports turf rotor with no-dig Total-Top-Serviceability.

KEY BENEFITS

- Exclusive Total-Top-Service (TTS) design provides convenient no-dig servicing
- Exclusive PressurePort™ Technology creates exceptional nozzle uniformity
- Forward-facing triple nozzles (I-80) or opposing triple nozzles (I-80-ON) create uniform nozzle profiles in part and full-circle applications
- QuickCheck™ Arc Mechanism (I-80) for fast arc adjustment and review of the arc setting
- QuickSet-360 Arc Mechanism (I-80) converts adjustable arc rotor to full-circle in an instant
- Part- and full-circle in one model provides flexible installation options and reduces inventory (I-80)
- Ratcheting stainless steel riser allows setting of right-side fixed arc alignment to the landscape without rotor disassembly
- Drain Check Valve prevents low-head drainage (up to 5' of elevation)

OPERATING SPECIFICATIONS

- I-80
 - Standard 22.5° nozzle choices: 7
 - Radius: 65' to 94'
 - Flow: 20.2 to 59.6 GPM
 - Pressure range: 50 to 100 PSI
- Precipitation rates: 0.45 in/hr approximately
- Warranty period: 5 years
- I-80-ON
 - Standard 22.5° nozzle choices: 7
 - Radius: 63' to 97'
 - Flow: 21.6 to 58.5 GPM
 - Pressure range: 65 to 100 PSI
- All I-80 Rotors are pressure-rated at 150 PSI

FACTORY-INSTALLED OPTIONS

- Exclusive Turf Cup option for an aesthetically clean and safe installation:
 - No-dig servicing of riser assembly
 - No-dig arc adjustments
 - Quick-release turf cup assembly
 - Threads in cup lock/retain the turf

USER-INSTALLED OPTIONS

- Rubber Cover Kit: P/N 959300SP
- Turf Cup Kit: P/N 959400SP
- HSJ prefabricated PVC Swing Joints
- Reclaimed water ID: P/N 450105



I-80-04-SS Pop-Up
I-80-04-SS-ON Pop-Up
Overall height: 9¾"
Pop-up height: 3¾"
Exposed diameter: 4¾"
Inlet size: 1½"



I-80-04-SS-TC Turf Cup
I-80-04-SS-ON-TC Turf Cup
Overall height: 11½"
Pop-up height: 3¾"
Exposed diameter: 3½"
Inlet size: 1½"



I-80 Turf Cup Kit
P/N 959400SP



I-80 Rubber Cover Kit
P/N 959300SP









I-80 - SPECIFICATION BUILDER: ORDER 1 + 2 + 3 + 4

1 Model	2 Standard Features	3 Nozzle Options
I-80-04-SS = 4" pop-up	Adjustable arc, stainless steel riser, check valve, and 15 nozzle options	23 to 53 = Factory-installed nozzle number, no nozzle pack
I-80-04-SS-TC = 4" pop-up with turf cup	Adjustable arc, stainless steel riser, check valve, factory-installed turf cup, and 15 nozzle options	
I-80-04-SS-ON = 4" pop-up	Full-circle, opposing nozzle, stainless steel riser, check valve, and 15 nozzle options	23 to 53 = Factory-installed nozzle number, no nozzle pack
I-80-04-SS-ON-TC = 4" pop-up with turf cup	Full-circle, opposing nozzle, stainless steel riser, check valve, factory-installed turf cup, and 15 nozzle options	

Examples:









- I-80-04-SS-25 = 4" pop-up, adjustable arc, stainless steel riser, check valve, and factory-installed 25 nozzle
- I-80-04-SS-ON-38 = 4" pop-up, stainless steel riser, check valve, opposing nozzle full-circle, and factory-installed 38 nozzle
- I-80-04-SS-ON-TC-48 = 4" pop-up, stainless steel riser, check valve, opposing nozzle full-circle, factory-installed turf cup, and factory-installed 48 nozzle

I-80 NOZZLE PERFORMANCE DATA*

Nozzle Set			Pressure	Radius	Flow	Precip in/hr	
			PSI	ft.	GPM	■	▲
Orange 803603 ●	 23 Green	Lt. Green 315313 ●	50	65	20.2	0.46	0.53
			60	66	22.1	0.49	0.56
			65	67	23.9	0.51	0.59
			70	67	24.2	0.52	0.60
Orange 803603 ●	 25 Blue	Lt. Green 315313 ●	65	71	28.3	0.54	0.62
			70	72	29.3	0.54	0.63
			80	73	31.5	0.57	0.66
			90	74	33.4	0.59	0.68
Orange 803603 ●	 33 Gray	Lt. Green 315313 ●	65	72	30.6	0.57	0.66
			70	73	31.6	0.57	0.66
			80	75	33.9	0.58	0.67
			90	77	35.8	0.58	0.67
Orange 803603 ●	 38 Red	Lt. Green 315313 ●	65	76	34.9	0.58	0.67
			70	78	36.2	0.57	0.66
			80	80	39.1	0.59	0.68
			90	82	41.2	0.59	0.68
Orange 803603 ●	 43 Dk. Brown	Lt. Green 315313 ●	-	-	-	-	-
			70	81	41.2	0.60	0.70
			80	83	43.5	0.61	0.70
			90	86	46.2	0.60	0.69
Orange 803603 ●	 48 Dk. Green	Lt. Green 315313 ●	-	-	-	-	-
			70	83	46.3	0.65	0.75
			80	85	48.4	0.64	0.74
			90	89	51.7	0.63	0.73
Orange 803603 ●	 53 Dk. Blue	Lt. Green 315313 ●	-	-	-	-	-
			70	87	50.7	0.64	0.74
			80	89	53.1	0.65	0.75
			90	92	56.4	0.64	0.74
Orange 803603 ●	 53 Dk. Blue	Lt. Green 315313 ●	100	94	59.6	0.65	0.75

● = Nozzle plug P/N 315300 installed in the back side of the nozzle housing.
 * Complies to ASAE standard. All precipitation rates calculated for 360° operation. All triangular rates are equilateral.

I-80-ON NOZZLE PERFORMANCE DATA*

Nozzle Set			Pressure	Radius	Flow	Precip in/hr	
			PSI	ft.	GPM	■	▲
● Tan 803611 ●	 23 Green	● Lt. Blue 315311 ●	50	63	21.6	0.52	0.60
			60	65	23.0	0.52	0.61
			65	66	24.0	0.53	0.61
			70	67	24.9	0.53	0.62
● Tan 803611 ●	 25 Blue	● Lt. Blue 315311 ●	65	71	28.6	0.55	0.63
			70	73	29.7	0.54	0.62
			80	74	31.7	0.56	0.64
			90	75	33.7	0.58	0.67
● Tan 803611 ●	 33 Gray	● Lt. Blue 315311 ●	65	74	30.9	0.54	0.63
			70	75	32.0	0.55	0.63
			80	77	34.2	0.56	0.64
			90	79	36.2	0.56	0.64
● Tan 803611 ●	 38 Red	● Lt. Blue 315311 ●	65	77	35.1	0.57	0.66
			70	79	36.6	0.56	0.65
			80	82	38.9	0.56	0.64
			90	84	41.3	0.56	0.65
● Tan 803611 ●	 43 Dk. Brown	● Lt. Blue 315311 ●	-	-	-	-	-
			70	83	41.3	0.58	0.67
			80	85	43.6	0.58	0.67
			90	87	46.3	0.59	0.68
● Tan 803611 ●	 48 Dk. Green	● Lt. Blue 315311 ●	-	-	-	-	-
			70	90	46.9	0.56	0.64
			80	92	48.9	0.56	0.64
			90	94	50.5	0.55	0.63
● Tan 803611 ●	 53 Dk. Blue	● Lt. Blue 315311 ●	-	-	-	-	-
			70	91	49.8	0.58	0.67
			80	93	52.2	0.58	0.67
			90	95	55.5	0.59	0.68
● Tan 803611 ●	 53 Dk. Blue	● Lt. Blue 315311 ●	100	97	58.5	0.60	0.69

● = Nozzle plug P/N 315300 installed in the front side of the nozzle housing.

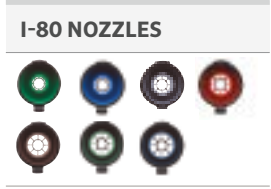

I-90

Radius: **66' to 103'**
Flow: **29.5 to 83.8 GPM**

The robust I-90 Rotor is built for long-distance natural turf applications in large parks, open spaces, and sports fields.

KEY BENEFITS

- Exclusive PressurePort™ Technology creates exceptional nozzle uniformity
- Forward-facing triple nozzles (I-90), opposing triple nozzles (I-90-ON) create uniform nozzle profiles in part- and full-circle applications
- QuickCheck™ Arc Mechanism for fast arc adjustment and review of the arc setting
- Part- and full-circle in one model provides flexible installation options and decreases inventory (I-90)
- Drain Check Valve prevents low-head drainage (up to 9' of elevation)

OPERATING SPECIFICATIONS

- I-90 nozzle choices: 8
- Radius I-90 ADV: 66' to 97'
- Radius I-90 36V: 73' to 103'
- Flow I-90 ADV: 30.5 to 83.3 GPM
- Flow I-90 36V: 14.2 to 58.5 GPM
- Recommended pressure range: 80 to 120 PSI
- Operating pressure range: 80 to 120 PSI
- Precipitation rate: 0.75 in/hr approximately
- Warranty period: 5 years

FACTORY-INSTALLED OPTIONS

- Reclaimed water ID

USER-INSTALLED OPTIONS

- Rubber Cover Kit: P/N 234200
- Turf Cup Kit: P/N 467955
- HSJ prefabricated PVC 1½" Swing Joints



I-90

Overall height: ADV/36V: 11"
Pop-up height: 3"
Exposed diameter: 3½"
Inlet size: 1½"



Turf Cup Kit
P/N 467955



Rubber Cover Kit
P/N 234200



I-90 Reclaimed

Available as a factory-installed option on all models

I-90 - SPECIFICATION BUILDER: ORDER 1 + 2 + 3 + 4

1 Model	2 Standard Features	3 Feature Options	4 Nozzle Options
I-90 = 3" pop-up	Plastic riser, check valve, and 8 nozzles	ADV = Adjustable arc ARV = Adjustable arc and reclaimed water ID 36V = Full-circle, opposing nozzles 3RV = Full-circle, opposing nozzles, and reclaimed water ID	25 to 73 = Factory-installed nozzle number

Examples:

I-90-ADV = 3" pop-up, adjustable arc

I-90-36V-43 = 3" pop-up, full-circle, opposing nozzles, and 43 nozzle

I-90-3RV-63 = 3" pop-up, full-circle, opposing nozzles, reclaimed water ID, and 63 nozzle

I-90-ADV NOZZLE PERFORMANCE DATA					
Nozzle	Pressure PSI	Radius ft.	Flow GPM	Precip in/hr	
				■	▲
25 ● Lt. Blue	80	66	29.5	1.30	1.51
	90	67	31.5	1.35	1.56
	100	68	33.2	1.38	1.60
	110	69	35.6	1.44	1.66
33 ● Gray	80	68	36.2	1.51	1.74
	90	69	38.2	1.54	1.78
	100	70	40.4	1.59	1.83
	110	71	42.6	1.63	1.88
38 ● Red	80	72	40.6	1.51	1.74
	90	73	43.0	1.55	1.79
	100	75	45.4	1.55	1.79
	110	76	47.6	1.59	1.83
43 ● Dk. Brown	80	74	46.1	1.62	1.87
	90	74	48.5	1.70	1.97
	100	75	50.7	1.74	2.00
	110	77	53.4	1.73	2.00
48 ● Dk. Green	80	77	50.2	1.63	1.88
	90	79	52.6	1.62	1.87
	100	81	55.1	1.62	1.87
	110	82	57.5	1.65	1.90
53 ● Dk. Blue*	80	81	54.9	1.61	1.86
	90	84	57.2	1.56	1.80
	100	86	59.5	1.55	1.79
	110	87	62.1	1.58	1.82
	120	88	64.4	1.60	1.85
63 ● Black	80	86	62.3	1.62	1.87
	90	88	65.5	1.63	1.88
	100	90	69.0	1.64	1.89
	110	91	71.9	1.67	1.93
	120	92	74.7	1.70	1.96
73 ● Orange	80	89	72.7	1.77	2.04
	90	91	75.4	1.75	2.02
	100	93	78.1	1.74	2.01
	110	95	80.9	1.73	1.99
	120	97	83.8	1.71	1.98

I-90-36V NOZZLE PERFORMANCE DATA					
Nozzle	Pressure PSI	Radius ft.	Flow GPM	Precip in/hr	
				■	▲
25 ● Lt. Blue	80	73	30.5	0.55	0.64
	90	75	32.4	0.55	0.64
	100	76	34.3	0.57	0.66
	110	78	36.5	0.58	0.67
33 ● Gray	80	77	36.3	0.59	0.68
	90	78	38.4	0.61	0.70
	100	80	40.6	0.61	0.71
	110	81	42.7	0.63	0.72
38 ● Red	80	80	40.6	0.61	0.71
	90	82	42.9	0.61	0.71
	100	83	45.3	0.63	0.73
	110	85	47.7	0.64	0.73
43 ● Dk. Brown	80	83	46.2	0.65	0.75
	90	84	48.6	0.66	0.77
	100	85	50.9	0.68	0.78
	110	86	53.4	0.69	0.80
48 ● Dk. Green	80	86	49.6	0.65	0.75
	90	89	52.5	0.64	0.74
	100	90	54.8	0.65	0.75
	110	91	57.3	0.67	0.77
53 ● Dk. Blue*	80	89	54.2	0.66	0.76
	90	90	56.7	0.67	0.78
	100	92	59.2	0.67	0.78
	110	93	61.7	0.69	0.79
	120	94	64.2	0.70	0.81
63 ● Black	80	92	63.2	0.72	0.83
	90	94	65.9	0.72	0.83
	100	96	69.4	0.72	0.84
	110	97	72.0	0.74	0.85
	120	98	74.9	0.75	0.87
73 ● Orange	80	96	72.1	0.75	0.87
	90	98	75.0	0.75	0.87
	100	99	77.8	0.76	0.88
	110	102	80.5	0.74	0.86
	120	103	83.3	0.76	0.87



* Factory-installed nozzle

Notes:

Precipitation rates for ADV models are calculated for 180° operation. Precipitation rates for 36V models are calculated for 360° operation. All triangular rates are equilateral. Complies to ASAE standard.

I-90



HSJ SWING JOINTS

With swivel ells on both ends, HSJ Swing Joints easily adjust sprinklers to proper height and position in any configuration.

ROTORS

KEY BENEFITS









- Strength, longevity, and contamination resistance
 - Prefabricated PVC design with O-ring seals
- Configurations to meet every installation requirement
 - Available in all popular inlet and outlet configurations
 - Choose from 8", 12", or 18" lay arm lengths
 - Single top-out or triple top-out designs

Swing Joints

- HSJ-0 = Model 3/4"
- HSJ-1 = Model 1"
- HSJ-2 = Model 1 1/4"
- HSJ-3 = Model 1 1/2"



HSJ SWING JOINT - SPECIFICATION BUILDER: ORDER 1 + 2 + 3 + 4

1 Model	2 Inlet Type (from pipe fitting)	3 Outlet Type (to sprinkler inlet)	4 Outlet Style	5 Lay Length
HSJ-0 = 3/4" commercial Swing Joint HSJ-1 = 1" heavy-duty Swing Joint HSJ-2 = 1 1/4" heavy-duty Swing Joint HSJ-3 = 1 1/2" heavy-duty Swing Joint	2 = Spigot, short  3 = Male NPT  7 = Spigot, 4" long*  * Not available HSJ-0	2 = Male NPT 	2 = Single top-out  4 = Triple top-out 	08 = 8" lay arm*  12 = 12" lay arm  18 = 18" lay arm  * HSJ-0 only

Example:

HSJ-1-3-2-2-12 = HSJ 1" heavy-duty Swing Joint, 1" NPT inlet, 1" male NPT single top-out outlet, 12" lay arm length

HCV CHECK VALVES

Eliminate low-head drainage for both rotor and spray shrub systems with the adjustable HCV Check Valves.

KEY BENEFITS

- Adjustment access through top of valve
- Adjusts to compensate for elevational changes up to 32'
- Variety of inlet and outlet options reduces need for additional fittings
- Meets schedule 80 specifications for durability under high pressure
- Pressure loss charts for HCV products on [page 205](#)

HCV CHECK VALVES

Model	Description
HC-50F-50F	1/2" female inlet x 1/2" female outlet
HC-50F-50M	1/2" female inlet x 1/2" male outlet
HC-75F-75M	3/4" female inlet x 3/4" male outlet



HCV Check Valves
Overall height: 3"

SNAPLOK™ COMBO KITS







These kits are designed for applications that demand sturdy installation due to frequent quick coupler use.

KEY BENEFITS

- Highly effective solution for quick-coupler stabilization
- SnapLok design includes:
 - Heavy-duty PVC and brass outlet construction
 - Anti-rotation coupler locking feature
 - Accommodates both rebar and pipe stabilization
- Solves common quick-coupler stabilization and unthreading concerns
 - Unique SnapLok outlet with integrated brass thread outlet
- See the HSJ Swing Joints on [page 33](#)



SNAPLOK COMBO KITS - SPECIFICATION BUILDER: ORDER 1 + 2 + 3 + 4

1 Model	2 Inlet Type (from pipe fitting)	3 Outlet Type (to sprinkler inlet)	4 Outlet Style	5 Lay Length
HSJ-1 = 1" heavy-duty Swing Joint	3 = Male NPT 	S = Male 1" brass NPT SnapLok  T = Male 3/4" brass NPT/BSP SnapLok 	2 = Single top-out 	12 = 12" lay arm  18 = 18" lay arm 

SnapLok is a trademark of LASCO Fittings Inc.

ST SYSTEMS

ST SYSTEMS



ST-90

The ST-90 Synthetic Turf Rotor is designed for installation in natural turf adjacent to the playing surface — the perfect solution for small and midsize fields.

KEY BENEFITS

- Arc setting: 40° to 360°
- QuickCheck™ Arc Mechanism
- Through-the-top arc adjustment
- Water-lubricated gear drive
- Factory-installed rubber logo cap
- Nozzle trajectory: 22.5°

OPERATING SPECIFICATIONS

- Radius: 103' to 120'
- Flow: 74.5 to 92.0 GPM
- Operating pressure range: 100 to 120 PSI
- Precipitation rate: 1.25 in/hr approximately
- Warranty period: 5 years for component parts

USER-INSTALLED OPTIONS

- Rubber Cover Kit ST-90: P/N 234200SP

ST ROTOR	
Model	Description
ST-90-XX	3" pop-up, jar-top cap, adjustable arc, plastic riser, and NPT inlet threads, 73 or 83 preinstalled nozzle



ST-90*
 Overall height: 11½"
 Pop-up height: 3"
 Diameter: 5½"
 Inlet size: 1½" NPT

*Not for use with the ST Vault

ST-90 NOZZLE PERFORMANCE DATA

Nozzle	Pressure PSI	Radius ft.	Flow GPM	Precip in/hr	
				■	▲
73 ●	100	103	74.5	1.35	1.56
	110	109	77.0	1.25	1.44
	120	115	79.6	1.16	1.34
83 ●	100	112	84.2	1.29	1.49
	110	116	88.1	1.26	1.46
	120	120	92.0	1.23	1.42

Notes:

All precipitation rates are calculated for 180° operation. For the precipitation rate of a 360° sprinkler, divide by 2.

HIGH-FLOW SWING JOINTS

These durable Swing Joints are easy to position and ensure correct rotor installation height.

KEY BENEFITS

- Heavy-duty, high-flow Swing Joints with O-ring seals
- HSJ-4 for high-flow I-90 and ST-90 Rotors with 1½" inlets

High-Flow Swing Joints
 HSJ-4 = 2" model



HSJ HIGH-FLOW SWING JOINT – SPECIFICATION BUILDER: ORDER 1 + 2 + 3 + 4

1 Model	2 Inlet Type (from pipe fitting)	3 Outlet Type (to sprinkler inlet)	4 Outlet Style	5 Lay Length
HSJ-4 = 2" heavy-duty Swing Joint	3 = 2" male NPT, horizontal side connection	7 = 1½" male NPT	2 = Single top-out	12 = 12" lay arm

Example:

HSJ-4-37-212 = HSJ 2" heavy-duty Swing Joint, 2" male NPT horizontal side connection to piping, 1½" male NPT outlet to sprinkler, single top-out, and 12" lay arm

ST-1200-BR

The cost-effective ST-1200-BR Rotor is the ideal riser-mounted solution for pastures, corrals, arenas, dust control, and wash-down watering.

KEY BENEFITS

- Nozzle choices: 5 (included)
- Standard nozzle: 12
- Nozzle range: 10 to 18
- Nozzle trajectory: 22.5°
- Isolated, grease-lubricated gear drive
- Nozzle barrels: short and long (included)
- Movable stops (left and right) arc adjustment
- Arc setting: 40° to non-reversing 360°
- Ratcheting nozzle turret

OPERATING SPECIFICATIONS

- Radius: 67' to 115'
- Flow: 27.0 to 131.0 GPM
- Pressure range: 30 to 85 PSI



ST-1200-BR

Overall height: 12"
Overall length: 12" (Long Barrel)
Overall width: 3¾"
Inlet size: 1½" BSP*

*Use P/N 241401SP 1½" male spigot x 1½" BSP adapter if needed

Included

Short and long barrels



ST-1200-BR NOZZLE PERFORMANCE DATA

Nozzle	Pressure PSI	Radius ft.	Flow GPM	Precip in/hr	
				■	▲
10 ● Black	30	67	27.0	1.16	1.34
	45	75	32.8	1.12	1.30
	60	85	38.1	1.02	1.17
	75	90	43.5	1.03	1.19
12 ● Black	30	68	33.6	1.40	1.62
	45	78	41.2	1.30	1.51
	60	88	47.6	1.18	1.37
	75	98	53.1	1.06	1.23
14 ● Black	30	70	45.7	1.80	2.07
	45	86	56.0	1.46	1.68
	60	100	64.7	1.25	1.44
	75	110	72.5	1.15	1.33
16 ● Black	30	72	59.5	2.21	2.55
	45	93	73.0	1.62	1.88
	60	103	84.3	1.53	1.77
	75	116	80.9	1.16	1.34
18 ● Black	30	95	92.5	1.97	2.28
	45	104	107.0	1.90	2.20
	60	111	119.5	1.87	2.16
	75	115	131.0	1.91	2.20

ST-1200-BR Rotor Installed



ST-1600-HS-BR

In addition to synthetic turf, this heavy-duty rotor is designed for irrigating pastures, horse arenas, dust control, and natural turf areas.

KEY BENEFITS

- Nozzle choices: 6 (included)
- Standard nozzle: 20
- Nozzle range: 16 to 26
- Nozzle trajectory: 25°
- Isolated, grease-lubricated gear drive
- Movable stops with left and right arc adjustment
- Arc setting 40° to non-reversing 360°
- Ratcheting nozzle turret

OPERATING SPECIFICATIONS

- Radius: 107' to 165'
- Flow: 96.2 to 326.8 GPM



ST-1600-HS-BR

Overall height: 8¾"
Diameter: 8¼"
Inlet size: 2" BSP*

*Use P/N 241400SP 2" male spigot x 2" male BSP adapter if needed

ST-1600 NOZZLE PERFORMANCE DATA*

Nozzle	Pressure PSI	Radius ft.	Flow GPM	Precip in/hr	
				■	▲
16 ● Black	60	107	96.2	1.63	1.88
	70	115	107.3	1.57	1.81
	90	121	117.8	1.54	1.78
	100	128	127.3	1.50	1.73
	115	135	137.4	1.46	1.69
18 ● Black	60	112	107.0	1.66	1.91
	70	121	119.4	1.56	1.80
	90	128	131.0	1.54	1.78
	100	133	141.3	1.54	1.78
	115	141	153.2	1.48	1.71
20 ● Black	60	115	144.0	2.10	2.43
	70	128	160.9	1.89	2.18
	90	141	176.5	1.71	1.97
	100	144	190.5	1.76	2.03
	115	148	204.2	1.80	2.08
22 ● Black	60	118	171.5	2.37	2.73
	70	130	191.8	2.20	2.54
	90	144	210.0	1.94	2.24
	100	151	226.9	1.84	2.12
	115	157	243.1	1.89	2.18
24 ● Black	60	121	202.1	2.64	3.05
	70	133	225.9	2.46	2.84
	90	148	247.6	2.19	2.52
	100	156	267.4	2.12	2.45
	115	160	286.4	2.16	2.49
26 ● Black	60	126	233.2	2.83	3.27
	70	136	260.4	2.71	3.13
	90	151	284.5	2.40	2.77
	100	160	307.0	2.31	2.67
	115	165	326.8	2.32	2.68

Note:

All precipitation rates are calculated for 180° operation. For the precipitation rate of a 360° sprinkler, divide by 2.

* All radius measurements are taken at standard rotation speeds. Slowing rotation to the minimum rotation speed will add 10+ feet to the radius.

ST-1600-HS-BR Rotor Installed



ST-1600-KIT / ST-1600-HS-B

This all-in-one solution offers unmatched cleaning, cooling, and flushing capabilities to prepare synthetic sports fields for play.

KEY BENEFITS

- Nozzle choices: 6 (included)
- Standard nozzle: 20
- Nozzle range: 16 to 26
- Nozzle trajectory: 25°
- Isolated, grease-lubricated gear drive
- Movable stops (left and right) arc adjustment
- Arc setting: 40° to non-reversing 360°
- Ratcheting nozzle turret
- Adjustable speed of rotation: 0 to 65 seconds (high-speed models, 180° at 120 PSI)
- Warranty period: 5 years for component parts

OPERATING SPECIFICATIONS

- Radius: 107' to 165'
- Flow: 96.2 to 326.8 GPM
- Operating pressure range: 60 to 120 PSI
- Precipitation rate: 2.25 in/hr approximately

USER-INSTALLED OPTIONS

- Simulated concrete cover for attachment to the top of the flattened Infill Barrier System (used with vault): P/N ST-FRP-1600
- ST-approved adhesive for attaching artificial turf, track, or simulated concrete (ST-FRP-1600) to Infill Barrier System: P/N ST-ADH-K
- ST-1600 Short-Radius Nozzle Kit: P/N 959900
- Adapter (if needed), 2" male spigot x 2" male BSP: P/N 241400SP (Not for use with kit)
- DC-Latching Solenoid Kit: P/N ST-LSA



ST-1600-HS-B (High-Speed)

Overall height: 22½"
Pop-up height: 5"
Diameter: 14"
Inlet size: 2" BSP*



ST-1600 Tool

P/N 517600SP
For gear-drive installation and removal

ST-1600-KIT

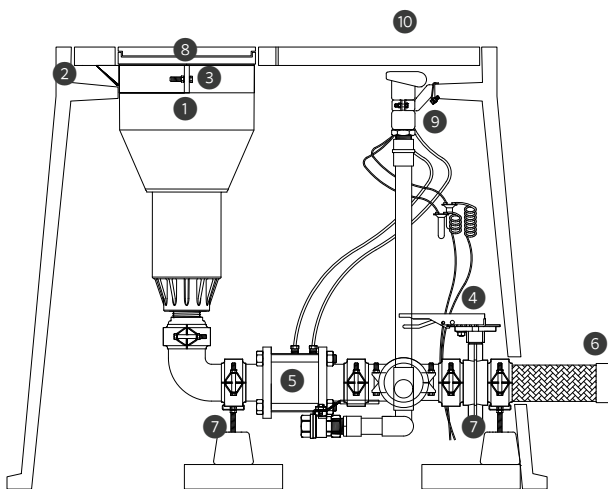

ST-1600-KIT COMPONENTS

Figure	Components	Qty	Description
1	ST-1600-HS-B	1	High-speed pop-up, adjustable arc (40° to 360°), 2" BSP inlet
2	ST-243636-B	1	Composite vault
3	ST-BKT-1600	1	Rotor vault hanger and grade adjustment bracket for ST-1600-HS-B Rotor
4	ST-BVF30-K	1	Manifold butterfly valve and Victaulic® coupling fitting kit (includes galvanized, grooved x male BSP rotor adapter fitting)
5	ST-V30-KV	1	3" metal control valve, 3" grooved Victaulic inlet/outlet fittings, solenoid, and on-off-auto selector manifold
6	ST-H30-K	1	Stainless steel inlet hose, 3" NPT inlet
7	ST-SPT-K	2	Adjustable manifold support stand; two required per vault
8	ST-IBS-1600	1	Infill Barrier System Rubber Cover Kit for ST-1600-HS-B Rotor
9	ST-BKT-QCV	1	Hanger bracket for HQ-5-RC Quick Coupler
10	HQ-5-RC	1	Quick Coupler, 1" NPT inlet, 1¼" outlet for key

Victaulic is a trademark of Victaulic Company.

ST Infill Barrier System

ST-IBS-1600
Rubber Cover Kit with Infill Barrier System.

ST Adjustable Hanger Bracket

ST-BKT-1600
This bracket supports the rotor within the vault and provides vertical elevation adjustments, allowing for a perfect surface transition.

ST Manifold and Isolation Valve

ST-BVF30-K
Galvanized iron manifold, including 3" fitting, isolation valve, and drain valve.

ST H-Block Manifold Supports

ST-SPT-K
Adjustable support stands include a large footprint base made from recycled tire rubber and a 2" vertically adjustable support rail (two required under manifold).



ST Flexible Stainless Steel Inlet Hose

ST-H30-K
3" ultra-flexible, corrugated, stainless steel hose with stainless steel support braiding.

ST Low-Loss, Slow-Opening Valve

ST-V30-KV
Heavy-duty 3" low-pressure-loss valve (2.2 PSI at 272 GPM). Includes on-off-auto selector and solenoid (not shown).

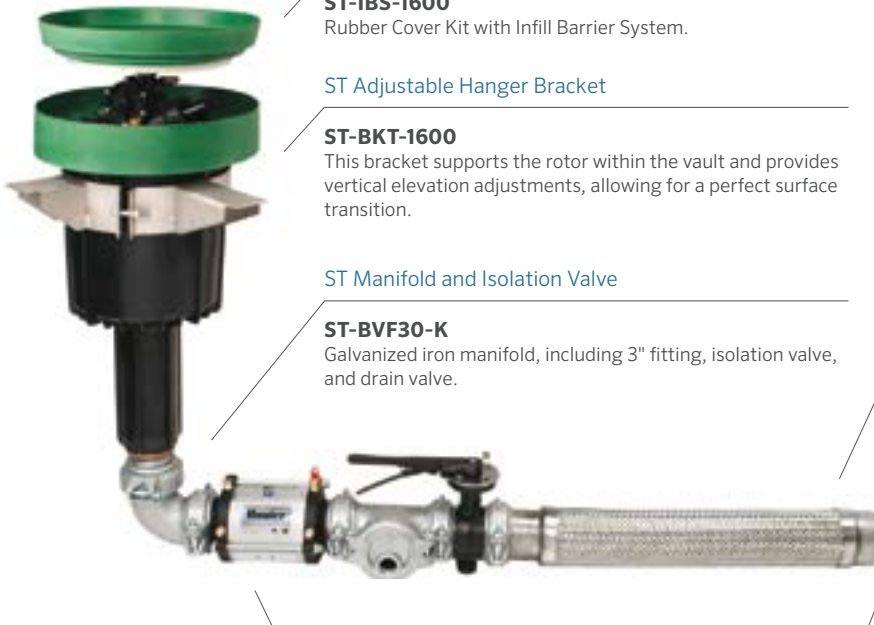

ST-1600 NOZZLE PERFORMANCE DATA*

Nozzle	Pressure PSI	Radius ft	Flow GPM	Precip in/hr	
				■	▲
16 ● Black	60	107	96.2	1.63	1.88
	70	115	107.3	1.57	1.81
	90	121	117.8	1.54	1.78
	100	128	127.3	1.50	1.73
	115	135	137.4	1.46	1.69
18 ● Black	60	112	107.0	1.66	1.91
	70	121	119.4	1.56	1.80
	90	128	131.0	1.54	1.78
	100	133	141.3	1.54	1.78
	115	141	153.2	1.48	1.71
20 ● Black	60	115	144.0	2.10	2.43
	70	128	160.9	1.89	2.18
	90	141	176.5	1.71	1.97
	100	144	190.5	1.76	2.03
	115	148	204.2	1.80	2.08
22 ● Black	60	118	171.5	2.37	2.73
	70	130	191.8	2.20	2.54
	90	144	210.0	1.94	2.24
	100	151	226.9	1.84	2.12
	115	157	243.1	1.89	2.18
24 ● Black	60	121	202.1	2.64	3.05
	70	133	225.9	2.46	2.84
	90	148	247.6	2.19	2.52
	100	156	267.4	2.12	2.45
	115	160	286.4	2.16	2.49
26 ● Black	60	126	233.2	2.83	3.27
	70	136	260.4	2.71	3.13
	90	151	284.5	2.40	2.77
	100	160	307.0	2.31	2.67
	115	165	326.8	2.32	2.68

Note:

All precipitation rates are calculated for 180° operation. For the precipitation rate of a 360° sprinkler, divide by 2.
* All radius measurements are taken at standard rotation speeds. Slowing rotation to the minimum rotation speed will add 10+ feet to the radius.

SEAMLESS INTEGRATION

Blends in perfectly with the surrounding synthetic surface.



ST VAULTS

The heavy-duty, tapered fiberglass and polymer-concrete construction includes precast holes for the rotor, quick coupler valve, and remote manifold assembly.

Quick Couplers provide a convenient source of water for washing down spills and water-soluble paint. The integrated in-vault design eliminates the need for additional quick coupler enclosures.

The ST-V30-KV Valve Kit includes a remotely located on-off-auto selector and solenoid manifold assembly. These convenient features bring valve manual control functions and solenoid splice connections closer to the surface for easy access.

ST-243636-B: Includes 3" thick, 4-piece PC cover set

Main cover: 24" x 36"
Overall height: 36"
Body weight: 170 lb
Total weight: 320 lb
Base pad: 42" x 48"
Quick-access ports: 2



STG-900-KIT / STG-900

This top-quality, long-range system is specially designed for synthetic turf sports field irrigation.

KEY BENEFITS

- Arc setting: 40° to 360°
- QuickCheck™ Arc Mechanism
- Through-the-top arc adjustment
- Water-lubricated gear drive
- Factory-installed rubber logo cap
- Nozzle trajectory: 22.5°
- Warranty period: 5 years for component parts

OPERATING SPECIFICATIONS

- Radius: 103' to 120'
- Flow: 74.5 to 92.0 GPM
- Operating pressure range: 100 to 120 PSI
- Precipitation rate: 1.25 in/hr approximately

USER-INSTALLED OPTIONS

- Rubber Cover Kit STG-900: P/N 473900SP



STG-900*

Overall height: 14"
Pop-up height: 3"
Diameter: 8"
Inlet size: 1½" Acme

*For use with the ST-173026-B Vault

STG-900-KIT

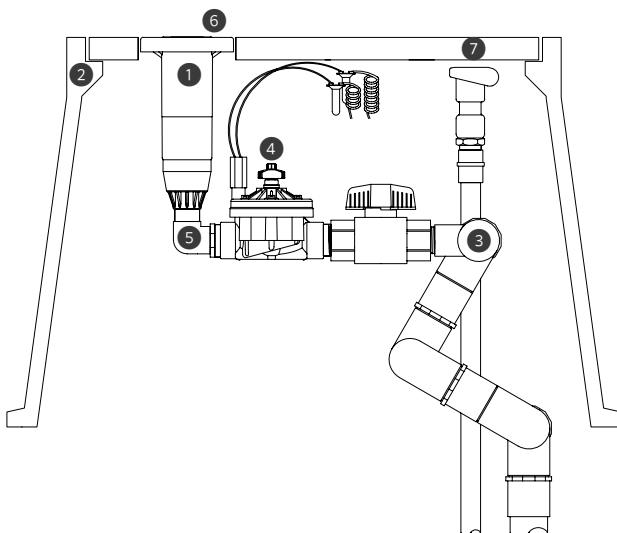

STG-900-KIT COMPONENTS

FIGURE	COMPONENTS	QTY	DESCRIPTION
1	STG-900-83	1	Pop-up, top serviceable, adjustable arc (40°-360°), 1½" Acme inlet
2	ST-173026-B	1	Composite vault, pre-cast hole for rotor and quick coupler
3	ST-2008-VA	1	Vertical alignment PVC swing joint, seven pivot points, 2" female slip inlet, 1½" female Acme outlet
4	ST-VBVF-K	1	ICV-151G valve, manifold ball valve, 1½" Acme inlet, 1½" Acme outlet
5	239800	1	1½" elbow, female Acme to male Acme, connects STG-900 rotor to ST-VBVF-K
6	473900SP	1	STG-900 rubber cover kit
7	HQ-5RC	1	Quick coupler, 1" NPT inlet, 1¼" outlet for key

STG-900 Rotor



STG-900 NOZZLE PERFORMANCE DATA

Nozzle	Pressure PSI	Radius ft.	Flow GPM	Precip in/hr	
				■	▲
73 ●	100	103	74.5	1.35	1.56
	110	109	77.0	1.25	1.44
Orange	120	115	79.6	1.16	1.34
83 ●	100	112	84.2	1.29	1.49
	110	116	88.1	1.26	1.46
Tan	120	120	92.0	1.23	1.42

Notes:

All precipitation rates are calculated for 180° operation.
For the precipitation rate of a 360° sprinkler, divide by 2.

ST SWING JOINTS

Multiaxis 315 PSI rated vertical alignment PVC swing joints with seven O-ring sealed pivot points allow the rotor to be perfectly placed within the ST Vault's cover set opening.

ST-2008-VA: 2" for STG-900-KIT

Inlet: 2" female slip
Outlet: 1½" female Acme

Adapter fitting 239300
Connects 239800 elbow fitting to STG-900 Acme inlet rotor



ST VALVE SETS

Heavy-duty control valves are configured to complement the ST Rotors and ST Vaults.

ST-VBVF-K: for STG-900-KIT

Valve: 1½" NPT ICV
Ball valve: 315 PSI rated
Inlet: 1½" Acme
Outlet: 1½" Acme
Low-pressure-loss design: 9.8 PSI at 100 GPM
Includes: 1½" connection fittings



ST VAULTS

Heavy-duty tapered fiberglass and polymer-concrete construction with pre-cast holes for rotor and quick-coupler valve.

ST-173026-B for STG-900-KIT includes 2" thick, 3-piece cover set

Main cover: 17" x 30"
Overall height: 26"
Body weight: 104 lbs.
Total weight: 161 lbs.
Base pad: 27" x 41"
Quick-access port: 1



① Quick Coupler

All ST Vaults include convenient quick-access ports. Quick couplers provide a convenient source of water for washing down spills and water-soluble paint. The integrated in-vault design eliminates the need for additional quick-coupler enclosures.

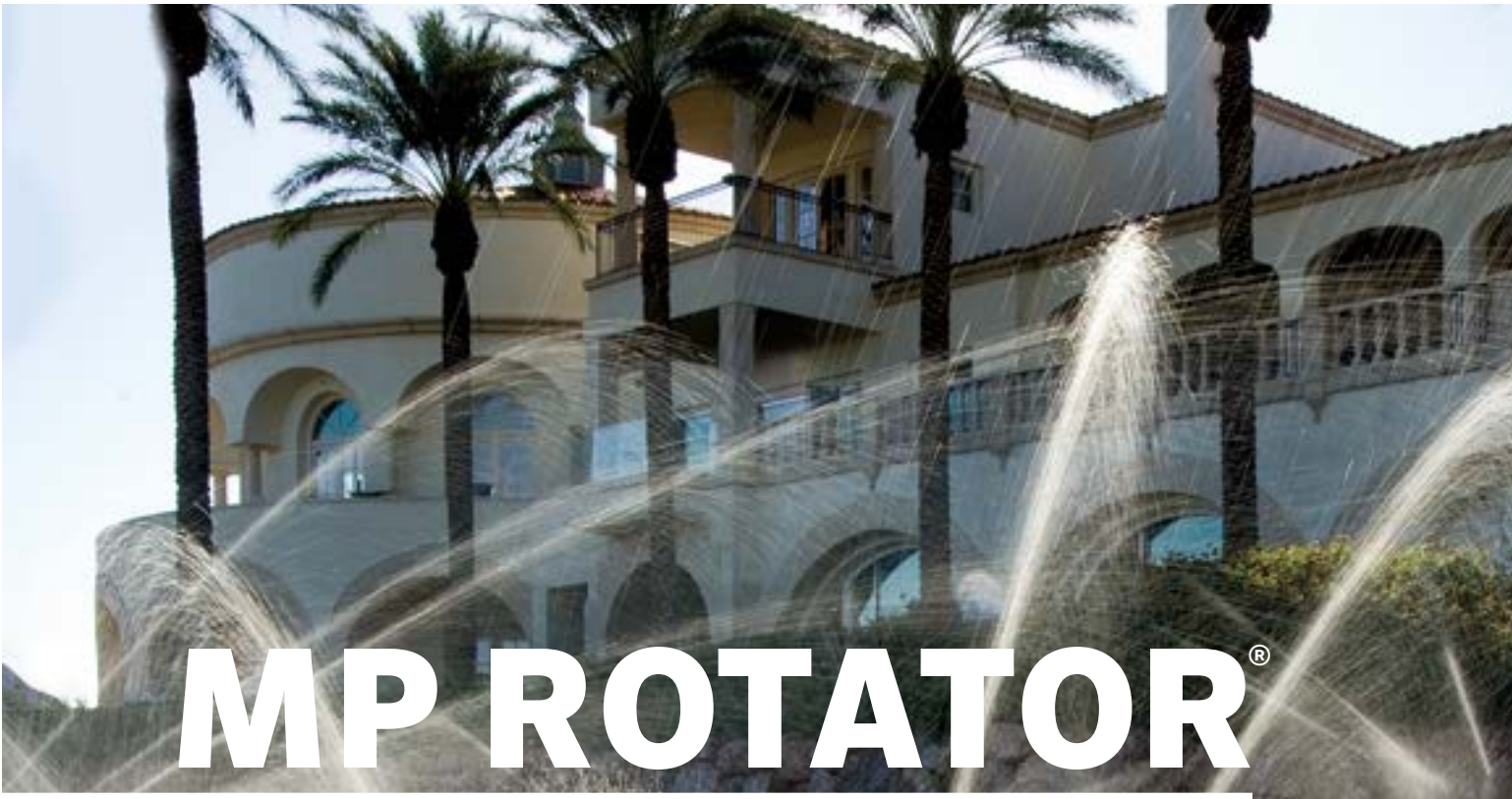

MP ROTATOR®





ADVANCED FEATURES

AUTOMATIC MATCHED PRECIPITATION

MP Rotator Nozzles adjust the flow rate through the nozzle as the radius and arc are changed, resulting in the same matched precipitation rate regardless of the nozzle setting.

DOUBLE-POP FEATURE

MP Rotator Nozzles pop up from their protected position only after the riser is fully extended, providing superior defense against dirt and debris.



HIGH DISTRIBUTION UNIFORMITY

The multiple streams of the MP Rotator Nozzle target all areas of the landscape evenly, resulting in superior uniformity over traditional spray nozzles and better wind resistance.

LOW PRECIPITATION RATE

Since the majority of soils have a water infiltration rate of less than 1.0 in/hr, irrigating at a low precipitation rate is essential to reduce runoff and increase efficiency.

The Standard MP Rotator Nozzle applies water at 0.4 in/hr, while the MP800 Nozzle has a precipitation rate of 0.8 in/hr. Either choice will avoid runoff, save water, and prevent erosion.

STANDARD
MP Rotator Nozzles

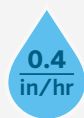

- 8' to 35'**
- Maximum water efficiency
 - Slowest precipitation rate

MP ROTATOR
MP800 Nozzles

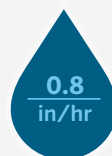

- 6' to 16'**
- Small spaces
 - Tight water windows

MP ROTATOR
Strip Nozzles



- 5' wide**
- Rectangular spaces
 - Pair with either option

STANDARD MP ROTATOR®

Radius: 8' to 35'

0.4
in/hr

The MP Rotator Nozzle is the most trusted high-efficiency solution on the market, offering up to 30% water savings over traditional spray nozzles.

KEY BENEFITS

- Low precipitation rate of approximately 0.4 in/hr — lowest in the industry
- Automatic matched precipitation for simplified irrigation design and flexibility
- Double-pop feature protects the nozzle from external debris
- High distribution uniformity for a healthy landscape with maximum water efficiency

ADDITIONAL FEATURES

- Wind-resistant, multi-stream technology prevents misting
- For vandal resistance, the arc is adjustable only when the MP Rotator Nozzle is running
- Removable filter screen prevents nozzle from clogging
- Color-coded for easy identification

OPERATING SPECIFICATIONS

- Radius reduction up to approximately 25% on all models
- Recommended operating pressure: 40 PSI
- Minimum radius setting achieved at 30 PSI
- Warranty period: 3 years

OPTIONS

- Pair with Pro-Spray® PRS40 Sprinkler Body for pressure regulation to 40 PSI for nominal radius settings
- Pair with Pro-Spray PRS30 Sprinkler Body for pressure regulation to 30 PSI for minimum radius settings

MP1000: 8' to 15' radius



MP1000-90
90° to 210°



MP1000-210
210° to 270°



MP1000-360
360°

MP2000: 13' to 21' radius



MP2000-90
90° to 210°



MP2000-210
210° to 270°



MP2000-360
360°

MP3000: 22' to 30' radius



MP3000-90
90° to 210°



MP3000-210
210° to 270°



MP3000-360
360°

MP3500: 31' to 35' radius



MP3500-90
90° to 210°

MP ROTATOR - SPECIFICATION BUILDER: ORDER 1 + 2

1 Model	2 Options
MP1000-90 = 8' to 15' radius, adjustable from 90° to 210°	(blank) = No option HT = Male threaded version <i>(Not available in 3500 and 1000-210)</i>
MP1000-210 = 8' to 15' radius, adjustable from 210° to 270°	
MP1000-360 = 8' to 15' radius, 360°	
MP2000-90 = 13' to 21' radius, adjustable from 90° to 210°	
MP2000-210 = 13' to 21' radius, adjustable from 210° to 270°	
MP2000-360 = 13' to 21' radius, 360°	
MP3000-90 = 22' to 30' radius, adjustable from 90° to 210°	
MP3000-210 = 22' to 30' radius, adjustable from 210° to 270°	
MP3000-360 = 22' to 30' radius, 360°	
MP3500-90 = 31' to 35' radius, adjustable from 90° to 210°	
MPLCS-515 = Left corner strip, 5' x 15'	
MPRCS-515 = Right corner strip, 5' x 15'	
MPSS-530 = Side strip, 5' x 30'	
MP-CORNER = 8' to 15' radius, adjustable from 45° to 105°	

MP ROTATOR PERFORMANCE DATA

Arc	Pressure PSI	MP1000 Radius: 8' to 15' Adjustable Arc and Full-Circle					MP2000 Radius: 13' to 21' Adjustable Arc and Full-Circle					MP3000 Radius: 22' to 30' Adjustable Arc and Full-Circle				
		Radius ft.	Flow GPM	Flow GPH	Precip in/hr ■ ▲	Radius ft.	Flow GPM	Flow GPH	Precip in/hr ■ ▲	Radius ft.	Flow GPM	Flow GPH	Precip in/hr ■ ▲			
90° 	30	12	0.17	10.2	0.45	0.52	18	0.38	22.8	0.45	0.52	27	0.76	45.6	0.40	0.46
	35	13	0.19	11.4	0.43	0.50	19	0.40	24.0	0.43	0.49	28	0.82	49.2	0.40	0.46
	40	14	0.21	12.6	0.41	0.48	20	0.43	25.8	0.41	0.48	30	0.86	51.6	0.37	0.42
	45	14	0.23	13.8	0.45	0.52	21	0.46	27.6	0.40	0.46	30	0.90	54.0	0.39	0.44
	50	15	0.25	15.0	0.43	0.49	21	0.47	28.2	0.41	0.47	30	0.95	57.0	0.41	0.47
180° 	30	12	0.34	20.4	0.45	0.52	17	0.64	38.4	0.43	0.49	27	1.58	94.8	0.42	0.48
	35	13	0.38	22.8	0.43	0.50	18	0.71	42.6	0.42	0.49	28	1.70	102.0	0.42	0.48
	40	14	0.42	25.2	0.41	0.48	19	0.77	46.2	0.41	0.47	30	1.82	109.2	0.39	0.45
	45	14	0.44	26.4	0.43	0.50	20	0.85	51.0	0.41	0.47	30	1.93	115.8	0.41	0.48
	50	15	0.50	30.0	0.43	0.49	21	0.91	54.6	0.40	0.46	30	2.04	122.4	0.44	0.50
210° 	30	12	0.40	24.0	0.46	0.53	17	0.75	45.0	0.43	0.49	27	1.84	110.4	0.42	0.48
	35	13	0.45	27.0	0.44	0.51	18	0.81	48.6	0.41	0.48	28	1.99	119.4	0.42	0.48
	40	14	0.49	29.4	0.41	0.48	19	0.86	51.6	0.39	0.45	30	2.12	127.2	0.39	0.45
	45	14	0.51	30.6	0.43	0.50	20	0.91	54.6	0.38	0.43	30	2.25	135.0	0.41	0.48
	50	15	0.57	34.2	0.42	0.48	21	0.98	58.8	0.37	0.42	30	2.37	142.2	0.43	0.50
270° 	30	12	0.48	28.8	0.43	0.49	17	0.95	57.0	0.42	0.49	27	2.37	142.2	0.42	0.48
	35	13	0.53	31.8	0.40	0.46	18	1.03	61.8	0.41	0.47	28	2.55	153.0	0.42	0.48
	40	14	0.63	37.8	0.41	0.48	19	1.10	66.0	0.39	0.45	30	2.73	163.8	0.39	0.45
	45	14	0.67	40.2	0.44	0.51	20	1.17	70.2	0.38	0.43	30	2.89	173.4	0.41	0.48
	50	15	0.72	43.2	0.41	0.47	21	1.23	73.8	0.36	0.41	30	3.06	183.6	0.44	0.50
360° 	30	12	0.69	41.4	0.46	0.53	17	1.28	76.8	0.43	0.49	27	3.15	189.0	0.42	0.48
	35	13	0.77	46.2	0.44	0.51	18	1.37	82.2	0.41	0.47	28	3.40	204.0	0.42	0.48
	40	14	0.84	50.4	0.41	0.48	19	1.48	88.8	0.39	0.46	30	3.64	218.4	0.39	0.45
	45	14	0.88	52.8	0.43	0.50	20	1.57	94.2	0.38	0.44	30	3.86	231.6	0.41	0.48
	50	15	0.98	58.8	0.42	0.48	21	1.68	100.8	0.37	0.42	30	4.07	244.2	0.44	0.50
	55	15	1.01	60.6	0.43	0.50	21	1.74	104.4	0.38	0.44	30	4.27	256.2	0.46	0.53

Bold = Optimal pressure for the MP Rotator Nozzle is 40 PSI. This can easily be achieved by using it with the Hunter pressure-regulated Pro-Spray PRS40 Sprinkler Body at 40 PSI.

Works best with Pro-Spray PRS40



Compatible with:



Pro-Spray PRS40
Page 60



MP ROTATOR PERFORMANCE DATA

MP3500

Radius: 31' to 35'

Adjustable Arc

● Light Brown: 90° to 210°

Arc	Pressure PSI	Radius ft.	Flow GPM	Flow GPH	Precip in/hr	
					■	▲
90° 	30	34	1.13	67.8	0.38	0.43
	35	34	1.21	72.6	0.40	0.47
	40	35	1.28	76.8	0.40	0.46
	45	35	1.38	82.8	0.43	0.50
	50	35	1.43	85.8	0.45	0.52
180° 	30	34	2.24	134.4	0.37	0.43
	35	34	2.65	159.0	0.44	0.51
	40	35	2.86	171.6	0.45	0.52
	45	35	3.10	186.0	0.49	0.56
	50	35	3.21	192.6	0.50	0.58
210° 	30	34	2.84	170.4	0.41	0.47
	35	34	3.08	184.8	0.44	0.51
	40	35	3.29	197.4	0.44	0.51
	45	35	3.54	212.4	0.48	0.55
	50	35	3.76	225.6	0.51	0.59
55	35	3.94	236.4	0.53	0.61	



Bold = Optimal pressure for the MP Rotator Nozzle is 40 PSI. This can easily be achieved by using it with the pressure-regulated Pro-Spray PRS40 Sprinkler Body at 40 PSI.

MP3500



MP ROTATOR PERFORMANCE DATA

- **MPLCS-515**: Ivory, MP Left Corner Strip
- **MPRCS-515**: Copper, MP Right Corner Strip
- **MPSS-530**: Brown, MP Side Strip

	Pressure PSI	Radius ft.	Flow GPM	Flow GPH	Precip in/hr	
					■	▲
MP Left Corner Strip 	30	4 x 14	0.17	10.2	1.17	0.58
	35	5 x 15	0.18	10.8	0.92	0.46
	40	5 x 15	0.19	11.4	0.98	0.49
	45	5 x 15	0.21	12.6	1.08	0.54
	50	5 x 16	0.23	13.8	1.11	0.55
MP Right Corner Strip 	30	4 x 14	0.17	10.2	1.17	0.58
	35	5 x 15	0.18	10.8	0.92	0.46
	40	5 x 15	0.19	11.4	0.98	0.49
	45	5 x 15	0.21	12.6	1.08	0.54
	50	5 x 16	0.23	13.8	1.11	0.55
MP Side Strip 	30	4 x 28	0.33	19.8	1.13	0.57
	35	5 x 29	0.36	21.6	0.96	0.48
	40	5 x 30	0.38	22.8	0.98	0.49
	45	5 x 31	0.41	24.6	1.02	0.51
	50	6 x 32	0.44	26.4	0.88	0.44
55	6 x 33	0.47	38.4	0.92	0.46	

MP Rotator Strip Nozzles



MPLCS-515
Left Corner Strip
5' x 15'



MPRCS-515
Right Corner Strip
5' x 15'



MPSS-530
Side Strip
5' x 30'



Bold = Recommended pressure

Note: To match the precipitation rate of Standard MP Rotator models, use single-row or triangular spacing. To match the precipitation rate of MP Rotator MP800 Nozzles, use rectangular spacing..

See **page 190** for precipitation rate calculation.



MP ROTATOR PERFORMANCE DATA

MP Corner

Radius: 8' to 15'

Adjustable Arc

● Turquoise: 45° to 105°

Arc	Pressure PSI	Radius ft.	Flow GPM	Flow GPH
45° 	30	12	0.17	10.2
	35	13	0.18	10.8
	40	14	0.19	11.4
	45	14	0.21	12.6
	50	14	0.22	13.2
90° 	30	12	0.34	20.4
	35	13	0.36	21.6
	40	14	0.39	23.4
	45	14	0.41	24.6
	50	15	0.43	25.8
105° 	30	12	0.39	23.4
	35	13	0.42	25.2
	40	14	0.45	27.0
	45	14	0.48	28.8
	50	15	0.51	30.6
	55	15	0.53	31.8

Bold = Recommended pressure

MP Corner



MP-CORNER

Corner
8' to 15'

Male Threaded



MP-HT

Male Threaded

MP Accessories



MPTOOL

Adjusts all MP Rotator
Nozzles



MPSTICK

Snaps onto any length of
1" PVC to allow standing
adjustment. *PVC pipe not
included.*

MP Corner



MP Tool for easy adjustments



MP ROTATOR® MP800

The MP800 offers a higher precipitation rate perfect for small spaces and spray retrofits.

Radius: 6' to 16'

0.8
in/hr

KEY BENEFITS

- Precipitation rate of approximately 0.8 in/hr for spray retrofit applications
- Automatic matched precipitation for simplified irrigation design and flexibility
- Double-pop feature protects the nozzle from external debris
- High distribution uniformity for a healthy landscape with maximum water efficiency

ADDITIONAL FEATURES

- Wind-resistant, multi-stream technology prevents misting
- For vandal resistance, the arc is adjustable only when the MP Rotator Nozzle is running
- Removable filter screen prevents nozzle clogging
- Color-coded for easy identification

OPERATING SPECIFICATIONS

- Radius reduction up to approximately 25% on all models
- Recommended operating pressure: 40 PSI
- Minimum radius setting achieved at 30 PSI
- Filtration recommended on dirty water applications
- Warranty period: 3 years

OPTIONS

- Pair with Pro-Spray® PRS40 Sprinkler Body for pressure regulation to 40 PSI for nominal radius settings
- Pair with Pro-Spray PRS30 Sprinkler Body for pressure regulation to 30 PSI for minimum radius settings

MP800SR: 6' to 12' radius



MP800SR-90
90° to 210°



MP800SR-360
360°

MP815: 8' to 16' radius



MP815-90
90° to 210°



MP815-210
210° to 270°



MP815-360
360°

Compatible with:



HY Filter
Page 157



PRS30 and PRS40
Page 58 and Page 60

MP800SR-90



MP815-90



MP ROTATOR PERFORMANCE DATA





MP800SR

Radius: 6' to 12'

Adjustable Arc and Full-Circle

● Orange and Gray: 90° to 210°

● Lime Green and Gray: 360°

MAX RADIUS							MIN RADIUS	
Arc	Pressure PSI	Radius ft.	Flow		Precip in/hr		Radius ft.	Flow GPM
			GPM	GPH	■	▲		
90° 	30	8	0.17	9.6	0.90	1.04	6	0.13
	35	9	0.21	11.4	0.89	1.03	7	0.15
	40	10	0.23	13.8	0.83	0.96	8	0.16
	45	11	0.25	15.0	0.80	0.92	8	0.18
	50	11	0.27	16.2	0.79	0.92	9	0.19
	55	12	0.28	16.8	0.80	0.93	10	0.20
180° 	30	8	0.33	19.2	0.88	1.02	6	0.26
	35	9	0.38	22.2	0.85	0.99	7	0.29
	40	10	0.42	25.2	0.81	0.93	8	0.32
	45	11	0.46	27.6	0.77	0.88	8	0.36
	50	11	0.48	28.8	0.76	0.88	9	0.38
	55	12	0.50	30.0	0.73	0.84	10	0.40
210° 	30	8	0.35	22.2	0.80	0.93	6	0.30
	35	9	0.38	26.4	0.77	0.89	7	0.34
	40	10	0.43	29.4	0.81	0.91	8	0.37
	45	10	0.45	31.8	0.82	0.95	8	0.42
	50	11	0.49	33.6	0.73	0.85	9	0.44
	55	12	0.56	34.8	0.70	0.81	10	0.47
360° 	30	8	0.66	37.8	0.89	1.03	6	0.47
	35	9	0.71	42.0	0.80	0.92	7	0.52
	40	10	0.78	46.8	0.79	0.91	8	0.56
	45	10	0.85	51.0	0.78	0.90	8	0.59
	50	11	0.88	52.8	0.73	0.85	9	0.63
	55	12	0.98	58.8	0.70	0.81	10	0.70

Bold = Optimal pressure for the MP Rotator Nozzle is 40 PSI. This can easily be achieved by using it with the pressure-regulated Pro-Spray PRS40 Sprinkler Body at 40 PSI.

MP ROTATOR PERFORMANCE DATA

MP815





Radius: 8' to 16'

Adjustable Arc and Full-Circle

● Maroon and Gray: 90° to 210°

● Lt. Blue and Gray: 210° to 270°

● Olive and Gray: 360°

Arc	Pressure PSI	Radius ft.	Flow		Precip in/hr	
			GPM	GPH	■	▲
90° 	30	14	0.42	25.2	0.83	0.95
	35	15	0.46	27.6	0.79	0.91
	40	15	0.49	29.4	0.84	0.97
	45	16	0.52	31.2	0.78	0.90
	50	16	0.55	33.0	0.83	0.96
	55	16	0.58	34.8	0.87	1.01
180° 	30	13	0.75	45.0	0.85	0.99
	35	14	0.86	51.6	0.84	0.98
	40	15	0.93	55.8	0.80	0.92
	45	15	0.96	57.6	0.82	0.95
	50	16	1.06	63.6	0.80	0.92
	55	16	1.11	66.6	0.83	0.96
210° 	30	13	0.88	52.8	0.86	0.99
	35	14	0.96	57.6	0.81	0.93
	40	15	1.10	66.0	0.81	0.93
	45	15	1.16	69.6	0.85	0.98
	50	16	1.24	74.4	0.80	0.92
	55	16	1.30	78.0	0.84	0.97
270° 	30	13	1.14	68.4	0.87	1.00
	35	14	1.24	74.4	0.81	0.94
	40	15	1.40	84.0	0.80	0.92
	45	15	1.47	88.2	0.84	0.97
	50	16	1.54	92.4	0.77	0.89
	55	16	1.61	96.6	0.81	0.93
360° 	30	13	1.52	91.2	0.87	1.00
	35	14	1.70	102.0	0.83	0.96
	40	15	1.87	112.2	0.80	0.92
	45	15	2.00	120.0	0.86	0.99
	50	16	2.13	127.8	0.80	0.92
	55	16	2.26	135.6	0.85	0.98

MP ROTATOR STAKE KIT

Models: **Standard and Pressure-Regulated Staking Kits**

Designed for easy implementation with any water-efficient MP Rotator Nozzle, MP Stake Kits come preassembled for quick installation in the field.

KEY BENEFITS

- Pair with any high-efficiency MP Rotator Nozzle to simplify temporary irrigation
- Preassembled for fast and easy installation in the field
- Standard kit includes a 26" stake, nozzle adapter, 0.345" tubing, and ½" threaded male fitting for quick connection
- For maximum water savings, upgrade to a 40 PSI pressure regulator and Hunter Check Valve

OPERATING SPECIFICATIONS

- Operational pressure range: 30 to 70 PSI

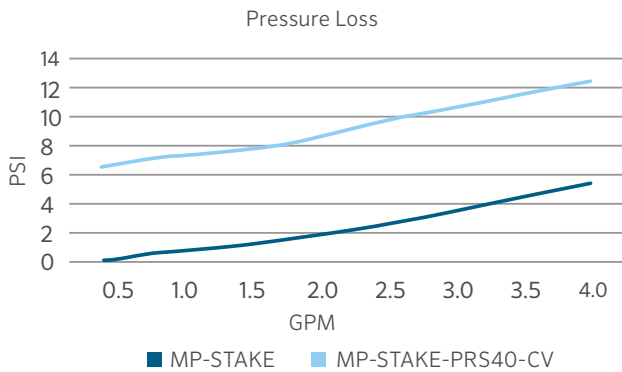

MP-STAKE
Total height: 28"
Male threaded connection: ½"

MP-STAKE-PRS40-CV
Total height: 34"
Male threaded connection: ½"

Compatible with:



All MP Rotator Nozzles
Page 42 and Page 46



Spray Nozzles
Page 63

MP-STAKE-PRS40-CV Installation



MP-STAKE MODELS

Model	Description
MP-STAKE	26" stake, 0.345" tubing to ½" male fitting, PROS-00 shrub adapter (total height: 28")
MP-STAKE-PRS40-CV	26" stake, 0.345" tubing to ½" male fitting, Hunter Check Valve, PROS-00-PRS40 pressure-regulated shrub adapter (total height: 34")



ENGINEERED FOR *MAXIMUM EFFICIENCY*

DURABLE

With only one moving part, the MP Rotator is built with the highest-quality materials to ensure long-lasting performance in every installation.

FLEXIBLE

Matched precipitation across 5' wide strips to 35' radius allows the MP Rotator to fit a wide range of landscapes with uniform coverage for healthy plants.

EFFICIENT

The rotating streams of water cut through wind, reduce misting, and distribute water at a slow, even rate that soils can better absorb, preventing runoff.

RELIABLE

With more than 15 years of proven performance with Hunter Industries, the MP Rotator is the most trusted high-efficiency nozzle on the market.

SPRAY SPRINKLER BODIES

SPRAY SPRINKLER BODIES





SPRAY SPRINKLER BODY

ADVANCED FEATURES



CO-MOLDED WIPER SEAL

Molded with two types of chemical- and chlorine-resistant materials, this multi-function wiper seal reduces flow-by, allowing more heads on one zone, and prevents debris from entering the seal, reducing riser stick-ups.

FLOGUARD™ TECHNOLOGY



In the event of a missing nozzle, FloGuard Technology reduces the flow of water from the riser to a 0.5 GPM (10' tall) indicator stream, eliminating water waste and preventing landscape erosion while providing a visual indicator for repair.



HEAVY-DUTY SPRING

The industry's strongest spring offers positive retraction under any conditions.



CHECK VALVE

Optional field- or factory-installed check valves eliminate leaks and puddles at the lower heads, protecting landscapes from damage and erosion while reducing water waste.



PRESSURE REGULATION

Pressure-regulated Pro-Spray® Sprinkler Bodies optimize the performance of the nozzle, reducing flow rates and preventing misting. The brown PRS30 model regulates pressures to 30 PSI for spray nozzles. The gray PRS40 model regulates pressures to 40 PSI when paired with the efficient MP Rotator Nozzle.

INDUSTRY'S STRONGEST SPRAY BODY



The Pro-Spray line incorporates a heavy-duty ribbed body and durable cap engineered to withstand the harshest environments, including the rigors of foot traffic and the abuses of heavy machinery. In addition, the buttress thread design provides superior strength in cap-to-body gripping capacity, helping the head to withstand high inlet surge pressures.

PRO-SPRAY



COMPETITOR







INNOVATIVE SEAL DESIGN

Pedestrian traffic, landscape equipment, temperature changes, and cycling pressures can cause body caps to loosen. Pro-Spray caps can withstand more than one full 360° turn and remain sealed at any pressure, preventing excess runoff.

Pro-Spray: Seal remains intact

Competitor: Significant leaking at the body cap

SPRAY SPRINKLER BODY COMPARISON CHART

QUICK SPECS		 PS ULTRA	 PRO-SPRAY®	 PRO-SPRAY PRS30	 PRO-SPRAY PRS40
		Good	Better	Best for Spray Nozzles	Best for MP Rotator® Nozzles
POP-UP HEIGHT	in.	2, 4, 6	Shrub, 2, 3, 4, 6, 12	Shrub, 3, 4, 6, 12	Shrub, 3, 4, 6, 12
PRESSURE-REGULATED	PSI	N/A	N/A	30	40
FEATURES					
PREINSTALLED NOZZLE		5SS, 8A, 10A, 12A, 15A, 17A	N/A	N/A	N/A
CAP COLOR		Black	Black	Brown	Gray
CHECK VALVES		Field-Installed	Field-Installed or Factory-Installed	Field-Installed or Factory-Installed	Field-Installed or Factory-Installed
WARRANTY		2 Years	5 Years	5 Years	5 Years
ADVANCED FEATURES					
BODY STYLE		Slim Line	Rugged Body	Rugged Body	Rugged Body
SPRING		Standard	Heavy-Duty	Heavy-Duty	Heavy-Duty
CO-MOLDED WIPER SEAL			●	●	●
RECLAIMED CAP			●	●	●
PRESSURE REGULATION				●	●
FLOGUARD™ TECHNOLOGY				●	●
EPA WATERSENSE CERTIFIED				●	●
APPLICATIONS					
TURFGRASS		●	●	●	●
TURFGRASS: TALL MOWING HEIGHT		●	●	●	●
SHRUBS: SPRINKLERS ON RISERS			●	●	●
SHRUBS: TALL POP-UP SPRINKLERS			●	●	●
RESIDENTIAL		●	●	●	●
COMMERCIAL/MUNICIPALITIES			●	●	●
HIGH-TRAFFIC AREAS			●	●	●
RECLAIMED WATER			●	●	●

PS ULTRA

The PS Ultra is a compact, slim-line spray sprinkler with the option of preinstalled nozzles for faster installation.

KEY BENEFITS

- Enhanced cap for more durability, easier handling, and extended riser seal life
- Large inlet filter screen for increased debris resistance
- Check valve option eliminates low-head drainage
- Heavy-duty spring for consistent riser retraction

ADDITIONAL FEATURES

- Directional flush plug design for cleaner installation
- Two-piece ratcheting riser
- 2" and 4" models can retrofit into older style PS models
- Compatible with all female-threaded nozzles

OPERATING SPECIFICATIONS

- Operational pressure range: 20 to 70 PSI
- Warranty period: 2 years

FACTORY-INSTALLED OPTIONS

- Flush plug (large filter screen not included)
- Nozzles 8A, 10A, 12A, 15A, 5' x 30' side strip
- Large inlet filter screen included in 4" and 6" preinstalled nozzle models

USER-INSTALLED OPTIONS

- Check valve installs in filter screen for 4" and 6" models (up to 7' of elevation; P/N 462237SP)
- Large inlet filter screen (P/N 162900SP)
- Shutoff nozzle (P/N 916400SP)



PSU-02

Retracted height: 5"
Pop-up height: 2"
Exposed diameter: 1/4"
Inlet size: 1/2"



PSU-04

Retracted height: 7 1/4"
Pop-up height: 4"
Exposed diameter: 1/4"
Inlet size: 1/2"



PSU-06

Retracted height: 9 1/2"
Pop-up height: 6"
Exposed diameter: 1/4"
Inlet size: 1/2"

PS ULTRA - SPECIFICATION BUILDER: ORDER 1 + 2

1 Model	2 Nozzles
PSU-02 = 2" pop-up	(blank) = Flush plug, no large filter screen
PSU-04 = 4" pop-up	8A = 8' adjustable nozzle
PSU-06 = 6" pop-up	10A = 10' adjustable nozzle
	12A = 12' adjustable nozzle
	15A = 15' adjustable nozzle
	17A = 17' adjustable nozzle
	5SS = 5' x 30' side strip (2" and 4" only)







Examples:

- PSU-02 - 5SS = 2" pop-up, with a 5' x 30' side strip
- PSU-06 - 10A = 6" pop-up, with a 10' adjustable nozzle
- PSU-04 = 4" pop-up, with flush plug, large filter screen not included

PS ULTRA STANDARD NOZZLES PERFORMANCE DATA													
Arc	Pressure PSI	8A ● Brown 8' radius Adjustable from 0° to 360° Trajectory: 15°			10A ● Red 10' radius Adjustable from 0° to 360° Trajectory: 15°			12A ● Green 12' radius Adjustable from 0° to 360° Trajectory: 28°					
		Radius ft.	Flow GPM	Precip in/hr ■ ▲	Radius ft.	Flow GPM	Precip in/hr ■ ▲	Radius ft.	Flow GPM	Precip in/hr ■ ▲			
45° ▶	20	7	0.18	2.83	3.27	9	0.20	1.90	2.20	11	0.25	1.59	1.84
	25	8	0.20	2.74	3.16	10	0.23	1.92	2.22	12	0.28	1.60	1.85
	30	8	0.22	2.65	3.06	10	0.25	1.93	2.22	12	0.32	1.68	1.95
	35	9	0.24	2.50	2.89	11	0.28	1.92	2.22	13	0.37	1.80	2.08
	40	9	0.25	2.38	2.74	11	0.30	1.88	2.17	13	0.42	1.91	2.21
90° ◑	20	7	0.36	2.83	3.27	9	0.40	1.90	2.20	11	0.50	1.59	1.84
	25	8	0.40	2.74	3.16	10	0.45	1.92	2.22	12	0.55	1.60	1.85
	30	8	0.44	2.65	3.06	10	0.50	1.93	2.22	12	0.63	1.68	1.95
	35	9	0.47	2.50	2.89	11	0.55	1.92	2.22	13	0.73	1.80	2.08
	40	9	0.50	2.38	2.74	11	0.59	1.88	2.17	13	0.84	1.91	2.21
120° ◐	20	7	0.48	2.83	3.27	9	0.53	1.90	2.20	11	0.67	1.59	1.84
	25	8	0.53	2.74	3.16	10	0.60	1.92	2.22	12	0.73	1.60	1.85
	30	8	0.59	2.65	3.06	10	0.67	1.93	2.22	12	0.84	1.68	1.95
	35	9	0.63	2.50	2.89	11	0.73	1.92	2.22	13	0.97	1.80	2.08
	40	9	0.67	2.38	2.74	11	0.79	1.88	2.17	13	1.12	1.91	2.21
180° ◕	20	7	0.72	2.83	3.27	9	0.80	1.90	2.20	11	1.00	1.59	1.84
	25	8	0.80	2.74	3.16	10	0.90	1.92	2.22	12	1.10	1.60	1.85
	30	8	0.88	2.65	3.06	10	1.00	1.93	2.22	12	1.26	1.68	1.95
	35	9	0.94	2.50	2.89	11	1.10	1.92	2.22	13	1.46	1.80	2.08
	40	9	1.00	2.38	2.74	11	1.18	1.88	2.17	13	1.68	1.91	2.21
240° ◔	20	7	0.96	2.83	3.27	9	1.07	1.90	2.20	11	1.33	1.59	1.84
	25	8	1.07	2.74	3.16	10	1.20	1.92	2.22	12	1.47	1.60	1.85
	30	8	1.17	2.65	3.06	10	1.33	1.93	2.22	12	1.68	1.68	1.95
	35	9	1.25	2.50	2.89	11	1.47	1.92	2.22	13	1.95	1.80	2.08
	40	9	1.33	2.38	2.74	11	1.57	1.88	2.17	13	2.24	1.91	2.21
270° ◓	20	7	1.08	2.83	3.27	9	1.20	1.90	2.20	11	1.50	1.59	1.84
	25	8	1.20	2.74	3.16	10	1.35	1.92	2.22	12	1.65	1.60	1.85
	30	8	1.32	2.65	3.06	10	1.50	1.93	2.22	12	1.89	1.68	1.95
	35	9	1.41	2.50	2.89	11	1.65	1.92	2.22	13	2.19	1.80	2.08
	40	9	1.50	2.38	2.74	11	1.77	1.88	2.17	13	2.52	1.91	2.21
360° ●	20	7	1.44	2.83	3.27	9	1.60	1.90	2.20	11	2.00	1.59	1.84
	25	8	1.60	2.74	3.16	10	1.80	1.92	2.22	12	2.20	1.60	1.85
	30	8	1.76	2.65	3.06	10	2.00	1.93	2.22	12	2.52	1.68	1.95
	35	9	1.88	2.50	2.89	11	2.20	1.92	2.22	13	2.92	1.80	2.08
	40	9	2.00	2.38	2.74	11	2.36	1.88	2.17	13	3.36	1.91	2.21

Bold = Recommended pressure

PS ULTRA STANDARD NOZZLES PERFORMANCE DATA

Arc	Pressure PSI	15A ● Black 15' radius Adjustable from 0° to 360° Trajectory: 28°			17A ● Gray 17' radius Adjustable from 0° to 360° Trajectory: 28°				
		Radius ft.	Flow GPM	Precip in/hr ■ ▲	Radius ft.	Flow GPM	Precip in/hr ■ ▲		
45° 	20	14	0.39	1.51	1.75	16	0.49	1.46	1.68
	25	15	0.43	1.57	1.82	17	0.57	1.60	1.85
	30	15	0.47	1.59	1.84	17	0.58	1.53	1.77
	35	16	0.52	1.55	1.79	18	0.63	1.49	1.72
	40	17	0.57	1.60	1.85	19	0.69	1.55	1.79
90° 	20	14	0.77	1.51	1.75	16	0.97	1.46	1.68
	25	15	0.86	1.57	1.82	17	1.13	1.60	1.85
	30	15	0.93	1.59	1.84	17	1.15	1.53	1.77
	35	16	1.03	1.55	1.79	18	1.25	1.49	1.72
	40	17	1.13	1.60	1.85	19	1.38	1.55	1.79
120° 	20	14	1.03	1.51	1.75	16	1.29	1.46	1.68
	25	15	1.15	1.57	1.82	17	1.51	1.51	1.74
	30	15	1.24	1.59	1.84	17	1.53	1.53	1.77
	35	16	1.37	1.55	1.79	18	1.67	1.49	1.72
	40	17	1.51	1.60	1.85	19	1.84	1.47	1.70
180° 	20	14	1.54	1.51	1.75	16	1.94	1.46	1.68
	25	15	1.72	1.57	1.82	17	2.26	1.51	1.74
	30	15	1.86	1.59	1.84	17	2.30	1.53	1.77
	35	16	2.06	1.55	1.79	18	2.50	1.49	1.72
	40	17	2.26	1.60	1.85	19	2.76	1.47	1.70
240° 	20	14	2.05	1.51	1.75	16	2.59	1.46	1.68
	25	15	2.29	1.57	1.82	17	3.01	1.51	1.74
	30	15	2.48	1.59	1.84	17	3.07	1.53	1.77
	35	16	2.75	1.55	1.79	18	3.33	1.49	1.72
	40	17	3.01	1.60	1.85	19	3.68	1.47	1.70
270° 	20	14	2.31	1.51	1.75	16	2.91	1.46	1.68
	25	15	2.58	1.57	1.82	17	3.39	1.51	1.74
	30	15	2.79	1.59	1.84	17	3.45	1.53	1.77
	35	16	3.09	1.55	1.79	18	3.75	1.49	1.72
	40	17	3.39	1.60	1.85	19	4.14	1.47	1.70
360° 	20	14	3.08	1.51	1.75	16	3.88	1.46	1.68
	25	15	3.44	1.57	1.82	17	4.52	1.51	1.74
	30	15	3.72	1.59	1.84	17	4.60	1.53	1.77
	35	16	4.12	1.55	1.79	18	5.00	1.49	1.72
	40	17	4.52	1.60	1.85	19	5.52	1.47	1.70

Bold = Recommended pressure

STRIP PATTERN NOZZLE PERFORMANCE DATA

Model	Pressure PSI	Width x Length ft.	Flow GPM
SS-530 	20	4 x 28	1.10
	25	5 x 30	1.20
	30	5 x 30	1.30
	35	5 x 30	1.40
	40	5 x 30	1.50

Bold = Recommended pressure

PRO-SPRAY®

Meet the strongest, most versatile spray sprinkler body in the industry.

KEY BENEFITS

- Industry's strongest spray body for years of reliable performance
- Co-molded wiper seal made from chemical- and chlorine-resistant materials
- Innovative seal design prevents cap-to-body leaks, even with a loose cap
- Heavy-duty spring for consistent riser retraction
- Check valve option eliminates low-head drainage

ADDITIONAL FEATURES

- Directional flush plug design for cleaner installation
- Interchangeable components for easier servicing, retrofits, and upgrades
- Compatible with all female-threaded nozzles

OPERATING SPECIFICATIONS

- Operational pressure range: 15 to 100 PSI
- Warranty period: 5 years

FACTORY-INSTALLED OPTIONS

- Check valve available for 4", 6", and 12" models (up to 10' of elevation)
- Reclaimed water ID cap

USER-INSTALLED OPTIONS

- Drain check valve (up to 10' of elevation; P/N 437400SP)
- Reclaimed water ID cap (P/N 458520SP)
- Snap-on reclaimed cover (P/N PROS-RC-CAP-SP)
- Shutoff cap (P/N 213600SP)
- Shutoff nozzle (P/N 916400SP)



Pro-Spray Reclaimed

Pro-Spray models include optional factory-installed purple reclaimed caps

PRO-SPRAY - SPECIFICATION BUILDER: ORDER 1 + 2

1 Models	2 Options
PROS-00 = Shrub adapter	(blank) = No option
PROS-02 = 2" pop-up	CV = Factory-installed drain check valve (Pop-up models only)
PROS-03 = 3" pop-up	R = Factory-installed reclaimed body cap (Shrub molded in purple)
PROS-04 = 4" pop-up	
PROS-06 = 6" pop-up (no side inlet)	
PROS-12 = 12" pop-up (no side inlet)	

PRO-SPRAY (SIDE INLET) MODELS

Model

PROS-06-SI = 6" pop-up with side inlet

PROS-12-SI = 12" pop-up with side inlet

Examples:

PROS-04 = 4" pop-up

PROS-06-CV = 6" pop-up, drain check valve

PROS-12-CV-R = 12" pop-up, drain check valve, reclaimed body cap



PROS-00

Retracted height: 1½"
Inlet size: ½"



PROS-02

Retracted height: 4"
Pop-up height: 2"
Exposed diameter: 2¼"
Inlet size: ½"



PROS-03

Retracted height: 5"
Pop-up height: 3"
Exposed diameter: 2¼"
Inlet size: ½"



PROS-04

Retracted height: 5⅞"
Pop-up height: 4"
Exposed diameter: 2¼"
Inlet size: ½"



[A] PROS-06-SI

[B] PROS-06

Retracted height: 8¾"
Pop-up height: 6"
Exposed diameter: 2¼"
Inlet size: ½"



[A] PROS-12-SI

[B] PROS-12

Retracted height: 16⅞"
Pop-up height: 12"
Exposed diameter: 2¼"
Inlet size: ½"

PRO-SPRAY® PRS30

To maintain consistent performance and reduce water waste, the Pro-Spray PRS30 Sprinkler Body is pressure-regulated to an optimal pressure of 30 PSI.

KEY BENEFITS

- Industry's strongest spray sprinkler body for years of reliable performance
- Pressure-regulated to 30 PSI for optimal nozzle performance
- Brown cap for easy field identification
- Co-molded wiper seal made from chemical- and chlorine-resistant materials
- Innovative seal design prevents cap-to-body leaks, even with a loose cap
- FloGuard™ Technology option eliminates water waste in the event of a missing nozzle

ADDITIONAL FEATURES

- Directional flush plug design for cleaner installation
- Interchangeable components for easier servicing, retrofits, and upgrades
- Heavy-duty spring for consistent riser retraction
- Check valve option eliminates low-head drainage
- Compatible with all female-threaded nozzles

OPERATING SPECIFICATIONS

- Operational pressure range: 15 to 100 PSI
- Warranty period: 5 years

FACTORY-INSTALLED OPTIONS

- Check valve available for 4", 6", and 12" models (up to 14' of elevation)
- Reclaimed water identification
- FloGuard Technology available for check valve models

USER-INSTALLED OPTIONS

- Check valve: P/N 437400SP
 - Up to 10' of elevation for 3" model
 - Up to 14' of elevation for 4", 6", and 12" models
- Reclaimed water ID cap: P/N 458560SP
- Snap-on reclaimed cover: P/N PROS-RC-CAP-SP
- Shutoff cap: P/N 213600SP
- Shutoff nozzle: P/N 916400SP



PRS30 Reclaimed

Optional factory-installed purple reclaimed water caps



FloGuard Technology

Eliminate water waste in the event of a missing nozzle



EPA WaterSense® Certified

Recognized as a responsible water-saving tool by the U.S. Environmental Protection Agency



PROS-00-PRS30

Retracted height: 4½"
Inlet size: ½"



PROS-03-PRS30

Retracted height: 5"
Pop-up height: 3"
Exposed diameter: 2¼"
Inlet size: ½"



PROS-04-PRS30

Retracted height: 5⅞"
Pop-up height: 4"
Exposed diameter: 2¼"
Inlet size: ½"



[A] PROS-06-SI-PRS30

[B] PROS-06-PRS30

Retracted height: 8¾"
Pop-up height: 6"
Exposed diameter: 2¼"
Inlet size: ½"



[A] PROS-12-SI-PRS30

[B] PROS-12-PRS30

Retracted height: 16⅞"
Pop-up height: 12"
Exposed diameter: 2¼"
Inlet size: ½"

PRO-SPRAY PRS30 – SPECIFICATION BUILDER: ORDER 1 + 2 + 3

1 Model	2 Feature Options	3 Specialty Options
<p>PROS-00-PRS30 = 30 PSI regulated shrub adapter</p> <p>PROS-03-PRS30 = 30 PSI regulated 3" pop-up</p> <p>PROS-04-PRS30 = 30 PSI regulated 4" pop-up</p> <p>PROS-06-PRS30 = 30 PSI regulated 6" pop-up</p> <p>PROS-12-PRS30 = 30 PSI regulated 12" pop-up</p>	<p>(blank) = No option</p> <p>CV = Factory-installed drain check valve (4", 6", and 12" models only)</p>	<p>(blank) = No option</p> <p>R = Factory-installed reclaimed body cap</p> <p>F = FloGuard Technology (4", 6", and 12" models only)</p> <p>F-R = FloGuard Technology with reclaimed body cap (4", 6", and 12" models only)</p>

PRO-SPRAY PRS30 (SIDE INLET) MODELS

Model

PROS-06-SI-PRS30 = 30 PSI regulated 6" pop-up with side inlet

PROS-12-SI-PRS30 = 30 PSI regulated 12" pop-up with side inlet

Examples:

PROS-06-SI-PRS30 = 6" pop-up with side inlet regulated at 30 PSI

PROS-06-PRS30-CV = 6" pop-up regulated at 30 PSI, drain check valve

PROS-12-PRS30-CV-F-R = 12" pop-up regulated at 30 PSI, drain check valve, and FloGuard Technology with reclaimed body cap

Compatible with:



Pro Adjustable Nozzles

Page 66

Pro Fixed Nozzles

Page 69

Pro High-Efficiency Nozzles

Page 64

PRO-SPRAY® PRS40

To optimize MP Rotator® Nozzle performance, the Pro-Spray PRS40 Sprinkler Body is pressure-regulated to 40 PSI.

KEY BENEFITS

- Industry's strongest spray sprinkler body for years of reliable performance
- Pressure-regulated to 40 PSI for the MP Rotator Nozzle
- Gray cap for easy field identification
- Co-molded wiper seal made from chemical- and chlorine-resistant materials
- Innovative seal design prevents cap-to-body leaks, even with a loose cap
- FloGuard™ Technology option eliminates water waste in the event of a missing nozzle

ADDITIONAL FEATURES

- Directional flush plug design for cleaner installation
- Interchangeable components for easier servicing, retrofits, and upgrades
- Heavy-duty spring for consistent riser retraction
- Check valve option eliminates low-head drainage

OPERATING SPECIFICATIONS

- Operational pressure range: 15 to 100 PSI
- Warranty period: 5 years

FACTORY-INSTALLED OPTIONS

- Check valve available for 4", 6", and 12" models (up to 14' of elevation)
- Reclaimed water identification
- FloGuard Technology available for pop-up models

USER-INSTALLED OPTIONS

- Check valve: P/N 437400SP
 - Up to 10' of elevation for 3" model
 - Up to 14' of elevation for 4", 6", and 12" models
- Reclaimed water ID cap: P/N 458562SP
- Snap-on reclaimed cover: P/N PROS-RC-CAP-SP
- Shutoff cap: P/N 213600SP
- Shutoff nozzle: P/N 916400SP



PRS40 Reclaimed

Optional factory-installed purple reclaimed water caps



FloGuard Technology

Eliminate water waste in the event of a missing nozzle



EPA WaterSense® Approved

Recognized as a responsible water-saving tool by the U.S. Environmental Protection Agency



PROS-00-PRS40
Retracted height: 4½"
Inlet size: ½"



PROS-03-PRS40
Retracted height: 5"
Pop-up height: 3"
Exposed diameter: 2¼"
Inlet size: ½"



PROS-04-PRS40-CV
Retracted height: 5½"
Pop-up height: 4"
Exposed diameter: 2¼"
Inlet size: ½"



PROS-06-PRS40-CV
Retracted height: 8¾"
Pop-up height: 6"
Exposed diameter: 2¼"
Inlet size: ½"



PROS-12-PRS40-CV
Retracted height: 16½"
Pop-up height: 12"
Exposed diameter: 2¼"
Inlet size: ½"

PRO-SPRAY PRS40 – SPECIFICATION BUILDER: ORDER 1 + 2 + 3

1 Model	2 Feature Options	3 Specialty Options
<p>PROS-00-PRS40 = 40 PSI regulated shrub adapter PROS-03-PRS40 = 40 PSI regulated 3" pop-up PROS-04-PRS40 = 40 PSI regulated 4" pop-up PROS-06-PRS40 = 40 PSI regulated 6" pop-up PROS-12-PRS40 = 40 PSI regulated 12" pop-up</p>	<p>(blank) = No option CV = Factory-installed drain check valve (4", 6", and 12" models only)</p>	<p>(blank) = No option R = Factory-installed reclaimed body cap F = FloGuard Technology (4", 6", and 12" models only) F-R = FloGuard Technology with reclaimed body cap (4", 6", and 12" models only)</p>

PRO-SPRAY PRS40 (SIDE INLET) MODELS

Model

PROS-06-SI-PRS40 = 40 PSI regulated 6" pop-up with side inlet

PROS-12-SI-PRS40 = 40 PSI regulated 12" pop-up with side inlet

Examples:

PROS-06-SI-PRS40 = 6" pop-up with side inlet regulated at 40 PSI
PROS-06-PRS40-CV = 6" pop-up regulated at 40 PSI, drain check valve
PROS-12-PRS40-CV-F-R = 12" pop-up regulated at 40 PSI, drain check valve, and FloGuard Technology with reclaimed body cap

Compatible with:



**MP Rotator
Nozzles
Page 42**

SPRAY ACCESSORIES

Spray accessories provide additional flexibility for installation and maintenance of spray systems.

SJ SWING JOINTS

Features

- Unique swivel ells on both ends for easy installation in any configuration
- Airtight connection points for long-term reliability

Models

- SJ-506: 1/2" threaded x 6" length standard
- SJ-7506: 1/2" x 3/4" threaded x 6" length
- SJ-706: 3/4" threaded x 6" length
- SJ-512: 1/2" threaded x 12" length
- SJ-7512: 1/2" x 3/4" threaded x 12" length
- SJ-712: 3/4" threaded x 12" length

Operating Specifications

- Pressure-rated to 150 PSI
- Warranty period: 2 years

HUNTER SPIRAL BARB ELBOWS

Features

- Improved bigger, stronger design
- Compatible with FlexSG Tubing and other brands for a customized swing joint
- Spiral-to-barb design for easier installation
- Acetal material for sharp barbs

Models

- HSBE-050: 1/2" male thread x spiral barb elbow
- HSBE-075: 3/4" male thread x spiral barb elbow

Operating Specifications

- Operating pressure: Up to 80 PSI
- Warranty period: 2 years

FLEXSG TUBING

Features

- Engineered to resist kinking
- Textured for easy grip
- Linear low-density polyethylene material
- Meets ASTM D2104, D2239, D2737

Models

- FLEXSG: 100' roll
- FLEXSG-18: 18" pre-cut lengths

Operating Specifications

- Operating pressure: up to 80 PSI
- Warranty period: 2 years

PRO-SPRAY SHUTOFF CAP

Features

- Caps off the Pro-Spray Sprinkler Body for maintenance or drip conversions
- Maintains a clean look to the landscape

Models

- P/N 213600SP

SHUTOFF NOZZLE

Features

- Easy shutoff for spray systems
- Allows heads to pop-up for easy visibility
- Use with Pro-Spray and PS Ultra models

Models

- P/N 916400SP



SJ Swing Joints

6" and 12" links



Spiral Barb Elbows

P/N HSBE-050, P/N HSBE-075



FlexSG Tubing

100' and 18" pre-cut lengths
Inside diameter: 0.49"



Pro-Spray Shutoff Cap

P/N 213600SP



Shutoff Nozzle

P/N 916400SP

NOZZLES



PRO HIGH-EFFICIENCY NOZZLES

Pro High-Efficiency Nozzles provide increased efficiency for spray systems through high uniformity from the spray pattern at a matched precipitation rate across the line.

KEY BENEFITS

- High-efficiency performance from a high-uniformity spray pattern
- Matched precipitation of 1.6 in/hr from 8' to 17' across the 0° to 360° adjustable arc range
- Smooth spray pattern with well-defined edges for targeted landscape irrigation
- Color-coded with natural hues to blend with the landscape and provide easy field identification

ADDITIONAL FEATURES

- Simple arc adjustment using the easy-grip nozzle top
- Thick nozzle top offers long-lasting durability against equipment damage
- Fast installation with clear identification of spray pattern edges

OPERATING SPECIFICATIONS

- Recommended operating pressure: 30 PSI
- Pair with Pro-Spray® PRS30 Sprinkler Bodies for pressure regulation to 30 PSI
- Warranty period: 2 years



8A-HE Nozzle
Radius: 8'



10A-HE Nozzle
Radius: 10'



12A-HE Nozzle
Radius: 12'



15A-HE Nozzle
Radius: 15'



17A-HE Nozzle
Radius: 17'

PRO HIGH-EFFICIENCY NOZZLES PERFORMANCE DATA



8A-HE

● Olive Green

8' radius
Adjustable from 0° to 360°
Trajectory: 20°

10A-HE

● Dark Blue

10' radius
Adjustable from 0° to 360°
Trajectory: 25°

Arc	Pressure PSI	Radius ft	Flow			Precip in/hr				
			GPM	■	▲	ft	GPM	■	▲	
90° 	20	7	0.23	1.81	2.09	8	0.36	1.71	1.98	
	25	7	0.27	2.12	2.45		9	0.41	1.95	2.25
	30	8	0.28	1.68	1.95		10	0.44	1.69	1.96
	35	8	0.32	1.93	2.22		10	0.48	1.85	2.13
180° 	20	7	0.44	1.71	1.97	8	0.70	1.66	1.92	
	25	7	0.49	1.93	2.22		9	0.78	1.85	2.13
	30	8	0.55	1.65	1.90		10	0.86	1.65	1.90
	35	8	0.63	1.88	2.17		10	0.93	1.79	2.07
270° 	20	7	0.65	1.71	1.97	8	1.00	1.93	2.22	
	25	7	0.74	1.93	2.22		9	1.17	1.85	2.13
	30	8	0.82	1.65	1.90		10	1.28	1.65	1.90
	35	8	0.94	1.88	2.17		10	1.40	1.79	2.07
360° 	20	7	0.87	1.71	1.97	8	1.50	1.93	2.22	
	25	7	0.98	1.93	2.22		9	1.40	1.66	1.92
	30	8	1.10	1.65	1.90		9	1.55	1.85	2.13
	35	8	1.25	1.88	2.17		10	1.86	1.79	2.07
	40	9	1.36	1.62	1.87	10	2.00	1.93	2.22	

PRO HIGH-EFFICIENCY NOZZLES PERFORMANCE DATA



12A-HE
● Brown
12' radius
Adjustable from 0° to 360°
Trajectory: 25°

15A-HE
● Black
15' radius
Adjustable from 0° to 360°
Trajectory: 25°

17A-HE
● Gray
17' radius
Adjustable from 0° to 360°
Trajectory: 25°

Arc	Pressure PSI	Radius ft	Flow			Precip in/hr			Radius ft	Flow			Precip in/hr			Radius ft	Flow			Precip in/hr		
			GPM	■	▲	GPM	■	▲		GPM	■	▲	GPM	■	▲		GPM	■	▲			
90° 	20	11	0.53	1.69	1.95	14	0.78	1.53	1.77	16	0.95	1.43	1.66	16	1.07	1.60	1.85					
	25	11	0.59	1.88	2.17	14	0.88	1.73	2.00	16	1.07	1.60	1.85	16	1.07	1.60	1.85					
	30	12	0.63	1.68	1.95	15	0.96	1.64	1.90	17	1.24	1.65	1.91	17	1.24	1.65	1.91					
	35	12	0.70	1.87	2.16	15	1.07	1.83	2.11	17	1.29	1.72	1.99	17	1.29	1.72	1.99					
	40	12	0.75	2.01	2.32	15	1.13	1.93	2.23	17	1.39	1.85	2.13	17	1.39	1.85	2.13					
180° 	20	11	1.03	1.63	1.88	14	1.53	1.50	1.73	16	1.77	1.33	1.53	16	2.04	1.53	1.77					
	25	11	1.12	1.78	2.06	14	1.69	1.66	1.91	16	2.04	1.53	1.77	16	2.04	1.53	1.77					
	30	12	1.22	1.63	1.88	15	1.87	1.60	1.85	17	2.36	1.57	1.82	17	2.36	1.57	1.82					
	35	12	1.33	1.78	2.05	15	2.05	1.75	2.03	17	2.47	1.64	1.90	17	2.47	1.64	1.90					
	40	12	1.46	1.95	2.25	15	2.22	1.90	2.19	17	2.65	1.77	2.04	17	2.65	1.77	2.04					
270° 	20	11	1.54	1.63	1.88	14	2.29	1.50	1.73	16	2.65	1.33	1.53	16	3.05	1.53	1.77					
	25	11	1.68	1.78	2.06	14	2.53	1.66	1.91	16	3.05	1.53	1.77	16	3.05	1.53	1.77					
	30	12	1.83	1.63	1.88	15	2.81	1.60	1.85	17	3.54	1.57	1.82	17	3.54	1.57	1.82					
	35	12	2.00	1.78	2.05	15	3.08	1.75	2.03	17	3.70	1.64	1.90	17	3.70	1.64	1.90					
	40	12	2.19	1.95	2.25	15	3.33	1.90	2.19	17	3.98	1.77	2.04	17	3.98	1.77	2.04					
360° 	20	11	2.05	1.63	1.88	14	3.05	1.50	1.73	16	3.53	1.33	1.53	16	4.07	1.53	1.77					
	25	11	2.24	1.78	2.06	14	3.37	1.66	1.91	16	4.07	1.53	1.77	16	4.07	1.53	1.77					
	30	12	2.44	1.63	1.88	15	3.74	1.60	1.85	17	4.72	1.57	1.82	17	4.72	1.57	1.82					
	35	12	2.66	1.78	2.05	15	4.10	1.75	2.03	17	4.93	1.64	1.90	17	4.93	1.64	1.90					
	40	12	2.92	1.95	2.25	15	4.43	1.90	2.19	17	5.30	1.77	2.04	17	5.30	1.77	2.04					

Bold = Recommended pressure

Note: The Pro-Spray PRS30 Sprinkler Body's built-in pressure regulator controls output to a maximum of 30 PSI. Adjusting the radius reduction screw may be required to achieve catalog radius and flow.

Pro High-Efficiency Nozzles



PRO ADJUSTABLE NOZZLES

Choose Pro Adjustable Nozzles for optimal landscape coverage in any setting.

KEY BENEFITS

- Adjustable from 0° to 360° for maximum design flexibility
- Easy-grip top for simple adjustment
- Strong edges for a defined pattern with better wind resistance
- Large water droplets minimize misting with better uniformity

ADDITIONAL FEATURES

- Matched precipitation rate on each nozzle from 8A to 17A
- Even distribution results in better coverage
- Color-coded for easy field identification

OPERATING SPECIFICATIONS

- Recommended operating pressure: 30 PSI
- Pair with Pro-Spray PRS30 pop-up for pressure regulation to 30 PSI
- Warranty period: 2 years



4A
Radius: 4'



6A
Radius: 6'



8A
Radius: 8'



10A
Radius: 10'



12A
Radius: 12'



15A
Radius: 15'



17A
Radius: 17'

Pro Adjustable Nozzle



PRO ADJUSTABLE NOZZLES PERFORMANCE DATA



4A

● Lt. Green

4' radius
Adjustable from
0° to 360°
Trajectory: 0°

6A

● Lt. Blue

6' radius
Adjustable from
0° to 360°
Trajectory: 0°

8A

● Brown

8' radius
Adjustable from
0° to 360°
Trajectory: 15°

10A

● Red

10' radius
Adjustable from
0° to 360°
Trajectory: 15°

Arc	Pressure PSI	4A				6A				8A				10A			
		Radius ft	Flow GPM	Precip in/hr ■ ▲		Radius ft	Flow GPM	Precip in/hr ■ ▲		Radius ft	Flow GPM	Precip in/hr ■ ▲		Radius ft.	Flow GPM	Precip in/hr ■ ▲	
45° ▶	20	3	0.10	7.29	8.42	5	0.15	4.19	4.84	7	0.18	2.83	3.27	9	0.20	1.90	2.20
	25	3	0.11	7.12	8.22	5	0.17	4.36	5.03	8	0.20	2.74	3.16	10	0.23	1.92	2.22
	30	4	0.13	6.26	7.22	6	0.18	3.85	4.45	8	0.22	2.65	3.06	10	0.25	1.93	2.22
	35	4	0.14	6.11	7.06	6	0.18	3.55	4.10	9	0.24	2.50	2.89	11	0.28	1.92	2.22
	40	4	0.16	6.36	7.35	6	0.19	3.57	4.12	9	0.25	2.38	2.74	11	0.30	1.88	2.17
90° ◑	20	3	0.19	6.93	8.00	5	0.30	4.19	4.84	7	0.36	2.83	3.27	9	0.40	1.90	2.20
	25	3	0.20	6.47	7.47	5	0.34	4.49	5.18	8	0.40	2.74	3.16	10	0.45	1.92	2.22
	30	4	0.22	5.29	6.11	6	0.37	3.96	4.57	8	0.44	2.65	3.06	10	0.50	1.93	2.22
	35	4	0.24	5.24	6.05	6	0.38	3.75	4.32	9	0.47	2.50	2.89	11	0.55	1.92	2.22
	40	4	0.25	4.97	5.74	6	0.40	3.76	4.34	9	0.50	2.38	2.74	11	0.59	1.88	2.17
120° ◐	20	3	0.28	7.65	8.84	5	0.37	3.88	4.48	7	0.48	2.83	3.27	9	0.53	1.90	2.20
	25	3	0.30	7.28	8.40	5	0.38	3.76	4.35	8	0.53	2.74	3.16	10	0.60	1.92	2.22
	30	4	0.34	6.14	7.09	6	0.44	3.53	4.08	8	0.59	2.65	3.06	10	0.67	1.93	2.22
	35	4	0.36	5.81	6.71	6	0.46	3.40	3.93	9	0.63	2.50	2.89	11	0.73	1.92	2.22
	40	4	0.37	5.52	6.37	6	0.48	3.38	3.91	9	0.67	2.38	2.74	11	0.79	1.88	2.17
180° ◐	20	3	0.34	6.20	7.16	5	0.50	3.49	4.03	7	0.72	2.83	3.27	9	0.80	1.90	2.20
	25	3	0.38	6.15	7.10	5	0.54	3.56	4.12	8	0.80	2.74	3.16	10	0.90	1.92	2.22
	30	4	0.45	5.41	6.25	6	0.60	3.21	3.70	8	0.88	2.65	3.06	10	1.00	1.93	2.22
	35	4	0.46	5.02	5.80	6	0.64	3.15	3.64	9	0.94	2.50	2.89	11	1.10	1.92	2.22
	40	4	0.48	4.77	5.51	6	0.68	3.20	3.69	9	1.00	2.38	2.74	11	1.18	1.88	2.17
240° ◐	20	3	0.58	7.93	9.15	5	0.73	3.82	4.42	7	0.96	2.83	3.27	9	1.07	1.90	2.20
	25	3	0.62	7.52	8.68	5	0.78	3.86	4.46	8	1.07	2.74	3.16	10	1.20	1.92	2.22
	30	4	0.68	6.14	7.09	6	0.88	3.53	4.08	8	1.17	2.65	3.06	10	1.33	1.93	2.22
	35	4	0.74	6.06	6.99	6	0.92	3.40	3.93	9	1.25	2.50	2.89	11	1.47	1.92	2.22
	40	4	0.80	5.97	6.89	6	1.02	3.60	4.15	9	1.33	2.38	2.74	11	1.57	1.88	2.17
270° ◐	20	3	0.62	7.53	8.70	5	0.88	4.10	4.73	7	1.08	2.83	3.27	9	1.20	1.90	2.20
	25	3	0.66	7.12	8.22	5	0.98	4.31	4.98	8	1.20	2.74	3.16	10	1.35	1.92	2.22
	30	4	0.73	5.86	6.76	6	1.10	3.92	4.53	8	1.32	2.65	3.06	10	1.50	1.93	2.22
	35	4	0.78	5.67	6.55	6	1.15	3.78	4.36	9	1.41	2.50	2.89	11	1.65	1.92	2.22
	40	4	0.84	5.57	6.43	6	1.20	3.76	4.34	9	1.50	2.38	2.74	11	1.77	1.88	2.17
360° ●	20	3	0.66	6.01	6.94	5	1.05	3.67	4.23	7	1.44	2.83	3.27	9	1.60	1.90	2.20
	25	3	0.72	5.82	6.72	5	1.10	3.63	4.19	8	1.60	2.74	3.16	10	1.80	1.92	2.22
	30	4	0.80	4.81	5.56	6	1.26	3.37	3.89	8	1.76	2.65	3.06	10	2.00	1.93	2.22
	35	4	0.86	4.69	5.42	6	1.30	3.20	3.70	9	1.88	2.50	2.89	11	2.20	1.92	2.22
	40	4	0.90	4.47	5.17	6	1.40	3.29	3.80	9	2.00	2.38	2.74	11	2.36	1.88	2.17

Bold = Recommended pressure

Note: The Pro-Spray PRS30's built-in pressure regulator controls output to a maximum of 30 PSI. Adjusting the radius reduction screw may be required to achieve catalog radius and flow.

PRO ADJUSTABLE NOZZLES PERFORMANCE DATA



12A 12' radius
Adjustable from
0° to 360°
Trajectory: 28°
● Green

15A 15' radius
Adjustable from
0° to 360°
Trajectory: 28°
● Black

17A 17' radius
Adjustable from
0° to 360°
Trajectory: 28°
● Gray

Arc	Pressure PSI	Radius ft	Flow			Precip in/hr			Radius ft	Flow GPM	Precip in/hr		
			GPM	■	▲	■	▲	■			▲		
45° ▶	20	11	0.25	1.59	1.84	14	0.39	1.51	1.75	16	0.49	1.46	1.68
	25	12	0.28	1.60	1.85	15	0.43	1.57	1.82	17	0.57	1.60	1.85
	30	12	0.32	1.68	1.95	15	0.47	1.59	1.84	17	0.58	1.53	1.77
	35	13	0.37	1.80	2.08	16	0.52	1.55	1.79	18	0.63	1.49	1.72
	40	13	0.42	1.91	2.21	17	0.57	1.60	1.85	19	0.69	1.55	1.79
90° ◐	20	11	0.50	1.59	1.84	14	0.77	1.51	1.75	16	0.97	1.46	1.68
	25	12	0.55	1.60	1.85	15	0.86	1.57	1.82	17	1.13	1.60	1.85
	30	12	0.63	1.68	1.95	15	0.93	1.59	1.84	17	1.15	1.53	1.77
	35	13	0.73	1.80	2.08	16	1.03	1.55	1.79	18	1.25	1.49	1.72
	40	13	0.84	1.91	2.21	17	1.13	1.60	1.85	19	1.38	1.55	1.79
120° ◑	20	11	0.67	1.59	1.84	14	1.03	1.51	1.75	16	1.29	1.46	1.68
	25	12	0.73	1.60	1.85	15	1.15	1.57	1.82	17	1.51	1.51	1.74
	30	12	0.84	1.68	1.95	15	1.24	1.59	1.84	17	1.53	1.53	1.77
	35	13	0.97	1.80	2.08	16	1.37	1.55	1.79	18	1.67	1.49	1.72
	40	13	1.12	1.91	2.21	17	1.51	1.60	1.85	19	1.84	1.47	1.70
180° ◒	20	11	1.00	1.59	1.84	14	1.54	1.51	1.75	16	1.94	1.46	1.68
	25	12	1.10	1.60	1.85	15	1.72	1.57	1.82	17	2.26	1.51	1.74
	30	12	1.26	1.68	1.95	15	1.86	1.59	1.84	17	2.30	1.53	1.77
	35	13	1.46	1.80	2.08	16	2.06	1.55	1.79	18	2.50	1.49	1.72
	40	13	1.68	1.91	2.21	17	2.26	1.60	1.85	19	2.76	1.47	1.70
240° ◓	20	11	1.33	1.59	1.84	14	2.05	1.51	1.75	16	2.59	1.46	1.68
	25	12	1.47	1.60	1.85	15	2.29	1.57	1.82	17	3.01	1.51	1.74
	30	12	1.68	1.68	1.95	15	2.48	1.59	1.84	17	3.07	1.53	1.77
	35	13	1.95	1.80	2.08	16	2.75	1.55	1.79	18	3.33	1.49	1.72
	40	13	2.24	1.91	2.21	17	3.01	1.60	1.85	19	3.68	1.47	1.70
270° ◔	20	11	1.50	1.59	1.84	14	2.31	1.51	1.75	16	2.91	1.46	1.68
	25	12	1.65	1.60	1.85	15	2.58	1.57	1.82	17	3.39	1.51	1.74
	30	12	1.89	1.68	1.95	15	2.79	1.59	1.84	17	3.45	1.53	1.77
	35	13	2.19	1.80	2.08	16	3.09	1.55	1.79	18	3.75	1.49	1.72
	40	13	2.52	1.91	2.21	17	3.39	1.60	1.85	19	4.14	1.47	1.70
360° ◕	20	11	2.00	1.59	1.84	14	3.08	1.51	1.75	16	3.88	1.46	1.68
	25	12	2.20	1.60	1.85	15	3.44	1.57	1.82	17	4.52	1.51	1.74
	30	12	2.52	1.68	1.95	15	3.72	1.59	1.84	17	4.60	1.53	1.77
	35	13	2.92	1.80	2.08	16	4.12	1.55	1.79	18	5.00	1.49	1.72
	40	13	3.36	1.91	2.21	17	4.52	1.60	1.85	19	5.52	1.47	1.70

Bold = Recommended pressure

Note: The Pro-Spray PRS30's built-in pressure regulator controls output to a maximum of 30 PSI. Adjusting the radius reduction screw may be required to achieve catalog radius and flow.

PRO FIXED NOZZLES

Pro Fixed Nozzles are designed for high accuracy within a variety of landscape shapes and sizes.

KEY BENEFITS

- Clean edges for a defined pattern with better wind resistance
- Large water droplets minimize misting with better uniformity
- Sturdy construction ensures reliable performance
- Color-coded for easy field identification

OPERATING SPECIFICATIONS

- Recommended operating pressure: 30 PSI
- Pair with Pro-Spray® PRS30 Sprinkler Bodies for pressure regulation to 30 PSI
- Warranty period: 2 years

PRO FIXED NOZZLES						
ARC	5	8	10	12	15	17
Q						
T	Use 4A/6A Nozzle					Use 17A Nozzle
H						
F						Use 17A Nozzle
	5'	8'	10'	12'	15'	17'

PRO FIXED NOZZLES PERFORMANCE DATA



5 5' radius
Fixed: ¼, ½, Full
● Blue Trajectory: 0°

8 8' radius
Fixed: ¼, ½, Full
● Brown Trajectory: 15°

10 10' radius
Fixed: ¼, ½, Full
● Red Trajectory: 15°

Arc	Position	Pressure PSI	5'				8'				10'			
			Radius ft	Flow GPM	Precip in/hr ■ ▲		Radius ft	Flow GPM	Precip in/hr ■ ▲		Radius ft	Flow GPM	Precip in/hr ■ ▲	
90° Q	Q	20	4	0.09	2.25	2.60	7	0.20	1.54	1.78	9	0.34	1.63	1.88
		25	4	0.11	2.54	2.94	8	0.22	1.33	1.53	10	0.39	1.48	1.71
		30	5	0.12	1.80	2.08	8	0.24	1.46	1.69	10	0.42	1.63	1.89
		35	6	0.13	1.36	1.57	9	0.26	1.25	1.45	11	0.46	1.47	1.69
		40	6	0.14	1.46	1.69	9	0.28	1.34	1.55	11	0.49	1.57	1.82
120° T	T	20	Use Hunter 4A or 6A Nozzle				7	0.26	1.54	1.78	9	0.46	1.63	1.88
		25					8	0.29	1.33	1.53	10	0.51	1.48	1.71
		30					8	0.32	1.46	1.69	10	0.57	1.63	1.89
		35					9	0.35	1.25	1.45	11	0.61	1.47	1.69
		40					9	0.38	1.34	1.55	11	0.66	1.57	1.82
180° H	H	20	4	0.19	2.25	2.60	7	0.38	1.49	1.72	9	0.70	1.67	1.92
		25	4	0.21	2.54	2.94	8	0.43	1.28	1.48	10	0.79	1.53	1.76
		30	5	0.23	1.80	2.08	8	0.47	1.41	1.63	10	0.88	1.69	1.95
		35	6	0.25	1.36	1.57	9	0.51	1.21	1.39	11	0.95	1.52	1.75
		40	6	0.27	1.46	1.69	9	0.54	1.29	1.49	11	1.03	1.63	1.89
360° F	F	20	4	0.37	2.25	2.60	7	0.78	1.54	1.78	9	1.29	1.53	1.77
		25	4	0.42	2.54	2.94	8	0.88	1.33	1.53	10	1.45	1.39	1.61
		30	5	0.47	1.80	2.08	8	0.97	1.46	1.69	10	1.59	1.53	1.76
		35	6	0.51	1.36	1.57	9	1.05	1.25	1.45	11	1.72	1.37	1.58
		40	6	0.55	1.46	1.69	9	1.13	1.34	1.55	11	1.84	1.46	1.69

Bold = Recommended pressure

Pro Fixed Nozzles



PRO FIXED NOZZLES PERFORMANCE DATA



12 12' radius
Fixed: ¼, ½, ¾, Full
Trajectory: 28°
● Green

15 15' radius
Fixed: ¼, ½, ¾, Full
Trajectory: 28°
● Black

17 17' radius
Fixed: ¼, ½
Trajectory: 28°
● Gray

Arc	Position	Pressure	Radius	Flow	Precip in/hr		Radius	Flow	Precip in/hr		Radius	Flow	Precip in/hr	
		PSI			ft	GPM			■	▲			ft	GPM
90° 	Q	20	11	0.54	1.71	1.98	14	0.78	1.53	1.77	16	0.93	1.40	1.61
		25	12	0.61	1.62	1.87	15	0.88	1.51	1.74	17	1.05	1.39	1.61
		30	12	0.67	1.78	2.06	15	0.97	1.67	1.92	17	1.15	1.54	1.77
		35	13	0.72	1.65	1.90	16	1.06	1.59	1.84	18	1.25	1.49	1.72
		40	13	0.78	1.77	2.04	17	1.14	1.52	1.75	19	1.34	1.43	1.65
120° 	T	20	11	0.72	1.71	1.98	14	1.04	1.53	1.77	Use Hunter 17A Nozzle			
		25	12	0.81	1.62	1.87	15	1.17	1.51	1.74				
		30	12	0.89	1.78	2.06	15	1.30	1.67	1.92				
		35	13	0.97	1.65	1.90	16	1.41	1.59	1.84				
		40	13	1.04	1.77	2.04	17	1.52	1.52	1.75				
180° 	H	20	11	1.05	1.67	1.93	14	1.51	1.48	1.71	16	1.91	1.43	1.66
		25	12	1.18	1.58	1.83	15	1.69	1.45	1.67	17	2.15	1.43	1.65
		30	12	1.30	1.74	2.01	15	1.86	1.59	1.84	17	2.37	1.58	1.82
		35	13	1.42	1.61	1.86	16	2.02	1.52	1.75	18	2.57	1.53	1.76
		40	13	1.52	1.73	2.00	17	2.16	1.44	1.66	19	2.76	1.47	1.70
360° 	F	20	11	2.17	1.72	1.99	14	3.04	1.49	1.72	Use Hunter 17A Nozzle			
		25	12	2.45	1.63	1.89	15	3.41	1.46	1.69				
		30	12	2.70	1.80	2.08	15	3.75	1.61	1.85				
		35	13	2.93	1.67	1.93	16	4.07	1.53	1.76				
		40	13	3.15	1.80	2.07	17	4.36	1.45	1.68				

Bold = Recommended pressure

SHORT-RADIUS MICRO SPRAY NOZZLES

These highly accurate nozzles are perfect for small spaces and can support a robust micro spray system with Pro-Spray® pop-ups.

KEY BENEFITS



- Low flow for controlled irrigation of tight spaces
- Meets micro spray requirement of 30 GPH max flow at 30 PSI
- Built to last for a robust overhead solution for small spaces

OPERATING SPECIFICATIONS

- Recommended operating pressure: 30 PSI
- Pair with Pro-Spray PRS30 pop-up for pressure regulation to 30 PSI



SHORT-RADIUS NOZZLES PERFORMANCE DATA

● Lt. Brown

Arc	Pressure PSI	Position	Radius ft.	Flow		*Precip in/hr
				GPM	GPH	
90° 	20	2Q	2	0.09	5.4	2.17
	25		2	0.10	6.0	2.41
	30		2	0.11	6.6	2.65
	35		2	0.13	7.8	3.13
180° 	20	2H	2	0.14	8.4	1.68
	25		2	0.15	9.0	1.80
	30		2	0.20	12.0	2.41
	35		2	0.20	12.0	2.41
40	2	0.21	12.6	2.53		



SHORT-RADIUS NOZZLES PERFORMANCE DATA

● Lt. Green

Arc	Pressure PSI	Position	Radius ft.	Flow		*Precip in/hr
				GPM	GPH	
90° 	20	4Q	4	0.18	10.8	1.08
	25		4	0.20	12.0	1.20
	30		4	0.20	12.0	1.20
	35		4	0.22	13.2	1.32
180° 	20	4H	4	0.33	19.8	0.99
	25		4	0.34	20.4	1.02
	30		4	0.40	24.0	1.20
	35		4	0.40	24.0	1.20
40	4	0.44	26.4	1.32		

SHORT-RADIUS NOZZLES PERFORMANCE DATA

● Lt. Blue

Arc	Pressure PSI	Position	Radius ft.	Flow		*Precip in/hr
				GPM	GPH	
90° 	20	6Q	6	0.22	13.2	0.59
	25		6	0.24	14.4	0.64
	30		6	0.30	18.0	0.80
	35		6	0.30	18.0	0.80
180° 	20	6H	6	0.40	24.0	0.53
	25		6	0.44	26.4	0.59
	30		6	0.50	30.0	0.67
	35		6	0.52	31.2	0.70
40	6	0.54	32.4	0.72		

Bold = Recommended pressure

*Precipitation rate shown without overlap



2Q
Radius: 2'



2H
Radius: 2'



4Q
Radius: 4'



4H
Radius: 4'



6Q
Radius: 6'



6H
Radius: 6'

Short-Radius Micro Spray Nozzle

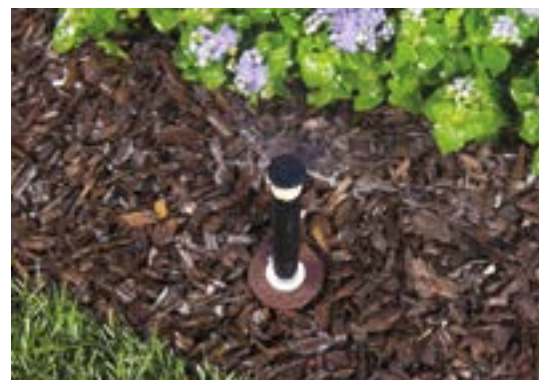

STRIP PATTERN NOZZLES







Irrigate narrow turf and planter areas accurately with fixed arc Strip Pattern Nozzles.

KEY BENEFITS

- Designed for accurate coverage of strip areas
- Available in a variety of models for unique, rectangular spaces
- Built to last in harsh conditions

OPERATING SPECIFICATIONS

- Recommended operating pressure: 30 PSI
- Pair with Pro-Spray® PRS30 pop-up for pressure regulation to 30 PSI
- Warranty period: 2 years

STRIP PATTERN NOZZLE PERFORMANCE DATA			
Arc	Pressure PSI	Width x Length	Flow GPM
LCS-515 	20	4' x 14'	0.55
	25	5' x 15'	0.60
	30	5' x 15'	0.65
	35	5' x 15'	0.70
	40	5' x 15'	0.75
RCS-515 	20	4' x 14'	0.55
	25	5' x 15'	0.60
	30	5' x 15'	0.65
	35	5' x 15'	0.70
SS-530 	20	4' x 28'	1.10
	25	5' x 30'	1.20
	30	5' x 30'	1.30
	35	5' x 30'	1.40
	40	5' x 30'	1.50
SS-918 	20	8' x 17'	1.45
	25	9' x 18'	1.58
	30	9' x 18'	1.72
	35	9' x 18'	1.88
CS-530 	20	4' x 28'	1.10
	25	5' x 30'	1.20
	30	5' x 30'	1.30
	35	5' x 30'	1.40
	40	5' x 30'	1.50
ES-515 	20	4' x 14'	0.55
	25	5' x 15'	0.60
	30	5' x 15'	0.65
	35	5' x 15'	0.70
	40	5' x 15'	0.75

Bold = Recommended pressure

See page 190 for precipitation rate calculation.



Left Corner Strip
Rectangle: 5' x 15'



Right Corner Strip
Rectangle: 5' x 15'



Side Strip
Rectangle: 5' x 30'



Side Strip
Rectangle: 9' x 18'



Center Strip
Rectangle: 5' x 30'



End Strip
Rectangle: 5' x 15'

RCS-515









BUBBLER NOZZLES

Deliver a consistent flow regardless of inlet pressure with pressure-compensating Bubbler Nozzles.

KEY BENEFITS

- Pressure-compensating for constant water flow at any pressure
- Designed for deep watering of planted areas
- Nozzle threaded for use with Pro-Spray® Sprinkler Bodies
- Warranty period: 2 years

MULTI-STREAM BUBBLER PERFORMANCE DATA

Arc	Model	Flow GPM	Radius ft.
	MSBN-25Q	0.25	1.0
	MSBN-50Q	0.50	1.5
	MSBN-50H	0.50	1.0
	MSBN-10H	1.00	1.5
	MSBN-10F	1.00	1.0
	MSBN-20F	2.00	1.5

Multi-Stream Bubbler



Notes:





Typical spacing 2' to 4'. Flows shown for pressures between 15 and 70 PSI.



MSBN Installed on PROS-04

Combining Hunter Bubbler Nozzles with Pro-Spray Sprinkler Bodies provides the watering precision of pressure-compensating bubblers paired with the benefit of retracting the nozzle out of sight.

PCN PERFORMANCE DATA

Model	Flow GPM	Pattern Type
 25	0.25	Trickle
 50	0.50	Trickle
 10	1.00	Umbrella
 20	2.00	Umbrella

PCN



Notes:

Typical spacing 2' to 4'. Flows shown for pressures between 15 and 70 PSI.

5-CST-B BUBBLER NOZZLE PERFORMANCE DATA

Pressure (PSI)	Radius (ft.)	Flow (GPM)
20	5	0.30
25	5	0.32
30	5	0.38
35	5	0.40
40	5	0.42

5-CST-B



MULTI-STREAM BUBBLER NOZZLES



MSBN-25Q
Flow: 0.25 GPM



MSBN-50Q/50H
Flow: 0.50 GPM



MSBN-10H/10F
Flow: 1.0 GPM



MSBN-20F
Flow: 2.0 GPM

PCN BUBBLER NOZZLES



PCN-25
Flow: 0.25 GPM



PCN-50
Flow: 0.50 GPM



PCN-10
Flow: 1.0 GPM



PCN-20
Flow: 2.0 GPM

DUAL-STREAM BUBBLER NOZZLE



5-CST-B

BUBBLERS

Ensure consistent flow regardless of pressure with above-ground, pressure-compensating Bubblers.

KEY BENEFITS

- Pressure-compensating for constant water flow at any pressure
- Designed for deep watering of planted areas
- ½" threaded inlet for easy installation on a ½" riser
- Warranty period: 2 years

PCB PERFORMANCE DATA

	Model	Flow GPM	Pattern Type
	25	0.25	Trickle
	50	0.50	Trickle
	10	1.00	Umbrella
	20	2.00	Umbrella

Notes:

Typical spacing 2' to 4'. Flows shown for pressures between 15 and 70 PSI.

PCB



PRESSURE-COMPENSATING BUBBLERS



PCB



PCB-R

AFB PERFORMANCE DATA

	Model	Flow GPM	Pattern Type
	AFB	< 2.0	Trickle/ Umbrella

AFB



ADJUSTABLE FLOOD BUBBLER



AFB



VALVES

VALVE COMPARISON CHART

QUICK SPECS		1" PGV & JAR-TOP	PGV	ICV	ICV FILTER SENTRY	IBV
SIZE		1"	1½", 2"	1", 1½", 2", 3"	1", 1½", 2", 3"	1", 1½", 2", 3"
FLOW	GPM	0.2 to 40	20 to 150	0.1 to 300	0.1 to 300	0.1 to 300
FEATURES						
CAPTIVE BONNET BOLTS		●	●	●	●	
EPDM DIAPHRAGM AND SEAT				Standard	Standard	Standard
WARRANTY		2 Years	2 Years	5 Years	5 Years	5 Years
ADVANCED FEATURES						
FLOW CONTROL		Optional	●	●	●	●
FILTER SENTRY® MECHANISM				User-Installed	Factory-Installed	Factory-Installed
ACCU SYNC® CAPABLE		●	●	●	●	●
RECLAIMED WATER ID HANDLE		User-Installed	User-Installed	User-Installed	User-Installed	User-Installed
RECLAIMED WATER ID TAG				User-Installed	User-Installed	User-Installed
APPLICATIONS						
RESIDENTIAL		●	●	●		
COMMERCIAL			●	●	●	●
POTABLE WATER		●	●	●	●	●
RECLAIMED WATER				●	●	●
SECONDARY WATER					●	●
PRESSURE REGULATION		●	●	●	●	●
HIGH-PRESSURE SYSTEMS				●	●	●
LOW-PRESSURE SYSTEMS		●	●	●	●	●
HIGH-TEMPERATURE LOCATIONS				●	●	●
USE AS MASTER VALVE			●	●	●	●

VALVES

Advanced Features



ACCU SYNC PRESSURE REGULATORS

Available on:
PGV, ICV, IBV

Avoid sprinkler over-pressure conditions and gain significant water savings with Hunter's Accu Sync Pressure Regulator. This option is available in adjustable or fixed pressure models.



FILTER SENTRY MECHANISM

For use with:
ICV, IBV

The Filter Sentry Mechanism scours the filter clean twice during each valve cycle. Since it is attached to the diaphragm, the Filter Sentry feature can be easily added after a valve has been installed.



All Hunter valves are 100% water-tested to ensure reliable operation once installed.

From residential to commercial applications, high pressure to low pressure, and clean water to dirty water, Hunter valves keep systems running flawlessly day in and day out.

1" PGV AND PGV JAR-TOP



These versatile and robust valves offer simple serviceability.

KEY BENEFITS

- External/internal manual bleed allows for quick and easy activation at the valve
- Double-beaded diaphragm seal design ensures leak-free performance
- Captive bonnet screws eliminate the possibility of lost parts during disassembly
- Triple-tool bonnet screws are compatible with standard or Phillips screwdrivers as well as a nut driver
- Jar-top models provide easy access without tools
- Encapsulated solenoid with captive plunger used on every Hunter valve provides hassle-free service
- Flow control maximizes efficiency and prolongs the life of the system

USER-INSTALLED OPTIONS

- Accu Sync® Pressure Regulator at the valve*
- DC-Latching Solenoid for battery-operated controllers (P/N 458200)
- Solenoid conduit cover (P/N 464322)

FACTORY-INSTALLED OPTIONS

- LS: Valve without solenoid
- DC: DC-Latching Solenoid for battery-operated controllers; **see page 88**
- JT: Jar-top models

OPERATING SPECIFICATIONS

- Flow: 0.2 to 40 GPM
- Recommended pressure range: 20 to 150 PSI
- Temperature rating: 150°F
- Warranty period: 2 years

SOLENOID SPECIFICATIONS

- 24 VAC solenoid
 - 350 mA inrush, 190 mA holding, 60 Hz
 - 370 mA inrush, 210 mA holding, 50 Hz

* Accu Sync product information on **page 85**



PGV-100G VALVE

Inlet diameter: 1"
Height: 5"
Length: 4½"
Width: 2½"



PGV-101G VALVE

Inlet diameter: 1"
Height: 5"
Length: 4½"
Width: 2½"



PGV-100JT-G VALVE

Inlet diameter: 1"
Height: 5½"
Length: 4½"
Width: 3¼"



PGV-101JT-G VALVE

Inlet diameter: 1"
Height: 5½"
Length: 4½"
Width: 3¼"

Double-Beaded Diaphragm



Captive Bonnet Bolts



PGV - SPECIFICATION BUILDER : ORDER 1 + 2 + 3 + 4 + 5

1 Model	2 Standard Features	3 Feature Options	4 Options	5 User-Installed Options
PGV-100 = 1"	Globe valve, without flow control, threaded inlet/outlet	G = Female threaded inlet/ outlet	DC = DC-Latching Solenoid for battery-operated controllers	AS-ADJ = Adjustable Accu Sync Pressure Regulator
PGV-101 = 1"	Globe valve, with flow control, threaded inlet/outlet	G-S = Slip inlet /outlet MB = Male NPT inlet/ 1" poly barb outlet MB-075 = Male NPT inlet/ 3/4" poly barb outlet MB-125 = Male NPT inlet/ 1/4" poly barb outlet MM = Male NPT inlet/ Male NPT outlet	LS = Less solenoid Blank = No options	458200 = DC-Latching Solenoid for battery-operated controllers 269205 = Reclaimed flow control handle LIT-700 = Reclaimed ID tag
PGV-100-A = 1"	Angle valve, without flow control, threaded inlet/outlet	Blank = No options	Blank = No options	
PGV-101-A = 1"	Angle valve, with flow control, threaded inlet/outlet			

Example:
PGV-101-MM = 1" PGV globe valve, with flow control, with male NPT inlet and outlet

PGV JAR-TOP - SPECIFICATION BUILDER : ORDER 1 + 2 + 3 + 4 + 5

1 Model	2 Standard Features	3 Feature Options	4 Options	5 User-Installed Options
PGV-100-JT = 1"	Globe valve, without flow control, threaded inlet/outlet	G = Female threaded inlet/ outlet	DC = DC-Latching Solenoid for battery-operated controllers	AS-ADJ = Adjustable Accu Sync Pressure Regulator
PGV-101-JT = 1"	Globe valve, with flow control, threaded inlet/outlet	G-S = Slip inlet /outlet MB = Male NPT inlet/1" poly barb outlet MB-075 = Male NPT inlet/ 3/4" poly barb outlet MB-125 = Male NPT inlet/ 1/4" poly barb outlet MM = Male NPT inlet/ Male NPT outlet	LS = Less solenoid	458200 = DC-Latching Solenoid for battery-operated controllers 269205 = Reclaimed flow control handle LIT-700 = Reclaimed ID tag

Example:
PGV-101-JT-MM = 1" PGV globe valve, with jar-top bonnet, with flow control, with male NPT inlet and outlet

PGV PRESSURE LOSS IN PSI

GPM	Globe	Angle	Male x Male	Male x Barb
1	3	1	2	2
5	4	1	2	2
10	4	1	2	2
15	5	1	3	3
20	5	2	4	4
25	6	2	7	6
30	8	3	10	10
40	14	5	18	16

PGV-100G Valve Installed

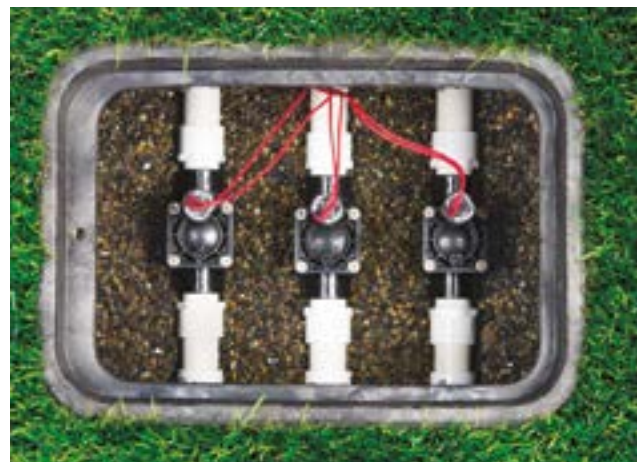

Gain simple and trouble-free operation without the need for a separate backflow preventer.

KEY BENEFITS

- External/internal manual bleed allows for quick and easy activation at the valve
- Double-beaded diaphragm seal design ensures leak-free performance
- Captive bonnet screws eliminate the possibility of lost parts during disassembly
- Triple-tool bonnet screws are compatible with standard or Phillips screwdrivers as well as a nut driver
- Removable anti-siphon cap for simple servicing
- Encapsulated solenoid with captive plunger used on every Hunter valve provides hassle-free service
- Flow control maximizes efficiency and prolongs the life of the system

USER-INSTALLED OPTIONS

- Accu Sync® Pressure Regulator at the valve*
- DC-Latching Solenoid for battery-operated controllers (P/N 458200)

FACTORY-INSTALLED OPTIONS

- LS: Valve without solenoid
- DC: DC-Latching Solenoid for battery-operated controllers; [see page 88](#)

OPERATING SPECIFICATIONS

- Flow: 0.2 to 40 GPM
- Recommended pressure range: 20 to 150 PSI
- Temperature rating: 150°F
- Warranty period: 2 years

* Accu Sync product information on [page 85](#)



PGV-075-ASV VALVE

Inlet diameter: 3/4"
Height: 5 1/2"
Length: 5 3/4"
Width: 2 1/2"



PGV-101-ASV VALVE

Inlet diameter: 1"
Height: 5 1/2"
Length: 6 1/4"
Width: 2 1/2"

Double-Beaded Diaphragm



PGV-ASV - SPECIFICATION BUILDER: ORDER 1 + 2 + 3 + 4

1	Model	2	Standard Features	3	Feature Options	4	User-Installed Options
	PGV-075-ASV = 3/4" PGV-101-ASV = 1"		Anti-siphon valve with flow control, threaded inlet/outlet		(blank) = No option DC = DC-Latching Solenoid for battery-operated controllers		AS-ADJ = Adjustable Accu Sync Pressure Regulator 458200 = DC-Latching Solenoid for battery-operated controllers
	PGV-075-ASV-S = 3/4" PGV-101-ASV-S = 1"		Anti-siphon valve with flow control, slip inlet/outlet		LS = Less solenoid		607105 = Reclaimed flow control handle LIT-700 = Reclaimed ID tag

PGV-ASV PRESSURE LOSS IN PSI

Flow (GPM)	3/4"	1"
1	1	1
5	2	2
10	2	2
15	3	3
20	6	6
25		6
30		9
35		16
40		20

Example:
PGV-101-ASV-S = 1" PGV anti-siphon valve with slip inlet and outlet



1½" AND 2" PGV

These reliable valves provide long-lasting performance for larger systems.

KEY BENEFITS

- External/internal manual bleed allows for quick and easy activation at the valve
- Double-beaded diaphragm seal design ensures leak-free performance
- Captive bonnet screws eliminate the possibility of lost parts during disassembly
- Triple-tool bonnet screws are compatible with standard or Phillips screwdrivers as well as a nut driver
- Each valve available with globe or angle configuration for convenient placement
- Encapsulated solenoid with captive plunger used on every Hunter valve provides hassle-free service
- Flow control maximizes efficiency and prolongs the life of the system

USER-INSTALLED OPTIONS

- Accu Sync® Pressure Regulator at the valve*
- DC-Latching Solenoid for battery-operated controllers (P/N 458200)
- Solenoid conduit cover (P/N 464322)
- Reclaimed flow control handle (P/N 607105)

FACTORY-INSTALLED OPTIONS

- LS: Valve without solenoid
- DC: DC-Latching Solenoid for battery-operated controllers; **see page 88**

OPERATING SPECIFICATIONS

- Flow:
 - PGV-151: 20 to 120 GPM
 - PGV-201: 20 to 150 GPM
- Recommended pressure range: 20 to 150 PSI
- Temperature rating: 150°F
- Warranty period: 2 years

SOLENOID SPECIFICATIONS

- 24 VAC solenoid
 - 350 mA inrush, 190 mA holding, 60 Hz
 - 370 mA inrush, 210 mA holding, 50 Hz

* Accu Sync product information on **page 85**



PGV-151 VALVE

Inlet diameter: 1½"
Height: 7½"
Length: 5¾"
Width: 4½"

PGV-201 VALVE

Inlet diameter: 2"
Height: 8"
Length: 6¾"
Width: 5¼"

VALVES

PGV Installed

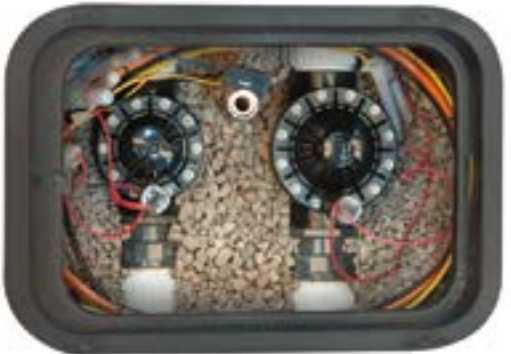

PGV-ASV – SPECIFICATION BUILDER: ORDER 1 + 2 + 3 + 4				
1	Model	2 Standard Features	3 Feature Options	4 User-Installed Options
PGV-151=1½"		Globe/angle valve with flow control	(blank) = No option DC = DC-Latching Solenoid for battery-operated controllers LS = Less solenoid	AS-ADJ = Adjustable Accu Sync Pressure Regulator 458200 = DC-Latching Solenoid for battery-operated controllers 607105 = Reclaimed flow control handle LIT-700 = Reclaimed ID tag
PGV-201=2"				

Example:
PGV-201-AS-ADJ = 2" PGV globe/angle valve with flow control, user-installed adjustable Accu Sync Pressure Regulator

PGV PRESSURE LOSS IN PSI				
Flow GPM	1½" Globe	1½" Angle	2" Globe	2" Angle
20	3	3	1	1
30	3	3	1	2
35	3	3	2	2
40	3	3	2	2
50	4	3.5	1	1
60	5	4	2	2
80	5.5	4.5	3	2
100	9	8	5	3
120	11.5	10.5	6	5
135			8	7
150			10	9

This dependable valve works seamlessly with highly demanding systems.

KEY BENEFITS

- Optional Filter Sentry® Mechanism scours the filter screen in dirty water conditions
- External/internal manual bleed allows for quick and easy activation at the valve
- Glass-filled nylon construction provides high pressure rating and reliability
- Double-beaded diaphragm seal design ensures leak-free performance
- Fabric-reinforced EPDM diaphragm and seat ensure greater performance in all water conditions
- Captive bonnet screws eliminate the possibility of lost parts during disassembly
- Triple-tool bonnet screws are compatible with standard or Phillips screwdrivers as well as a nut driver
- Encapsulated solenoid with captive plunger used on every Hunter valve provides hassle-free service
- Flow control maximizes efficiency and prolongs the life of the system

USER-INSTALLED OPTIONS

- Accu Sync® Pressure Regulator at the valve
- DC-Latching Solenoid for battery-operated controllers: P/N 458200
- Filter Sentry Mechanism easily added to an installed valve*
- Solenoid conduit cover: P/N 464322

FACTORY-INSTALLED OPTIONS

- LS: Valve without solenoid
- DC: DC-Latching Solenoid for battery-operated controllers; **see page 88**
- FS: Filter Sentry
- FS-R: Reclaimed option with Filter Sentry Mechanism, purple control knob, and purple, chlorine-resistant diaphragm (available only on 1½" and 2" models)

OPERATING SPECIFICATIONS

- Flow:
 - ICV-101G: 0.1 to 40 GPM
 - ICV-151G: 0.1 to 150 GPM
 - ICV-201G: 0.1 to 200 GPM
 - ICV-301: 0.1 to 300 GPM
- Recommended pressure range: 20 to 220 PSI
- Temperature rating: 150°F
- Warranty period: 5 years

SOLENOID SPECIFICATIONS

- 24 VAC solenoid
 - 350 mA inrush, 190 mA holding, 60 Hz
 - 370 mA inrush, 210 mA holding, 50 Hz

* Accu Sync product information on **page 85**



ICV-101G VALVE

Inlet diameter: 1"
Height: 5½"
Length: 4¾"
Width: 4"



ICV-151G VALVE

Inlet diameter: 1½"
Height: 7½"
Length: 6⅞"
Width: 5½"



ICV-201G VALVE

Inlet diameter: 2"
Height: 7⅞"
Length: 6⅞"
Width: 5½"



ICV-301 VALVE

Inlet diameter: 3"
Height: 10¾"
Length: 9"
Width: 7¾"



ICV-R VALVE

Inlet diameter: 1", 1½", 2", and 3"
Height: 7⅞"
Length: 6⅞"
Width: 5½"

Double-Beaded Diaphragm

Filter Sentry Mechanism



ICV 1", 1½", 2", & 3" - SPECIFICATION BUILDER: ORDER 1 + 2 + 3 + 4

1 Model	2 Standard Features	3 Feature Options	4 User-Installed Options
ICV-101G = 1" ICV-151G = 1½" ICV-201G = 2" ICV-301 = 3"	Globe valve with flow control Globe / Angle valve with flow control	(blank) = No option FS = Filter Sentry Mechanism FS-R = Purple reclaimed Filter Sentry Mechanism and ID tag (available only on 1½" and 2" models) DC = DC-Latching Solenoid for battery-operated controllers LS = Less solenoid	AS-ADJ = Adjustable Accu Sync Pressure Regulator 458200 = DC-Latching Solenoid for battery-operated controllers 561205 = Reclaimed flow control handle (1", 1½", 2" only) LIT-700 = Reclaimed ID tag

Example:
 ICV-201G-AS-ADJ = 2" ICV globe valve with flow control, user-installed adjustable Accu Sync Pressure Regulator

**ICV PRESSURE LOSS
 (AT OPTIMAL FLOWS) IN PSI**

Flow (GPM)	1" Globe	1½" Globe	2" Globe	3" Globe	3" Angle
0.1	2.0				
0.5	2.0				
1	2.0				
5	2.5				
10	3.0				
15	3.0				
20	3.0	1.5			
30	9.0	1.5			
40	20.0	1.7	0.8		
50		2.2	1.2		
60		3.0	1.7		
75		3.9	2.4		
90		5.5	3.2		
100		7.0	4.2		
120		10.9	6.5		
135		12.7	7.9		
150		16.2	9.8	2.5	1.9
175			13.3	3.0	2.4
200			17.7	4.1	3.3
225				5.3	4.3
250				6.7	5.5
275				8.3	6.9
300				10.1	8.5

Double-Beaded Chlorine-Resistant Diaphragm



Filter Sentry Mechanism

Captive Bonnet Bolts



Built of solid brass, this valve can power through the fiercest irrigation conditions.

KEY BENEFITS

- Factory-installed Filter Sentry® scours the filter screen in dirty water conditions
- External/internal manual bleed allows for quick and easy activation at the valve
- Heavy-duty brass construction provides high pressure rating and reliability
- Double-beaded diaphragm seal design ensures leak-free performance
- Fabric-reinforced EPDM diaphragm and seat ensure greater performance in all water conditions
- Triple-tool bonnet screws are compatible with standard or Phillips screwdrivers as well as a nut driver
- Encapsulated solenoid with captive plunger used on every Hunter valve provides hassle-free service
- Flow control maximizes efficiency and prolongs the life of the system



IBV-101G-FS VALVE
Inlet diameter: 1"
Height: 5¼"
Length: 4½"
Width: 3"



IBV-151G-FS VALVE
Inlet diameter: 1½"
Height: 6½"
Length: 6"



IBV-201G-FS VALVE
Inlet diameter: 2"
Height: 7"
Length: 6"
Width: 5¼"



IBV-301G-FS VALVE
Inlet diameter: 3"
Height: 9"
Length: 8½"
Width: 7"

USER-INSTALLED OPTIONS

- Accu Sync® Pressure Regulator at the valve*
- DC-Latching Solenoid for battery-operated controllers (P/N 458200)
- Solenoid conduit cover (P/N 464322)

FACTORY-INSTALLED OPTIONS

- DC: DC-Latching Solenoid for battery-operated controllers; **see page 88**

OPERATING SPECIFICATIONS

- Flow:
 - IBV-101G: 0.1 to 40 GPM
 - IBV-151G: 0.1 to 150 GPM
 - IBV-201G: 0.1 to 200 GPM
 - IBV-301G: 0.1 to 300 GPM
- Recommended pressure range: 20 to 220 PSI
- Temperature rating: 150°F
- Warranty period: 5 years

SOLENOID SPECIFICATIONS

- 24 VAC solenoid
- 350 mA inrush, 190 mA holding, 60 Hz
- 370 mA inrush, 210 mA holding, 50 Hz

* Accu Sync product information on **page 85**

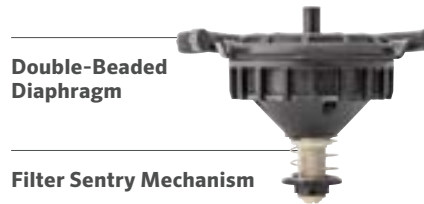

Double-Beaded Diaphragm

Filter Sentry Mechanism

IBV PRESSURE LOSS (AT OPTIMAL FLOWS) IN PSI

Flow GPM	1" Globe	1½" Globe	2" Globe	3" Globe
0.1	2.0			
0.5	2.0			
1	2.0			
5	2.5			
10	3.0			
15	3.0			
20	3.0	1.5		
30	4.0	1.5		
40	7.0	1.7	0.8	
50	2.2	1.2		
60	3.0	1.7		
75	3.9	2.4		
90	5.5	3.2		
100	7.0	4.2		
120	10.9	6.5		
135	12.7	7.9		
150	16.2	9.8	2.5	
175		13.3	3.0	
200		17.7	4.1	
225			5.3	
250			6.7	
275			8.3	
300			10.1	

Note:

Charts based on full-open flow-control position

IBV 1", 1½", 2" & 3" - SPECIFICATION BUILDER: ORDER 1 + 2 + 3 + 4			
1 Model	2 Standard Features	3 Feature Options	4 User-Installed Options
IBV-101G-FS = 1"	Brass globe valve with flow control, Filter Sentry Mechanism	(blank) = No option	AS-ADJ = Adjustable Accu Sync Pressure Regulator 458200 = DC-Latching Solenoid for battery-operated controllers 899605 = Reclaimed flow control handle LIT-700 = Reclaimed ID tag
IBV-151G-FS = 1½"		R = Purple reclaimed Filter Sentry Mechanism and ID tag (available only on 1½" and 2" models)	
IBV-201G-FS = 2"		DC = DC-Latching Solenoid for battery-operated controllers	
IBV-301G-FS = 3"		LS = Less solenoid	

Examples:

IBV-201G-FS-AS-ADJ = 2" IBV brass globe valve with flow control, Filter Sentry Mechanism, user-installed adjustable Accu Sync Pressure Regulator

ACCU SYNC® PRESSURE REGULATOR

These robust solutions provide a simple way to achieve unparalleled pressure regulation for optimal performance.

OPERATING SPECIFICATIONS

- Regulation from 20 to 100 PSI
- Static pressure: 150 PSI
- Required dynamic pressure differential: 15 PSI
- Works with AC and DC-Latching Solenoids
- Works with any Hunter valve
- Warranty period: 2 years

ACCU SYNC VALVE RECOMMENDED FLOW RANGE	
Valve	Flow GPM
PGV-100/101	15 to 40
PGV-151	20 to 120
PGV-201	40 to 150
ICV-101	15 to 40
ICV-151	20 to 150
ICV-201	40 to 200
ICV-301	150 to 300
IBV-101	15 to 40
IBV-151	20 to 150
IBV-201	40 to 200
IBV-301	150 to 300

ACCU SYNC APPLICATIONS	
● Adjustable 20-100 PSI	For full customization, the adjustable Accu Sync can regulate pressure from 20 to 100 PSI

ACCU SYNC PRESSURE REGULATOR – SPECIFICATION BUILDER: ORDER 1 + 2	
1 Model	2 Inlet/Outlet
ACCU SYNC	ADJ = Adjustable Pressure Regulator (20-100 PSI)

Example:
ICV-201G-B-AS-ADJ = 2" ICV globe valve with flow control, user-installed adjustable Accu Sync Pressure Regulator

ADJUSTABLE



**ACCUSYNC-ADJ
PRESSURE REGULATOR**
Height with solenoid: 3¼"

ADAPTER



SOLENOID ADAPTER



AC Solenoid
P/N 606800: Includes one red (common) and one red (station) wire

QUICK COUPLERS

The sturdy red brass and stainless steel construction of Quick Couplers strengthens any project.

KEY BENEFITS

- 100% interchangeable with major brands
- Red brass and stainless steel construction
- Heavy-duty thermoplastic locking and non-locking covers
- Optional winged stabilization and Acme key connection
- Stainless steel lug on 1" and 1¼" keys
- Spring-loaded covers with stainless steel springs for positive closing and protection of valve's sealing components
- Warranty period: 5 years
- See the SnapLok combo kits on [page 31](#)



Quick Couplers

QUICK COUPLER, KEY, AND HOSE SWIVEL CHARTS

Model	Inlet Threads	Slots	Body	Color*	Locking	Key	Swivels
HQ-3-RC	¾"	2	1-piece	Yellow	No	HK-33	HS-0
HQ-33-DRC	¾"	2	2-piece	Yellow	No	HK-33	HS-0
HQ-33-DLRC	¾"	2	2-piece	Yellow	Yes	HK-33	HS-0
HQ-44-RC	1" NPT	1	2-piece	Yellow	No	HK-44	HS-1 or HS-2
HQ-44-LRC	1" NPT	1	2-piece	Yellow	Yes	HK-44	HS-1 or HS-2
HQ-44-RC-AW	1" NPT	Acme	2-piece wing**	Yellow	No	HK-44A	HS-1 or HS-2
HQ-44-LRC-AW	1" NPT	Acme	2-piece wing**	Yellow	Yes	HK-44A	HS-1 or HS-2
HQ-5-RC	1" NPT	1	1-piece	Yellow	No	HK-55	HS-1 or HS-2
HQ-5-LRC	1" NPT	1	1-piece	Yellow	Yes	HK-55	HS-1 or HS-2

Notes:

* All locking cover models are available with purple covers for reclaimed water applications.

** Anti-rotation stabilization wings.



Reclaimed Water Option

All locking models have an optional purple cover for sites using reclaimed water.

QUICK COUPLER – SPECIFICATION BUILDER: ORDER 1 + 2 + 3

1 Model	2 Cover Options	3 Additional Options
<p>HQ-3 = ¾" inlet, 1-piece body, 2 slots</p> <p>HQ-5 = 1" inlet, 1-piece body, 1 slot</p> <p>HQ-33-D = ¾" inlet, 2-piece body, 2 slots</p> <p>HQ-44 = 1" inlet, 2-piece body, 1 slot or Acme key socket</p>	<p>RC = Yellow rubber cover</p> <p>LRC = Yellow locking rubber cover <i>(Not available for HQ-3 body)</i></p>	<p>(blank) = No option</p> <p>AW = Acme key with anti-rotation wings <i>(Only available for HQ-44 body)</i></p> <p>R = Purple locking cover <i>(reclaimed water ID; only available for LRC models)</i></p>

Examples:

HQ-3-RC = HQ-3 valve with rubber cover

HQ-44-LRC = HQ-44 valve with locking rubber cover

HQ-44-LRC-R = HQ-44 valve with locking rubber cover and reclaimed water ID

HQ-44-LRC-AW-R = HQ-44 valve, with locking rubber cover, Acme key socket with anti-rotation wings and reclaimed water ID

KEYS

Model	Compatible Valve	Compatible Swivel
HK-33 = ¾" valve, ¾" key inlet	HQ-3, HQ-33	HS-0
HK-44 = 1" valve, 1" key inlet	HQ-44	HS-1, HS-2
HK-44A = 1" valve, Acme key inlet	HQ-44-AW	HS-1, HS-2
HK-55 = 1" valve, 1¼" key inlet	HQ-5	HS-1, HS-2

HS HOSE SWIVELS

Model	Compatible Key
HS-0 = ¾" inlet, ¾" hose outlet	HK-33
HS-1 = 1" inlet, ¾" hose outlet	HK-44, HK-44A, HK-55
HS-2 = 1" inlet, 1" hose outlet	HK-44, HK-44A, HK-55

HQ PRESSURE LOSS IN PSI

Flow (GPM)	HQ-3	HQ-33	HQ-44	HQ-5
5	0.8	1.0		
10	1.8	2.0		
15	4.1	4.3	2.2	
20	7.2	7.6	4.4	1.0
30			11.5	3.0
40				6.3
50				9.2
60				13.0
70				19.8



DC-LATCHING SOLENOID

This versatile solenoid enables valve operation with battery-operated controllers.

KEY BENEFITS

- Compatible with all Hunter irrigation valves
- Compatible with NODE, NODE-BT, and XC Hybrid systems
- Captive plunger offers easy servicing of solenoid
- Manual quarter-turn on/off control

OPERATING SPECIFICATIONS

- Minimum opening/operating voltage: 6 VDC
- Maximum recommended voltage: 9 VDC
- Coil resistance: 4.8 ohms nominal
- Pulse width: 250 milliseconds
- Wire leads: 22" of 18 AWG black/red UL-approved wire

Note: See battery-operated controller product pages for wiring distances



DC-Latching Solenoid

P/N 458200: One black (common) wire and one red (station) wire

AC SOLENOID

The standard solenoid for all electric controllers.

KEY BENEFITS

- Compatible with all Hunter irrigation valves
- Captive plunger offers easy servicing of solenoid
- Manual quarter-turn on/off control
- Wire leads: 14" of 18 AWG red UL-approved wire

OPERATING SPECIFICATIONS

- Minimum operating voltage: 20.5 VAC
- Maximum recommended voltage: 24 VAC
 - 350 mA inrush, 190 mA holding, 60 HZ
 - 370 mA inrush, 210 mA holding, 50 HZ
- Coil resistance: 23 to 28 ohms nominal



AC Solenoid

P/N 606800: One red (common) and one red (station) wire



HUNTER VALVES

BUILT TO THRIVE UNDER PRESSURE

From residential to commercial applications, high pressure to low pressure, and clean water to dirty water, Hunter valves keep your system running flawlessly day in and day out.

ULTIMATE RELIABILITY

- Fewer parts means greater longevity and simple operation
- AC and DC models for flexibility
- Residential models handle up to 150 PSI
- Commercial models handle up to 220 PSI

SIMPLE PRESSURE REGULATION

- Regulating at the valve greatly enhances efficiency
- Accu Sync® Pressure Regulators provide simple regulation from 20 to 100 PSI



CONTROLLERS

CONTROLLER

SELECTION GUIDE

Platform

AC-Powered Controllers

STANDARD

Details on [page 94](#)

Dial-based controllers are standalone systems that offer water-saving features and convenient remote control operation for faster maintenance.

X-Core®
Stations: 2, 4, 6, 8
[page 95](#)



HYDRAWISE®

Details on [page 98](#)

The Wi-Fi controller solution designed for contractors. The Hydrowise Irrigation Management Platform is simple to set up, easy to use, and packed with helpful remote irrigation management features. Built-in system monitoring and a suite of powerful tools make saving water and managing multiple sites easy.

X2™
Stations: 4, 6, 8, 14
[page 100](#)



X2 with WAND
Stations: 4, 6, 8, 14
[page 101](#)



Pro-HC
Stations: 6, 12, 24
[page 102](#)



HPC
Stations: 4 to 32
[page 103](#)



HCC
Stations: 8 to 54
[page 104](#)



CENTRALUS™

Details on [page 108](#)

Gain cloud-based control and monitoring for Pro-C, ICC2, and ACC2 Controllers with the mobile-friendly Centralus Irrigation Management Platform.

Pro-C®
Stations: 4 to 32
[page 113](#)



ICC2
Stations: 8 to 54
[page 112](#)



ACC2
Stations: 12 to 54 conventional, 1 to 225 with two-wire
[page 110](#)



Use this guide to quickly compare Hunter controller power needs, station counts, and software platforms to ensure you choose the best controller for every installation.

Platform

Battery-Operated Controllers

INDEPENDENT

Details on [page 115](#)

Battery-operated controllers allow automatic irrigation for power-restricted valve locations and areas where hardscape blocks the ability to run wire affordably.

NODE

Stations: 1, 2, 4, 6
page 118



XC Hybrid

Stations: 6, 12
page 120



BLUETOOTH®

Details on [page 115](#)

Bluetooth-enabled, battery-operated controllers have all the benefits of independent battery controllers with convenient, on-site wireless control from a smartphone.

BTT

Zones: 1, 2
page 117



NODE-BT

Stations: 1, 2, 4
page 119



The Wireless Valve Link uses LoRa® Technology so you can connect valves without running costly wires or cutting into hardscape.



With the two-wire option, you can easily expand the system as needed after installation.

STANDARD CONTROLLERS

STANDARD CONTROLLERS



X-CORE®

Perfect for tract homes and entry-level residential systems, this simple and intuitive controller provides basic irrigation capabilities with convenient add-on options for smart watering adjustments and remote operation.

KEY BENEFITS

- Number of stations:
 - 2, 4, 6, or 8 (fixed models)
 - Separate indoor and outdoor models for a variety of installation environments
- 3 automatic programs with 4 start times per program, and up to 4-hour run times per station
- Add a Solar Sync® Sensor to save water based on local weather conditions
- QuickCheck™ Technology provides simple diagnostics of faulty field wiring
- Hide Programs setting shows 1 program and 1 start time for simplification
- Short-circuit protection detects wiring faults and skips the station without system damage
- Easy Retrieve® Memory backs up the full irrigation schedule
- Delay Between Stations for slow-closing valves or pump recharge
- Cycle and Soak prevents water waste and runoff in areas with elevation changes or tight soils
- Seasonal adjustment for quicker schedule adjustments without changing run times

OPERATING SPECIFICATIONS

- Transformer input: 120 VAC
- Transformer output (24 VAC): 1 A
- Station output (24 VAC): 0.56 A
- P/MV output (24 VAC): 0.28 A
- Sensor inputs: 1
- Approvals: Plastic IP54 (outdoor), UL, cUL, FCC, CE, UKCA, RCM, ISED
- Warranty period: 2 years



Plastic Indoor

Height: 6½"
Width: 5¾"
Depth: 2"



Plastic Outdoor

Height: 8¾"
Width: 7"
Depth: 3¾"

Compatible with:



**Solar Sync
Sensor**
Page 140



ROAM Remote
Page 130
ROAM XL Remote
Page 131

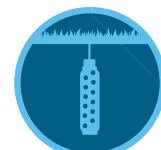

**Soil-Clik
Sensor**
Page 141

X-CORE	
Model	Description
XC-200i	Fixed 2-station, plastic indoor wall mount
XC-400i	Fixed 4-station, plastic indoor wall mount
XC-400	Fixed 4-station, plastic outdoor wall mount with plug
XC-600i	Fixed 6-station, plastic indoor wall mount
XC-600	Fixed 6-station, plastic outdoor wall mount with plug
XC-800i	Fixed 8-station, plastic indoor wall mount
XC-800	Fixed 8-station, plastic outdoor wall mount with plug



EPA WaterSense®

Recognized as a responsible water-saving tool when used with a Solar Sync Sensor



HYDRAWISE[®] CONTROLLERS



A healthy, beautiful landscape needs just the right amount of water to thrive. The Hydrowise Irrigation Management Platform automatically adjusts your irrigation according to local weather. Choose from a complete lineup of Hydrowise-enabled controllers to maximize water and money savings in any setting.

HYDRAWISE CONTROLLER COMPARISON CHART

CONTROLLER MODELS	MAXIMUM STATIONS	SENSOR INPUTS	TWO-WIRE	REMOTE CONTROL	WEB ACCESS	FLOW
X2	14	1	N/A	ROAM, ROAM XL, Hydrowise App	Hydrowise: Wi-Fi (WAND Module)	N/A
X2 with WAND	14	1	N/A	ROAM, ROAM XL, Hydrowise App	Hydrowise: Wi-Fi	N/A
PRO-HC	24	2	N/A	Hydrowise App	Hydrowise: Wi-Fi	HC Flow Meter (wired or wireless)
HPC	32	2	EZDS	ROAM, ROAM XL, Hydrowise App	Hydrowise: Wi-Fi	HC Flow Meter (wired or wireless)
HCC	54	2	EZDS	ROAM, ROAM XL, Hydrowise App	Hydrowise: Wi-Fi	HC Flow Meter (wired or wireless)

HYDRAWISE® SOFTWARE

As the industry's best Wi-Fi control solution, the Hydrowise Irrigation Management Platform allows for professional multi-site management and provides a range of helpful water-saving features for end users.



Save Water

PREDICTIVE WATERING®

Predictive Watering Technology uses past, current, and forecast weather data sourced from the internet to automatically adjust to local, real-time conditions and provide homeowners and end users with tremendous water savings.

VIRTUAL SOLAR SYNC®

Virtual Solar Sync uses daily ET measurements from your selected weather stations to supplement the Predictive Watering adjustments on your controller, working to save even more water.



Protect the Landscape

SYSTEM MONITORING

Flow rate and valve monitoring alert you in the event of a problem, so you can quickly prevent landscape degradation before significant damage occurs.

WEATHER MONITORING

Web-based climate monitoring automatically adjusts irrigation systems to local weather conditions, ensuring plants remain healthy — rain or shine.



Save Time and Labor

REMOTE MANAGEMENT

Make changes to a program and know the status of the controller and the irrigation plan without a site visit.

STORE CUSTOMER PLANS AND DESIGNS

Attach irrigation system layouts to your customers' controllers for quick reference in the field. Never forget the location of the pipes or valve box again.

ON-SITE REMOTE

Turn your smartphone into a remote control to make changes and check the irrigation system without visiting the controller.

All trademarks are property of their respective owners.



Build a Stronger Business

BUILD A STRONGER BUSINESS

Add services, grow revenue, increase customer satisfaction, and rest assured that Hydrowise has your back as you expand your business.

BUSINESS BRANDING

Gain instant recognition from your customers by including your business logo and details in your Hydrowise account.

MULTI-SITE MANAGER

Manage many customers or multiple sites with our unique business tools:

- Summary of all controllers
- List view of customers/sites
- Search for customers and controllers
- View all controller events and logs
- View all controller alerts
- Branded automatic email reporting to customers
- Global control settings
 - Alerts
 - Watering Schedules
 - Start Times
 - Watering Triggers
- Quick select controllers
- Generate job sheets
- Manage subcontractors or regions

BUSINESS ACCOUNT

Manage staff access with different levels of permission. Remove or add staff easily and quickly. Add and store files, irrigation plans, layouts, or other documents for access by your staff.

MESSAGING

Receive messages from and send messages to customers and staff through the Hydrowise App.



Manage from Anywhere

GLOBAL APP AND WEB ACCESS

Sit back and relax. With Hydrowise, everything you need is in the palm of your hand. Remote access allows you to view, manage, and monitor irrigation controllers from your smartphone, tablet, or computer at your convenience.

SMART-HOME COMPATIBILITY

Hydrowise integrates seamlessly with Amazon Alexa™, Control4®, and HomeSeer™.

What's New with Hydrawise



- HPC Controller now compatible with the EZ Decoder System up to 32 stations
- HPC Controller has two sensors ports for any Klik Sensor and HC Flow Meter
- Create custom reports for water savings and forecasts; automatically email them to your customers
- WAND Module for X2 Controllers provides super-fast Bluetooth remote, Wi-Fi setup, and a convenient copy-paste schedule function
- Controller touchscreen enhancements



Access to Hydrawise Software is free for all users worldwide.
To learn more, visit hydrawise.com.



EPA WaterSense® Approved

Recognized as a responsible water-saving tool by the U.S. Environmental Protection Agency



X2 Controller with WAND Module

4-, 6-, 8-, and 14-station count



Pro-HC Controller

6-, 12-, and 24-station count



HPC Controller

4- to 32-station count, EZDS two-wire option



HCC Controller

8- to 54-station count, EZDS two-wire option, Wireless Valve Link (WVL) compatible



HC Flow Meter

Add an optional flow meter to receive flow alerts and monitor water consumption

Not available for X2 Controller

X2™

This online-capable controller offers Rapid Programming™ Technology and advanced water-saving features.

KEY BENEFITS

- Number of stations:
 - 4, 6, 8, or 14 (fixed models)
- Wi-Fi capable controller automatically managed by Hydrawise® Software
- Backlit display provides optimal visibility in any light
- 3 flexible programs with 4 start times each and up to 6-hour run times
- QuickCheck™ Technology provides simple diagnostics of faulty field wiring
- Pre-wired with 48" lead and plug
- Hide Programs option shows one program and one start time for simplification
- Suspend irrigation up to 99 days during the off-season
- Short-circuit protection detects wiring faults and skips the station without system damage
- Easy Retrieve® Memory backs up the full irrigation schedule
- Delay Between Stations for slow-closing valves or pump recharge
- Cycle and Soak prevents water waste and runoff in areas with elevation changes or tight soils
- Seasonal adjustment for quicker schedule updates without changing run times

OPERATING SPECIFICATIONS

- Transformer input: 120 VAC
- Transformer output (24 VAC): 1 A
- Station output (24 VAC): 0.56 A
- P/MV output (24 VAC): 0.28 A
- Sensor inputs: 1
- Approvals (controller): Plastic IP55 (outdoor), UL, cUL, FCC, CE, UKCA, RCM, ISED
- Warranty period: 2 years



X2
Height: 9"
Width: 7½"
Depth: 3½"

X2	
Model	Description
X2-400	Fixed 4-station, plastic outdoor wall mount with plug
X2-600	Fixed 6-station, plastic outdoor wall mount with plug
X2-800	Fixed 8-station, plastic outdoor wall mount with plug
X2-1400	Fixed 14-station, plastic outdoor wall mount with plug

Compatible with:



**Hydrawise
Software**
Page 98



**Rain-Clik®
Sensor**
Page 138



ROAM Remote
Page 130
ROAM XL Remote
Page 131

WAND FOR X2™

This Wi-Fi upgrade option connects the X2 Controller to Hydrowise Software, giving it remote management capabilities from anywhere with an internet connection.

KEY BENEFITS

- Simple Wi-Fi plug-in enables remote irrigation management with any X2 Controller
- WAND Technology provides easy online irrigation management with controller status and faulty wiring alerts
- Standard programming allows for 3 independent programs featuring 6 start times each and 24-hour maximum run times
- Rapid Programming™ Technology lets you send preprogrammed schedules to any X2 Controller in seconds, so you get jobs done quicker
- Predictive Watering® Technology provides precise weather adjustments for maximum water savings
- Compatibility with Amazon Alexa™, Control4®, and HomeSeer™ home automation technology enables simple, centralized voice control of the irrigation system
- Bluetooth Wi-Fi setup or WPS push-button connection makes it easy to connect to a wireless network
- WAND Module sold separately from X2 Controller

OPERATING SPECIFICATIONS

- Flexible setup options: Bluetooth® Wi-Fi tether, Wi-Fi direct, or WPS push-button connection
- Bluetooth 5.0
- 2.4 GHz (only) Wi-Fi router compatible, 802.11 b/g/n 20 MHz
- Supported security protocols: WPA/WPA2 Personal (only), TLS
- Approvals: UL, cUL, FCC, CE, UKCA, RCM, ISED
- Warranty period: 2 years

WAND MODULE

Model	Description
WAND	Bluetooth and Wi-Fi Module for X2 Controllers

WAND INSTALLATION



The Bluetooth® word mark and logos are registered trademarks owned by Bluetooth SIG Inc., and any use of such marks by Hunter Industries is under license. Amazon Alexa is a trademark of Amazon.com Inc. or its affiliates. Control4 is a registered trademark of Control4 Corporation in the United States and/or other countries. HomeSeer is a trademark of HomeSeer Technologies LLC.

Try Hydrowise Software today at hydrowise.com.



WAND Module

Height: ¾"
Width: 2½"
Depth: 2½"



WAND Module installed in the X2 Controller

Compatible with:



X2 Controller
Page 100



EPA WaterSense® Approved

Recognized as a responsible water-saving tool by the U.S. Environmental Protection Agency

PRO-HC

Use this rugged, cost-effective, and professional-grade Wi-Fi controller for residential and light commercial applications.

Try Hydrawise Software today at hydrawise.com.

KEY BENEFITS

- Number of stations:
 - 6, 12, or 24 (fixed models)
- Standard programming option allows for 6 independent irrigation programs and 6 start times per program
- 2 sensor inputs available for use with any Clik Sensor and HC Flow Meter
- 1 P/MV output for pump start relay and master valve activation
- Wi-Fi enabled for quick connection to Hydrawise® Software
- 2¾" full-color touchscreen display for Wi-Fi setup, zone testing, and offline programming at the control panel
- Built-in milliamp sensor for wire fault detection and alerts

OPERATING SPECIFICATIONS

- Transformer input: 120 VAC
- Transformer output (24 VAC): 1 A
- Controller maximum current draw: 0.8 A
- Station output (24 VAC): 0.56 A
- P/MV output (24 VAC): 0.28 A
- 2.4 GHz (only) Wi-Fi router compatible, 802.11 b/g/n 20 MHz
- Supported security protocols: WPA/WPA2 Personal (only), TLS
- Approvals: IP44 (outdoor), UL, cUL, FCC, CE, UKCA, RCM, ISED
- Warranty period: 2 years

USER-INSTALLED OPTIONS

- Wireless HC Flow Meter option permits wireless flow monitoring for Hydrawise-enabled systems



Pro-HC

(indoor/outdoor)
Height: 9"
Width: 10"
Depth: 4"

Compatible with:

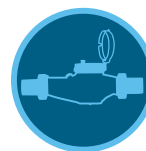

HC Flow Meter
Page 142



Rain-Clik Sensor
Page 138



PXSUNC Accessory
Visit fxl.com



EPA WaterSense® Approved

Recognized as a responsible water-saving tool by the U.S. Environmental Protection Agency

PRO-HC	
Model	Description
PHC-600	Fixed 6-station, plastic outdoor wall mount
PHC-1200	Fixed 12-station, plastic outdoor wall mount
PHC-2400	Fixed 24-station, plastic outdoor wall mount

HPC

This smart and flexible control solution combines the modularity of the popular Pro-C® Controller with the power of Hydrawise® Software.

Try Hydrawise Software today at hydrawise.com.

KEY BENEFITS

- Number of stations:
 - Conventional wiring from 4 to 23 stations
 - Hybrid EZ Decoder System option up to 32 total stations (28 stations maximum if two-wire only)
- Standard programming option allows for 6 independent irrigation programs and 6 start times per program
- 2 sensor inputs available for use with any Clik Sensor and HC Flow Meter
- 1 P/MV output for pump start relay and master valve activation
- Wi-Fi enabled for quick connection to Hydrawise Software
- 2¾" full-color touchscreen display for Wi-Fi setup, zone testing, and offline programming at the control panel
- Built-in milliamp sensor for wire fault detection and alerts

OPERATING SPECIFICATIONS

- Transformer input: 120 VAC
- Transformer output (24 VAC): 1 A
- Controller maximum current draw: 0.8 A
- Station output (24 VAC): 0.56 A
- P/MV output (24 VAC): 0.28 A
- 2.4 GHz (only) Wi-Fi router compatible, 802.11 b/g/n 20 MHz
- Supported security protocols: WPA/WPA2 Personal (only), TLS
- Approvals: IP44 (outdoor), UL, cUL, FCC, CE, UKCA, RCM, ISED
- Warranty period: 2 years

USER-INSTALLED OPTIONS

- Wireless HC Flow Meter option permits wireless flow monitoring for Hydrawise-enabled systems



HPC
(indoor/outdoor)
Height: 9"
Width: 10"
Depth: 4½"



HPC Face Panel

HPC	
Model	Description
HPC-400	Modular 4-station base, plastic outdoor wall mount with plug
HPC-FP	Hydrawise retrofit face panel for Pro-C Controllers (March 2014 or newer models)

PC-SERIES STATION EXPANSION	
Model	Description
PCM-300	3-station plug-in module
PCM-900	9-station plug-in module
PCM-1600	16-station plug-in module
PC-DM	EZ Decoder output module

Compatible with:

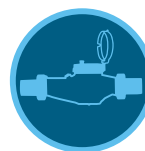

HC Flow Meter
Page 142



ROAM Remote
Page 130
ROAM XL Remote
Page 131

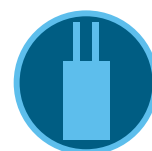

EZ Decoder System
Page 126



EPA WaterSense® Approved

Recognized as a responsible water-saving tool by the U.S. Environmental Protection Agency

HCC

Bring the power of Hydrawise® Software to residential, commercial, and public-sector projects with this affordable powerhouse.

Try Hydrawise Software today at hydrawise.com

KEY BENEFITS

- Number of stations:
 - Conventional: 8 to 38 (plastic), 8 to 54 (metal and pedestal)
 - With two-wire EZDS: Up to 54 (all enclosure options)
 - With Wireless Valve Link (WVL): up to 54 (all enclosure options)
- Standard programming option allows for 6 independent irrigation programs and 6 start times per program
- Any 2 programs can operate simultaneously to improve irrigation efficiency
- 2 sensor inputs available for use with any Clik Sensors and HC Flow Meter
- 1 P/MV output for pump start relay and master valve activation
- Wi-Fi enabled for quick connection to Hydrawise Software
- 3¼" full-color touchscreen display for Wi-Fi setup, zone testing, and offline programming at the control panel
- Built-in milliamp sensor for wire fault detection and alerts

OPERATING SPECIFICATIONS

- Transformer input: 120/230 VAC
- Transformer output (24 VAC): 1.4 A
- Controller max. current draw: 1.2 A
- Station output (24 VAC): 0.56 A
- P/MV output (24 VAC): 0.56 A
- 2.4 GHz (only) Wi-Fi router compatible, 802.11 b/g/n 20 MHz
- Run a maximum of 4 Hunter solenoids 1.04 A at once
- Supported security protocols: WPA/WPA2 Personal (only) TLS
- Approvals: Plastic Wall Mount IP55 (outdoor), Plastic Pedestal IP24 (outdoor), UL, cUL, FCC, CE, UKCA, RCM, ISED
- Warranty period: 2 years

USER-INSTALLED OPTIONS

- Wireless HC Flow Meter option permits wireless flow monitoring for Hydrawise-enabled systems
- Compatible with ROAM Remote and ROAM XL Remote; **see pages 130 and 131**



Plastic

Height: 12"
Width: 13¾"
Depth: 5"

Metal

(gray or stainless steel)
Height: 16"
Width: 13"
Depth: 5"



Metal Pedestal

(gray or stainless steel)
Height: 36"
Width: 11½"
Depth: 5"

Plastic Pedestal

Height: 39"
Width: 24"
Depth: 17"

HCC	
Model	Description
HCC-800-PL	8-station base model, plastic outdoor, wall mount
HCC-800-M	8-station base model, gray metal outdoor, wall mount
HCC-800-SS	8-station base model, stainless steel, wall mount
HCC-800-PP	8-station base model, plastic pedestal
HCC-FPUP	Retrofit Upgrade Kit for ICC and ICC2 Controllers
ICC-PED	Gray pedestal for metal wall mount cabinet
ICC-PED-SS	Stainless steel pedestal for stainless steel wall mount
ICC-PWB	Optional pedestal wiring board for metal pedestals
ANT-EXT-KIT	Universal Antenna Extension Kit

HCC SERIES STATION EXPANSION	
Model	Description
ICM-400	4-station plug-in module with enhanced surge protection
ICM-800	8-station plug-in module with enhanced surge protection
ICM-2200	22-station expansion module (maximum one per controller)
EZDS	See page 126 for model chart
WVL	See page 122 for model chart

Compatible with:

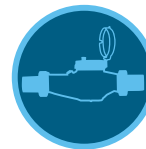

HC Flow Meter
Page 142



Wireless Valve Link
Page 122

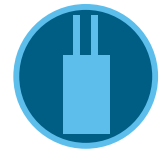

EZ Decoder System
Page 126



EPA WaterSense® Approved

Recognized as a responsible water-saving tool by the U.S. Environmental Protection Agency

WI-FI SYSTEM OVERVIEW

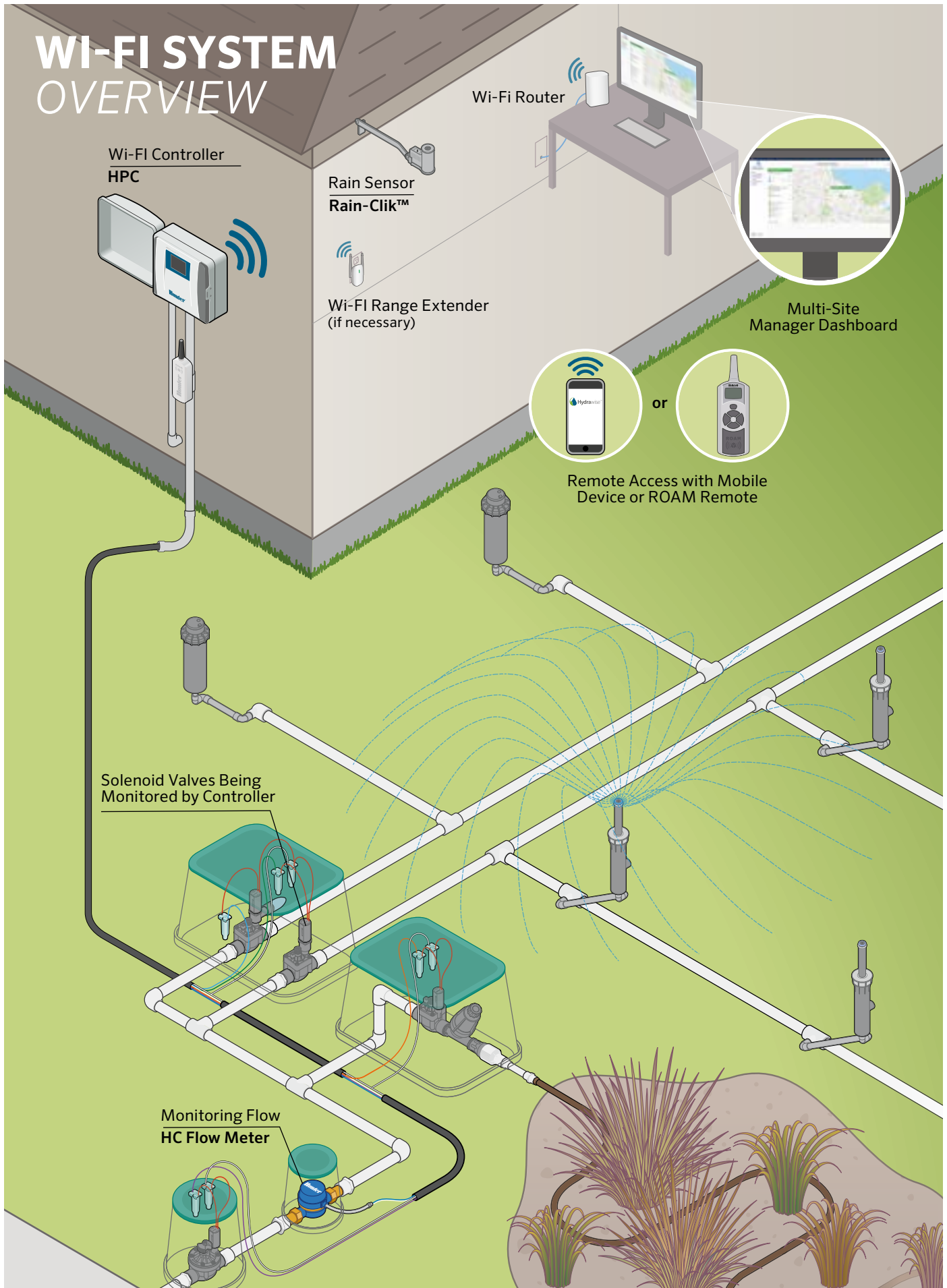



CENTRALUS™ CONTROLLERS



Manage large, complex systems from your fingertips with the cloud-based Centralus Irrigation Management Platform. Simple plug-in communication modules provide powerful internet connectivity and mobile control for Hunter's commercial-grade ACC2, ICC2, and Pro-C® Controllers.

CENTRALUS CONTROLLER COMPARISON CHART

CONTROLLER MODELS	MAXIMUM STATIONS	SENSOR INPUTS	TWO-WIRE	FLOW*	REMOTE CONTROL	WEB ACCESS
ACC2	54, 225 two-wire	3 Clik, 1 Solar Sync®, 6 Flow	ICD, 225 stations	HFS, WFS	ROAM, ROAM XL, Smartphone	Centralus: Wi-Fi, LAN, LTE
ICC2	54	1 Clik or Solar Sync, 1 Flow	EZDS, 54 stations	HFS, WFS, HC Flow Meter	ROAM, ROAM XL, Smartphone	Centralus: Wi-Fi, LAN, LTE
Pro-C	32	1 Clik, 1 Solar Sync or Flow	EZDS, 28 stations	FS, HFS, WFS, HC Flow Meter	ROAM, ROAM XL, Smartphone	Centralus: Wi-Fi

*Centralus communication module required for flow sensor input with Pro-C and ICC2 Controllers

CENTRALUS™ SOFTWARE

Add cloud-based control and monitoring for Pro-C®, ICC2, and ACC2 Controllers with the mobile-friendly Centralus Irrigation Management Platform.

KEY BENEFITS

- Browser-based programming and communication software
- Highly secure cloud access
- Map-based navigation and status
- Instant remote control from mobile device
- Flow monitoring and reporting
- Alarm reporting and detailed irrigation history reports
- Responsive web design configures for your device, allowing the same controls from your smartphone, tablet, or desktop
- Operable in many international languages
- Wi-Fi, LAN (Ethernet), or LTE connectivity options
- Manage Solar Sync® Sensor adjustments and delay settings for greater water savings
- Professional crewmember administration with multiple levels of access
- Organize maintenance teams and their controllers into management groups

OPERATING SPECIFICATIONS

- Operates in most modern browsers
- Secure internet connection for web-hosted application

USER-INSTALLED OPTIONS

- ET-based Solar Sync Sensor (one per controller); **see page 140**
- Flow sensors including the Flow-Sync® Sensor, Wireless Flow Sensor, HC Flow Meter, and other approved equals
- Connected controllers are compatible with license-free ROAM/ROAM XL Remote control (pre-wired controller connection)

COMMUNICATION OPTIONS

- LAN (Ethernet) with RJ-45 connection, low data requirements
- 2.4 GHz (only) Wi-Fi router compatible, 802.11 b/g/n
- Supported security protocols: WPA/WPA2 Personal (only), TLS
- Cellular connectivity with with ICC2 and ACC2 Controllers

COMMUNICATIONS	
Model	Description
PC-WIFI	Pro-C Wi-Fi connection
WIFIKIT	ICC2 Wi-Fi connection
LANKIT	ICC2 LAN (Ethernet) connection
CELLKIT	ICC2 cellular connection (service plan required)
A2C-WIFI	ACC2 Wi-Fi connection
A2C-LAN	ACC2 LAN (Ethernet) connection
A2C-LTEM	Cellular communication module for ACC2 (service plan required)

COMMUNICATIONS ACCESSORIES	
Model	Description
ANT-EXT-KIT	Universal Antenna Extension Kit

View Centralus Software today at centralus.hunterindustries.com.

ACC2 COMMUNICATION MODULE INSTALLATION



A2C Communication Modules are installed behind the ACC2 Facepack

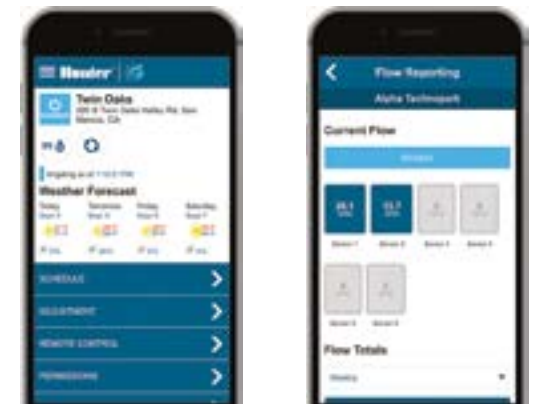

Manage and monitor controllers from anywhere



Mobile-Friendly

The mobile-friendly Centralus Irrigation Management Platform provides highly secure, comprehensive cloud-based control and monitoring features. The connectivity allows you to view a controller's status, change settings, view forecasts, save water, and receive instant notification of important system alarms.

User-Friendly

The addition of internet access brings dial-based Pro-C, ICC2, and ACC2 Controllers seamlessly into the world of next-generation irrigation control. From the intuitive Centralus dashboard, it's now easier than ever to add alarm monitoring, location information, remote operation, and scheduling to Pro-C, ICC2, and ACC2 Controllers.

Easy to Upgrade

To upgrade to Centralus control, add a simple Wi-Fi, Ethernet (LAN), or Cellular (LTE) communication module to the controller:

- Pro-C: PC-WIFI
- ICC2: WIFIKIT, LANKIT, or CELLKIT
- ACC2: A2C-WIFI, A2C-LAN, or A2C-LTEM



Centralus Software

Enable Pro-C, ICC2, and ACC2 Controllers with next-generation management technology. To learn more, visit centralus.hunterindustries.com.



PC-WIFI
Height: 4¼"
Width: 2¾"
Depth: ⅝"



WIFIKIT
Height: 4¼"
Width: 2½" (installed)
Depth: 1⅜"



LANKIT
Height: 4¼"
Width: 2½" (installed)
Depth: 1⅜"



CELLKIT
Height: 3⅝"
Width: 2⅝"
Depth: 1½"



A2C-WIFI
Height: 3"
Width: 2¼"
Depth: 1"



A2C-LAN
Height: 3"
Width: 2¼"
Depth: 1"



A2C-LTEM
Height: 3"
Width: 2¼"
Depth: 1"

ACC2

The multi-flow monitoring and management capabilities of the ACC2 Controller, combined with the option to upgrade to Centralus cloud-based control, make it the best choice for complex projects.

KEY BENEFITS

- Number of stations:
 - 12 to 225, for large projects
- Language-selectable, high-visibility display
- Up to 6 flow sensor inputs and 6 P/MV outputs
- 32 automatic programs (10 start times each) for precise plant management
- Block function to group stations and consolidate large systems
- Add a Solar Sync® Sensor to save water based on local weather conditions
- Real-time flow monitoring detects and diagnoses leaks in up to 6 flow zones
- Flow management optimizes watering at safe velocities
- High-visibility, full-color display with reversible facepack
- Conditional Response “if/then” programming for active responses to sensor inputs
- User management password protection, with two levels of access
- Optional plug-in communications modules for cloud or network control
- Detailed alarm logs
- Extreme service lightning protection
- Easy Retrieve® Memory programming backup and restore
- Non-Water Windows to inhibit accidental irrigation

OPERATING SPECIFICATIONS

- Transformer input: 120/230 VAC
- Maximum AC current draw: 120 VAC, 2 A/230 VAC, 1 A
- Transformer output: 24 VAC, ~3 A
- P/MV outputs (24 VAC): Up to 6; 3 included, 0.8 A each
- Sensor inputs: 3 Clik, 1 Solar Sync, and up to 6 Flow Sensors (3 included)
- Approvals: Wall Mounts IP55 (outdoor), Plastic Pedestal IP24 (outdoor), UL, cUL, FCC, CE, UKCA, RCM, ISED
- Warranty period: 5 years

USER-INSTALLED OPTIONS

- Centralus central control available with Wi-Fi, LAN (Ethernet), and cellular connection; **see page 133**
- SCADA/automation compatible with BACnet, Modbus, RESTful API, and other protocols via Hunter Field Servers; **see page 114**

View Centralus Software today,
at centralus.hunterindustries.com



Metal Wall Mount
(gray or stainless steel)
Height: 15¾"
Width: 15"
Depth: 6¾"



Plastic Wall Mount
Height: 16¾"
Width: 16½"
Depth: 6½"



Metal Pedestal
(gray or stainless steel)
Height: 37"
Width: 15½"
Depth: 5"



Plastic Pedestal
Height: 39½"
Width: 23½"
Depth: 17"

Compatible with:



Solar Sync Sensor
Page 140



Flow-Sync® Sensor
Page 145
Wireless Flow Sensor
Page 146



ROAM Remote
Page 130
ROAM XL Remote
Page 131



EPA WaterSense® Approved

Recognized as a responsible water-saving tool when used with a Solar Sync Sensor

ADDITIONAL SPECIFICATIONS BY MODEL

ACC2 CONVENTIONAL

- Number of stations:
 - 12 to 54, for large projects
- Simultaneous station operation: Up to 14 solenoids
- Expands in 6-station increments
- Extreme service lightning protection, standard on all A2M-600 Output Modules
- Station outputs: 0.8 A each

ACC2 CONVENTIONAL MODELS	
Model	Description
A2C-1200-M	12-station base unit controller, expands to 54 stations, gray steel wall mount, outdoor
A2C-1200-P	12-station base unit controller, expands to 54 stations, plastic outdoor wall mount
A2C-1200-SS	12-station base unit controller, expands to 54 stations, stainless steel wall mount, outdoor
A2C-1200-PP	12-station base unit controller, expands to 54 stations, plastic pedestal
A2M-600	6-station plug-in module for use with the A2C-1200 series controllers

ACC2 DECODER

- Number of stations:
 - 75, 150, or 225, for large projects
- Simultaneous station operation: Up to 30 solenoids
- Operates Hunter's premium ICD Decoders over ID wire:
 - Up to 10,000' (14 AWG wire)
 - Up to 15,000' (12 AWG wire)
- See complete ICD Decoder key benefits and specifications on [page 124](#)
- Up to 3 two-wire paths per output module
- Diagnostics including decoder inventory, wire tracker, solenoid finder, and more

ACC2 DECODER MODELS	
Model	Description
A2C-75D-M	75-station base model, gray metal outdoor, wall mount
A2C-75D-P	75-station base model, plastic outdoor, wall mount
A2C-75D-SS	75-station base model, stainless steel, wall mount
A2C-75D-PP	75-station base model, plastic pedestal
A2C-D75	75-station decoder expansion module

ACC2 ACCESSORIES FOR ALL MODELS

ACC2 ACCESSORIES	
Model	Description
A2C-F3	Optional flow meter expansion module (adds 3 inputs)
A2C-LEDKT	External status light shows controller status with door closed
A2C-WIFI	ACC2 Wi-Fi connection
A2C-LAN	ACC2 LAN (Ethernet) connection
A2C-LTEM	Cellular Communication Module (4G LTE) for ACC2 Controllers (monthly service plan required)
ACC-PED	Gray pedestal for wall mount
PED-SS	Stainless steel pedestal for wall mount

ACC2 REVERSIBLE FACEPACK AND AUTOMATIC DIAGNOSTIC MODE



ICC2

This flexible control system can run any combination of conventional, EZDS two-wire, or Wireless Valve Link outputs with the option to upgrade to cloud-based Centralus™ control.

KEY BENEFITS

- Number of stations:
 - Conventional: 8 to 38 (plastic), 8 to 54 (metal and pedestals)
 - With two-wire EZDS: up to 54 (all enclosure options)
 - With Wireless Valve Link (WVL): up to 54 (all enclosure options)
- 4 automatic irrigation programs with 8 start times per program and 12-hour run times per station
- Any 2 programs can operate simultaneously, providing more efficient watering
- 1 sensor input available for use with Solar Sync® or any Clik Sensors
- 1 flow sensor input available with Centralus communication modules
- 1 P/MV output for pump start relay and master valve activation
- Backward compatibility to original ICC Controllers allows for quick updates to older systems
- Upgradable to Centralus Software for web-based central control options

OPERATING SPECIFICATIONS

- Transformer input: 120/230 VAC
- Transformer output (24 VAC): 1.4 A
- Station output (24 VAC): 0.56 A
- P/MV output (24 VAC): 0.56 A
- Approvals: Wall Mounts IP55 (outdoor), Plastic Pedestal IP24 (outdoor), UL, cUL, FCC, CE, UKCA, RCM, ISED
- Warranty period: 5 years

USER-INSTALLED OPTIONS

- WIFIKIT, LANKIT, or CELLKIT communications for cloud-based Centralus control
- Compatible with Hunter Flow-Sync® Sensor and HC Flow Meter for flow monitoring and high-flow shutdown capabilities via Centralus Software
- SCADA/automation compatible with BACnet, Modbus, and other protocols via Hunter Field Servers; **see page 114**
- Compatible with ROAM and ROAM XL Remotes; **see pages 130 and 131**

ICC2	
Model	Description
I2C-800-PL	8-station base model, plastic outdoor wall mount
I2C-800-M	8-station base model, gray metal outdoor, wall mount
I2C-800-SS	8-station base model, stainless steel, wall mount
I2C-800-PP	8-station base model, plastic pedestal
ICC-FPUP2	ICC2 Retrofit Kit for original ICC Controllers
ICC-PED	Gray pedestal for metal controller mount
ICC-PED-SS	Stainless steel pedestal for stainless steel controller mount
ICC-PWB	Optional pedestal wiring board for metal pedestals

ICC2 SERIES STATION EXPANSION	
Model	Description
ICM-400	4-station plug-in module with enhanced surge suppression
ICM-800	8-station plug-in module with enhanced surge suppression
ICM-2200	22-station expansion module (one per controller)
EZDS	See page 126 for model chart
WVL	See page 122 for model chart

View Centralus Software today, at centralus.hunterindustries.com



Plastic
Height: 12"
Width: 13¾"
Depth: 5"

Metal
(gray or stainless steel)
Height: 16"
Width: 13"
Depth: 5"



Metal Pedestal
(gray or stainless steel)
Height: 36"
Width: 11½"
Depth: 5"



Plastic Pedestal
Height: 39"
Width: 24"
Depth: 17"

Compatible with:



**Solar Sync
Sensor**
Page 140



**WVL Wireless
Valve Link**
Page 122

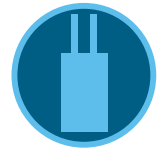

**EZ Decoder
System**
Page 126



EPA WaterSense

Recognized as a responsible water-saving tool when used with a Solar Sync Sensor

PRO-C®

Simple programming and flexible station expansion make the Pro-C Controller the professional's choice for residential and light commercial systems.

KEY BENEFITS

- Number of stations:
 - Modular Pro-C
 - Conventional wiring from 4 to 23 stations
 - Hybrid EZ Decoder option up to 32 total stations (28 stations maximum if two-wire only)
- 3 automatic irrigation programs with 4 start times per program and 6-hour run times per station
- 2 sensor inputs available for use with Solar Sync® or any Clik Sensors
- 1 P/MV output for pump start relay and master valve activation
- 1 flow sensor input available with Centralus Wi-Fi module
- High-visibility, backlit display for simple programming in any light
- Optional Seconds Mode allows for station run times with seconds resolution from 1 second to 5 minutes
- Easy Retrieve® Memory allows for manual backup and retrieval of preferred settings and programming
- QuickCheck™ Technology provides simple diagnostics of faulty field wiring
- Backward compatible with previous modular PC-400 models dated 2014 to 2023

OPERATING SPECIFICATIONS

- Transformer input: 120 VAC
- Transformer output (24 VAC): 1 A
- Station output (24 VAC): 0.56 A
- P/MV output (24 VAC): 0.28 A
- Approvals: IP44 (outdoor), UL, cUL, FCC, CE, UKCA, RCM, ISED
- Warranty period: 2 years

USER-INSTALLED OPTIONS

- PC-WIFI communication module for cloud-based Centralus control
- Compatible with Hunter Flow-Sync® Sensor and HC Flow Meter for flow monitoring and high-flow shutdown capabilities via Centralus Software



Plastic Outdoor

Height: 9"
Width: 10"
Depth: 4½"

P2C-400 CONTROLLER WITH 2 SENSOR INPUTS



CENTRALUS CONTROLLERS

Compatible with:



**Solar Sync
Sensor**
Page 140



ROAM Remote
Page 130
ROAM XL Remote
Page 131

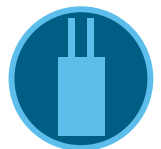

**EZ Decoder
System**
Page 126

PRO-C	
Model	Description
P2C-400	4-station base, plastic wall mount cabinet with cable and plug

PC-SERIES STATION EXPANSION	
Model	Description
PCM-300	3-station plug-in module
PCM-900	9-station plug-in module
PCM-1600	16-station plug-in module
PC-DM	EZ Decoder Output Module



EPA WaterSense

Recognized as a responsible water-saving tool when used with a Solar Sync Sensor

HUNTER FIELD SERVERS

These high-performance devices make it easy to communicate directly with Hunter ACC2 and ICC2 Controllers from centralized command centers.

KEY BENEFITS

- Field server for BACnet, Modbus, RESTful API, and over 120 other automation protocols
- Up to 3,000 data points with complete documentation and demo software with Hunter license agreement
- Integrates controllers directly into SCADA, Smart City, and BMS applications
- Allows total access to all controller commands, reports, and features from the customer's integration software
- Does not require internet connection or other proprietary control software
- 2 x RJ-45 receptacles for system and controller connections
- 1 x RS-485/RS-232 and 1 x RS-485
- DIN rail mounting included
- Made in USA

OPERATING SPECIFICATIONS

- Serial (galvanic isolation): 1 x RS-485/RS-232 and 1 x RS-485
- Baud: 9600, 19200, 38400, 57600, 76800, 115000
- Ethernet: 2 x 10/100BaseT, MDIX, DHCP
- Operating temperature: -4°F to 158°F (-20°C to 70°C)
- Relative humidity: 10% to 95% RH non-condensing



Hunter Field Server

Height: 4"
Width: 1 $\frac{1}{4}$ "
Depth: 2 $\frac{7}{16}$ "



Field Server Connections

HUNTER FIELD SERVER MODEL CHART

Model	Description
FS-3000	Field Server, 3,000 data points
FS-1000	Field Server, 1,000 data points

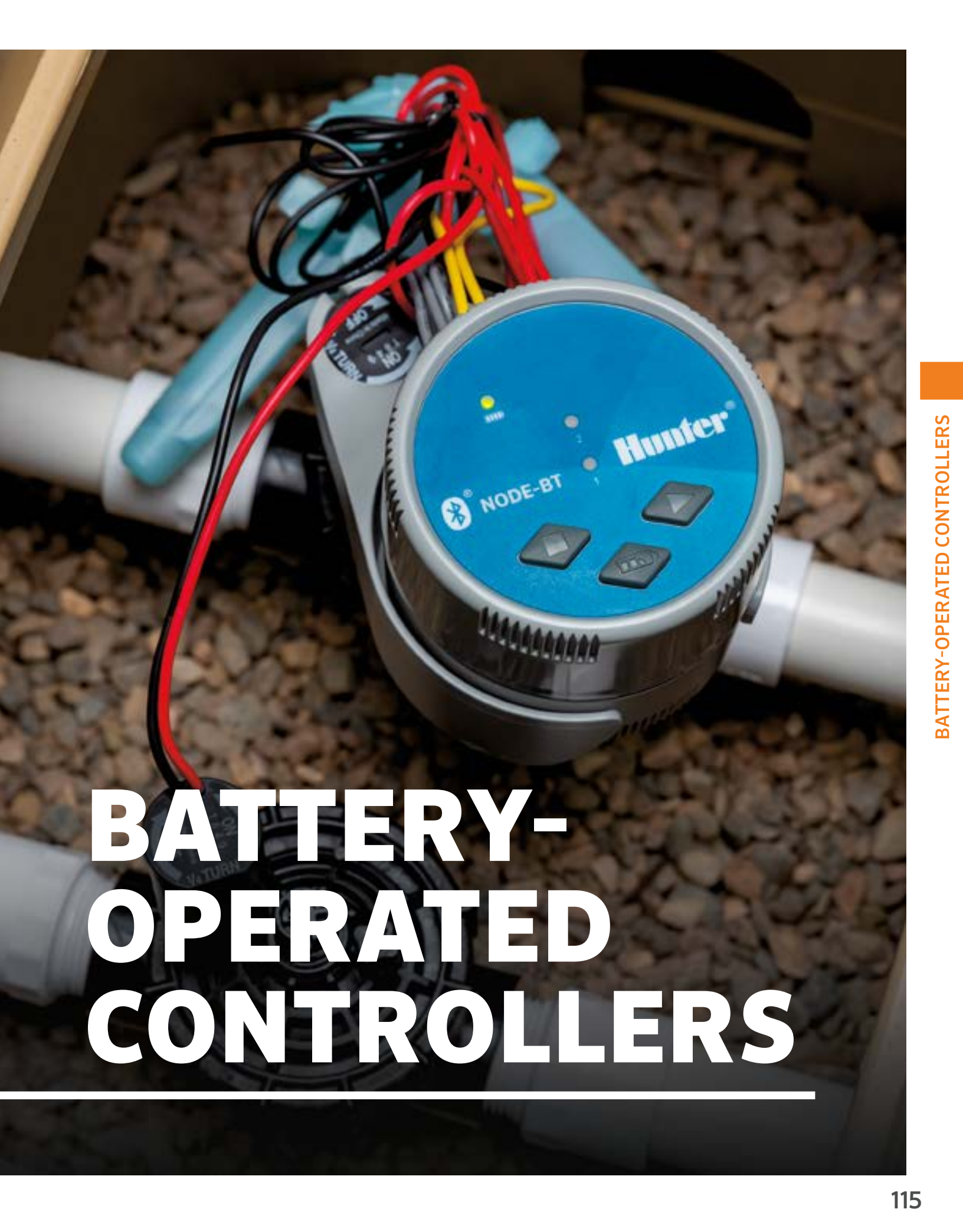

BATTERY-OPERATED CONTROLLERS



When locations are difficult to access, lack electrical power, or demand cost-prohibitive wire runs, battery-operated controllers can make irrigation effective and affordable. Unlike traditional irrigation systems, they save time and money because there's no need to run wire, obtain construction permits, or lease equipment to tunnel under concrete or other hardscape elements. Since these systems are less intrusive, they can also help you win bids where specifications are strict about AC power requirements.

BATTERY-OPERATED CONTROLLER COMPARISON CHART

CONTROLLER MODELS	MAXIMUM STATIONS	SENSOR INPUTS	REMOTE CONTROL	SOLAR
BTT	2	N/A	BTT Bluetooth® App	N/A
NODE	6	1	N/A	SPNODE
NODE-BT	4	2	NODE-BT Bluetooth App	SPNODEBT
XC Hybrid	12	1	N/A	SPXCH, XCH-600-SSP, XCH-1200-SSP

BTT

Take advantage of smartphone-controlled, above-ground irrigation for easier access to the hose tap.

KEY BENEFITS

- Number of zones:
 - 1 or 2 (fixed models)
- Battery-operated tap timer with Bluetooth® control
- 1 smartphone manages an unlimited number of controllers
- 1-second to 24-hour run time with multiple start times for maximum programming flexibility
- Cycling mode repeats continuously within user-defined water windows, perfect for drip systems or germinating seeds
- Suspend irrigation up to 99 days during the off-season, ideal for seasonal markets
- Manual push-button operation for quick operation without a smartphone
- Automatic water shutoff after 1 hour prevents water waste
- Blinking LED low-battery alert indicates battery replacement
- Alkaline batteries included for quicker installation

OPERATING SPECIFICATIONS

- Two 1.5V AA alkaline batteries (included)
- Flow rate: 0.5 to 600 GPH
- Recommended pressure: 7 to 116 PSI
- See friction loss chart on [page 206](#)
- Bluetooth 4.0/4.2 (BLE)
- Approvals: Plastic IPX6 (outdoor), UL, cUL, FCC, CE, UKCA, RCM, ISED
- Warranty period: 2 years

APP SPECIFICATIONS

- iOS® 9.0 or above, Android™ 4.4 or above
- Maximum communication distance: 32'
- See all app features at hunter.info/BTT



BTT-100
Inlet diameter: 3/4"
Outlet diameter: 3/4"
Height: 5"
Width: 5"
Depth: 2 1/2"



BTT-200
Inlet diameter: 3/4"
Outlet diameter: 3/4"
Height: 6 1/4"
Width: 5 1/4"
Depth: 3"



BTT-LOC
(optional)
Inlet diameter: 3/4"
Outlet diameter: 16-18 mm dripline
Height: 2 3/4"
Width: 1 1/4"



Pressure Regulator
(optional)
Inlet diameter: 3/4"
Outlet diameter: 3/4"
Height: 3"
Width: 1 1/2"

BTT	
Model	Description
BTT-100	1-zone Bluetooth Tap Timer, 3/4" hose thread
BTT-200	2-zone Bluetooth Tap Timer, 3/4" hose thread

USER-INSTALLED OPTIONS	
Model	Description
BTT-LOC	BTT adapter for 16-18 mm dripline
PRLG203FH3MH	20 PSI pressure regulator, 3/4" hose thread
PRLG253FH3MH	25 PSI pressure regulator, 3/4" hose thread
PRLG303FH3MH	30 PSI pressure regulator, 3/4" hose thread
PRLG403FH3MH	40 PSI pressure regulator, 3/4" hose thread

The Bluetooth® word mark and logos are registered trademarks owned by Bluetooth SIG Inc. and any use of such marks by Hunter Industries is under license. iOS is a trademark or registered trademark of Cisco in the U.S. and other countries and is used under license. Android is a trademark of Google LLC.

BTT WITH HUNTER DRIPLINE (HDL) INSTALLATION



To control drip irrigation applications with BTT, use the BTT-LOC Drip Adapter, which connects BTT to HDL surface and subsurface systems.

Compatible with:

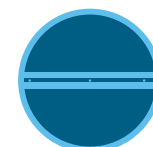

HDL Dripline
Page 160

NODE

This battery-operated, waterproof controller offers automatic irrigation control for temporary irrigation and sites without electricity.

KEY BENEFITS

- Number of stations:
 - 1, 2, 4, or 6 (fixed models)
- Battery-operated controller for automatic irrigation
- Battery-life indicator for battery replacement
- Waterproof enclosure seal protects against water ingress
- 3 flexible programs with 4 start times each and up to 6-hour run times
- Suspend irrigation up to 99 days during the off-season
- Easy Retrieve® Memory backs up the full irrigation schedule if ever changed
- Seasonal adjustment for quicker schedule adjustments without changing run times
- Solar panel provides maintenance-free operation
- Mounts to Hunter solenoids, pipes, flat surfaces, or inside the valve box

OPERATING SPECIFICATIONS

- One or two 9V alkaline batteries or 800 mAh solar panel with charging cell
- Operates Hunter DC-Latching Solenoids; **see page 88**
- 100' maximum wire runs, 18 AWG wire only
- Solar panel includes 40' of direct-burial wire
- Station output: 9-11 VDC
- P/MV output: 9-11 VDC (multi-station models)
- Sensor inputs: 1 (wired rain, freeze, or wind only)
- Approvals: IP68 (submersible), UL, cUL, FCC, CE, UKCA, RCM, ISED
- Warranty period: 2 years



NODE
Height: 2½"
Diameter: 3½"



SPNODE
Solar Panel Kit (optional)
Height: 3¼"
Length: 3"
Width: 5⁄8"
Controller to solar panel: 100' maximum
18 AWG direct-burial wire

NODE WITH PGV INSTALLATION



Compatible with:



**Mini-Click®
Sensor**
Page 139



**Waterproof Wire
Connector**
Page 129

NODE

Model	Description
NODE-100	Single-station battery controller and DC-Latching Solenoid
NODE-100-LS	Single-station battery controller
NODE-100-VALVE	Single-station battery controller with PGV-101G valve and DC-Latching Solenoid (NPT threads)
NODE-200	2-station battery controller
NODE-400	4-station battery controller
NODE-600	6-station battery controller

USER-INSTALLED OPTIONS

Model	Description
SPNODE	Solar Panel Kit for NODE controllers
458200	DC-Latching Solenoid (for all Hunter valves)

NODE-BT

Manage gardens, greenhouses, traffic medians, and temporary irrigation sites from a smartphone without opening the valve box.

KEY BENEFITS

- Number of stations:
 - 1, 2, or 4 (fixed models)
- Bluetooth® battery-operated controller for automatic irrigation
- Active station LEDs and battery-life LED indicator for replacement
- 3 programs with 8 start times each and 1 second to 12-hour run times
- Suspend irrigation up to 99 days during the off-season
- Manual push-button operation for quick operation without a smartphone
- Delay Between Stations for slow-closing valves or pump recharge
- Cycle and Soak prevents water waste and runoff in areas with elevation changes or tight soils
- Monthly and global seasonal adjustment for quicker schedule adjustments without changing run times

OPERATING SPECIFICATIONS

- One or two 9 V alkaline batteries
- Operates Hunter DC-Latching Solenoids; **see page 88**
- 100' maximum wire runs, 18 AWG wire only
- Station output: 9 to 11 VDC
- P/MV output: 9 to 11 VDC (multi-station models)
- Sensor inputs: 2 (wired soil plus wired rain, freeze, or wind only)
- Bluetooth 5.0 (BLE)
- Approvals: IP68 (submersible), UL, cUL, FCC, CE, UKCA, RCM, ISED
- Warranty period: 2 years

APP SPECIFICATIONS

- iOS® 9.0 or above, Android™ 5.0 or above
- Maximum communication distance: 50'
- See all app features at hunter.info/NodeBT

NODE-BT	
Model	Description
NODE-BT-100	Single-station Bluetooth battery controller and DC-Latching Solenoid
NODE-BT-100-LS	Single-station Bluetooth battery controller
NODE-BT-100-VALVE	Single-station Bluetooth battery controller with PGV-101G valve and DC-Latching Solenoid (NPT threads)
NODE-BT-200	2-station Bluetooth battery controller
NODE-BT-400	4-station Bluetooth battery controller

USER-INSTALLED OPTIONS	
Model	Description
SC-PROBE	Soil probe for moisture sensing
SP-NODEBT	Solar Panel Kit for NODE-BT Controllers
458200	DC-Latching Solenoid (for all Hunter valves)

The Bluetooth® word mark and logos are registered trademarks owned by Bluetooth SIG Inc., and any use of such marks by Hunter Industries is under license. iOS is a trademark or registered trademark of Cisco in the U.S. and other countries, and is used under license. Android is a trademark of Google LLC.



NODE-BT
Height: 3"
Diameter: 3½"



SC-PROBE
Soil Moisture Sensor (optional)
Height: 3¼"
Diameter: 1"



SP-NODEBT
NODE-BT Solar Panel
Height: 1¾"
Width: 3"
Depth: 9½"

NODE-BT WITH PGV INSTALLATION



Compatible with:

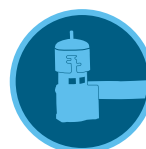

Mini-Clik Sensor
Page 139



Waterproof Wire Connector
Page 129

XC HYBRID

Effectively manage landscapes where electricity is unavailable with this economical battery-operated or solar-powered controller.

KEY BENEFITS

- Number of stations:
 - 6 or 12 (fixed models)
- 3 power options: ambient-light-compatible solar panel, battery, or AC power
- Stainless steel enclosure protects against vandalism
- 3 programs with 4 start times each and up to 4-hour run times
- Easy Retrieve® Memory backs up the full irrigation schedule
- Delay Between Stations for slow-closing valves or pump recharge
- Seasonal adjustment for quicker schedule adjustments without changing run times
- Solar Panel provides maintenance-free operation
- Mounts to flat surfaces or steel posts

OPERATING SPECIFICATIONS

- Plastic model operates six 1.5 V AA alkaline batteries
- Stainless steel model operated by six 1.5 V C alkaline batteries
- Stainless steel solar model operates 800 mAh solar panel with charging cell
- Solar panel includes 40' of direct-burial wire
- Controller to solar panel: 100' maximum 18 AWG direct-burial wire
- All models operate optional 120/24 VAC plug-in wall adapter (P/N 526500)
- Operates Hunter DC-Latching Solenoids; **see page 88**
- Station output: 9 to 11 VDC
- P/MV output: 9 to 11 VDC
- Sensor inputs: 1 (wired rain, freeze, or wind only)
- Approvals: Plastic IP54 (outdoor), Stainless Steel IP24 (outdoor), UL, cUL, FCC, CE, UKCA, RCM, ISED
- Warranty period: 2 years



Plastic
Height: 8 $\frac{5}{8}$ "
Width: 7"
Depth: 3 $\frac{3}{4}$ "



Stainless Steel
Height: 9 $\frac{3}{4}$ "
Width: 7 $\frac{3}{8}$ "
Depth: 4 $\frac{1}{4}$ "



Stainless Steel Solar
Height: 10 $\frac{3}{4}$ "
Width: 7 $\frac{3}{8}$ "
Depth: 4 $\frac{1}{4}$ "



SPXCH
Solar panel kit (optional)
Height: 5 $\frac{1}{2}$ "
Length: 3"
Width: 3"



XCHSPB
Mounting bracket and hardware only (optional)



XCHSPOLE
Pole-Mounting Kit (optional)
Height: 4'

Compatible with:

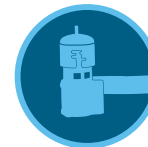

Mini-Click Sensor
Page 139

MAXIMUM WIRE RUNS

Wire Size	Max. Distance
18 AWG	550'
16 AWG	870'
14 AWG	1,380'
12 AWG	2,200'

XC HYBRID	
Model	Description
XCH-600	6-station battery controller
XCH-600-SS	6-station battery controller, stainless steel
XCH-600-SSP	6-station controller, stainless steel, with mounted solar panel
XCH-1200	12-station battery controller
XCH-1200-SS	12-station battery controller, stainless steel
XCH-1200-SSP	12-station controller, stainless steel, with mounted solar panel

USER-INSTALLED OPTIONS	
Model	Description
DCREL2	Latching sensor relay switch for pumps
526500	120/24 VAC plug-in wall adapter
458200	DC-Latching Solenoid (for all Hunter Valves)



CONTROLLER DECODERS & ACCESSORIES



WIRELESS VALVE LINK

Enable convenient wireless valve control for ICC2 and HCC Controllers with the highly flexible and easy-to-install Wireless Valve Link.

KEY BENEFITS

- Works with Hunter ICC2 and HCC Controllers, compatible with Centralus™ and Hydrowise® Irrigation Management Platforms
- Add up to 54 valves plus P/MV up to 2,000' line of sight*
- License-free LoRa® wireless connections direct to valve box — no copper field wiring required
- Wireless Solar Repeater (RPT) can extend or double ranges
- Seamless system expansion enables connection across hardscapes and other obstacles without wiring
- Combine with conventional ICM or EZDS Modules as needed (54 stations plus P/MV maximum per controller)
- Isolation from lightning or surge events in the field
- No field wires, wire breaks, or tracking
- No cutting into hardscape, plowing, boring, or lightning surge back to the controller

OPERATING SPECIFICATIONS

- Low-profile, waterproof valve box lid mount for field durability
 - Requires 1½" diameter hole in valve box lid (hole saw supplied with WVOM)
- Two-way communications confirm field performance
- LoRa radio: 900 MHz for North America
- 1-, 2-, and 4-station configurations to optimize field installations
- Operates Hunter DC-Latching Solenoids; **see page 88**
- Maximum distance from WVL to solenoid: 100' with 18 AWG wire
- One or two 9 VDC batteries per WVL
 - Replace batteries once per season or year
 - Solar recharging option with SP-WVL
- Built-in site survey and manual test functions
- Easy, free setup with iOS® 9.0 or above, Android™ 5.0 or above, and Bluetooth® apps
- Approvals:
 - WVOM: UL, cUL, FCC, CE, UKCA, RCM, ISED
 - WVL in-box control links: IP68 (submersible)
 - RPT Wireless Solar Repeater (universal mount included): IP55 (outdoor)
- Warranty period: 2 years

* Wireless range is subject to terrain, foliage, buildings, and other site factors. Consult product documentation before installing.

Compatible with:



**Hydrowise
Software**
Page 98



**Centralus
Software**
Page 108



ROAM Remote
Page 130
ROAM XL Remote
Page 131



Wireless Valve Output Module (WVOM)

Height: 4½"
Width: 3¾"
Length: 1½"



Wireless Valve Link (WVL-XXX)

See model chart on next page.
Diameter: 4¼"
Height: 6½"



Wireless Solar Repeater (RPT)

Height: 13¾" (installed with antenna extended)
Width: 6¾"
Length: 7¾"



SP-WVL

Solar Panel
Height: 1¾"
Width: 3"
Depth: 9½"

The LoRa® Mark is a trademark of Semtech Corporation or its subsidiaries. The Bluetooth word mark and logos are registered trademarks owned by Bluetooth SIG Inc., and any use of such marks by Hunter Industries is under license. iOS is a trademark or registered trademark of Cisco in the U.S. and other countries and is used under license. Android is a trademark of Google LLC.

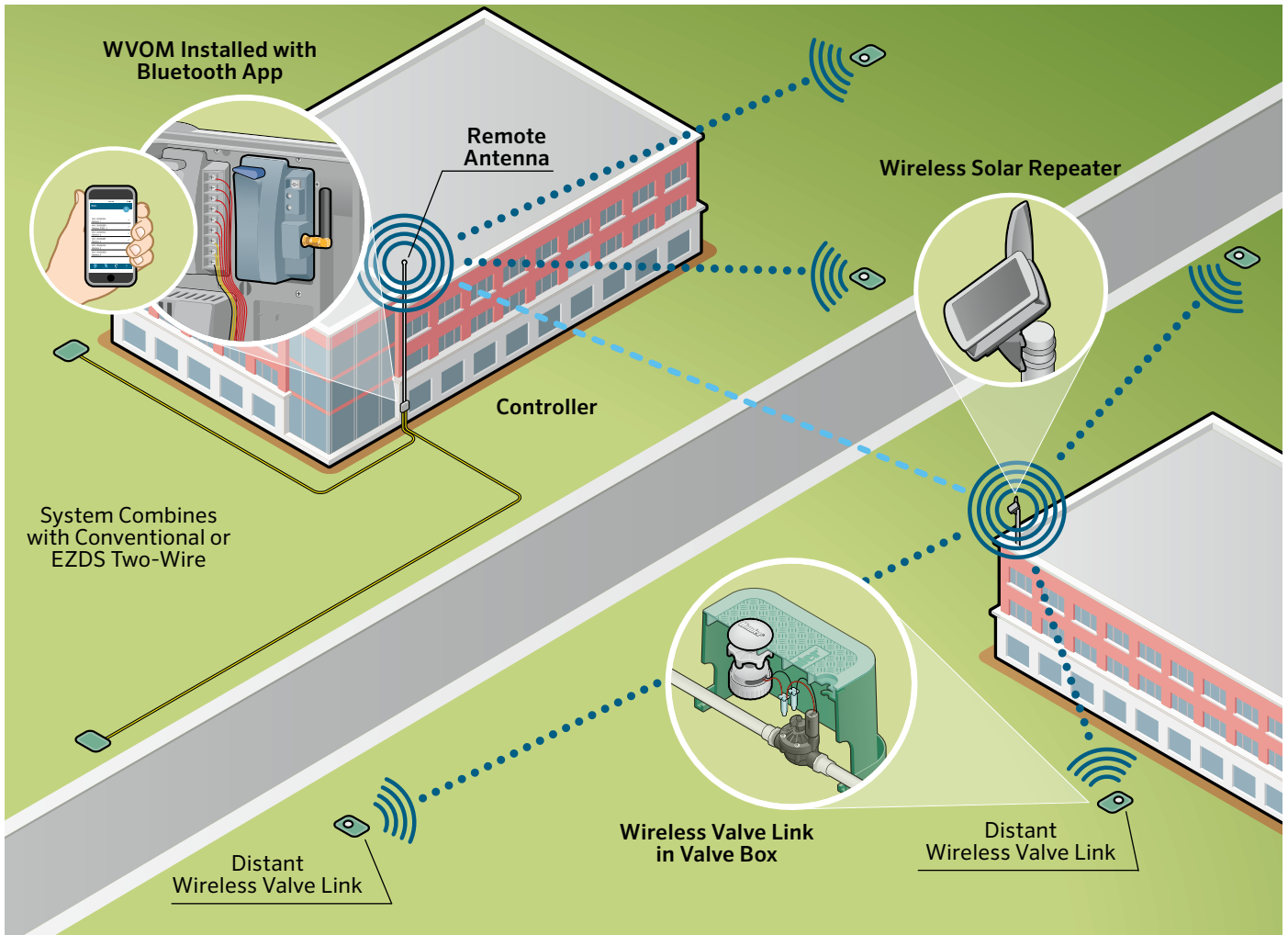

WIRELESS VALVE LINK MODEL CHART

Model	Description
WVOM	Wireless Valve Output Module for ICC2/HCC Controllers
WVL-100	Single-station Wireless Valve Link (antenna included)
WVL-200	2-station Wireless Valve Link (antenna included)
WVL-400	4-station Wireless Valve Link (antenna included)
RPT	Battery-operated Wireless Solar Repeater for WVL range extension (1 per system, max)

USER-INSTALLED OPTIONS

Model	Description
ANT-EXT-KIT	Universal Antenna Extension Kit
458200	Hunter DC-Latching Solenoids (for all Hunter valves)
SP-WVL	Solar Panel Kit for WVL Controllers

WIRELESS VALVE LINK INSTALLED IN VALVE BOX



ICD

Hunter's premium two-wire decoders for long-distance, high-station-count ACC2 applications include two-way communications and integrated surge protection.

KEY BENEFITS

- ICD Decoders are compatible with ACC2 Decoder Controllers and legacy ACC-99D Decoder Controllers
- 1-, 2-, 4-, and 6-station versions provide maximum flexibility
- Sensor decoders allow Flow and Klik Sensor monitoring via the two-wire paths
- Field-programmable decoders accept station numbers directly, and do not require entering serial numbers into the control panel
 - Decoders can be programmed before installation at the controller interface
 - Use of ICD-HP Programmer allows for wireless decoder programming or reprogramming after installation to the two-wire path
- Integrated surge protection eliminates the need for extra surge protection devices
- Color-coded wiring connections simplify installation
- Industrial-grade, waterproof DRBY Splice Connectors included for two-wire path splices

OPERATING SPECIFICATIONS

- Maximum recommended distance, decoder to solenoid: 150'
- Maximum distance to decoder via two-wire path:
 - 14 AWG wire path: 10,000'
 - 12 AWG wire path: 15,000'
- Approvals: UL, cUL, FCC, CE, UKCA, RCM
- Decoder rating: IP68 (submersible)
- Warranty period: 5 years

USER-INSTALLED OPTIONS

- Wireless handheld ICD-HP Programmer; **see page 125**
- DECSTAKE10 Universal Decoder Stake, 10-pack; **see page 128**



ICD-100, 200, ICD-SEN

Height: 3½"
Width: 1½"
Depth: ¾"

ICD-400, 600

Height: 3½"
Width: 1¾"
Depth: 1½"

DECODER MODELS

Model	Description
ICD-100	Single-station decoder with surge suppression and ground wire
ICD-200	2-station decoder with surge suppression and ground wire
ICD-400	4-station decoder with surge suppression and ground wire
ICD-600	6-station decoder with surge suppression and ground wire
ICD-SEN	2-input sensor decoder with surge suppression and ground wire

ID WIRE MODEL GUIDE

14 AWG Decoder Cable		12 AWG Long-Range, Heavy-Duty Decoder Cable	
ID1GRY	Gray jacket	ID2GRY	Gray jacket
ID1PUR	Purple jacket	ID2PUR	Purple jacket
ID1YLW	Yellow jacket	ID2YLW	Yellow jacket
ID1ORG	Orange jacket	ID2ORG	Orange jacket
ID1BLU	Blue jacket	ID2BLU	Blue jacket
ID1TAN	Tan jacket	ID2TAN	Tan jacket

ID WIRE MAXIMUM WIRE RUNS

ID 1 Wire	ID 2 Wire
5,000' with legacy DUAL systems	7,500' with legacy DUAL systems
10,000' with ICD systems	15,000' with ICD systems

Compatible with:



Waterproof Splice Kit
Page 129

ICD-HP PROGRAMMER

Gain wireless, handheld programming and diagnostic capabilities for Hunter ICD and legacy DUAL® Decoders.

KEY BENEFITS

- Program or re-program decoder stations, whether new or installed*
 - Simplifies setup and diagnostics for sensor decoders
 - Sensor test functions for Flow and Klik Sensors, plus built-in multimeter
 - Communicates with decoder through plastic case: wireless electromagnetic induction saves waterproof connectors
 - Compatible with Hunter ICD and legacy DUAL Decoders, as well as Pilot® Two-Way Modules
 - USB-powered for shop or office use; 4 AA batteries for field use
 - All test leads and cables included in durable, foam-padded carrying case
 - Turn decoder stations on and view solenoid status, current in milliamps, and more
 - Waterproof programming cup
 - Backlit adjustable display
 - 6 operating languages
- * **Note:** ICD-HP Programmer is not compatible with EZ-1 Decoders

ELECTRICAL SPECIFICATIONS

- Power input: 4 AA batteries, or standard USB connector (included)
- Communications: wireless induction, range 1"
- Fused test leads for unpowered decoder functions

APPROVALS

- UL, cUL, FCC, CE, UKCA, RCM



ICD-HP

Height: 8¼"
Width: 3⅞"
Depth: 2"

Packaged in an outdoor carrying case, this complete kit includes probes, induction cup, cable, USB power cable for bench use, and 4 AA batteries for fieldwork.

ICD-HP



ICD-HP	
Model	Description
ICD-HP	Wireless handheld decoder programmer, includes all test and power leads, programming cup, and rugged carrying case

EZ DECODER SYSTEM

Bring two-wire technology to more projects than ever before with the revolutionary, low-cost, and hassle-free EZ Decoder System for Pro-C®, HPC, ICC2, and HCC Controllers.

KEY BENEFITS

- Number of stations:
 - Pro-C/HPC Controllers: Up to 28, plus master valve
 - ICC2/HCC Controllers: Up to 54, plus master valve
- No special wire or connectors required
- No special grounding or surge arrestors required in-line to maximize time and money savings during installation
- Programmable decoders with no need to input individual serial numbers
- P/MV can activate via the two-wire path for distant master valves
- Permits hybrid operations of side-by-side conventional and decoder stations for added flexibility
- EZ-1 Decoders have built-in status LED for positive diagnostics

OPERATING SPECIFICATIONS

- Electrical output on two-wire path: 24 VAC, 50/60 Hz
- Two-wire paths to the field:
 - EZ-DM: 2
 - PC-DM: 1
- Wire paths possible over 3,000' (see Wiring Table below)
- Each EZ-1 Decoder can activate two standard 24 VAC solenoids
- Operate any two decoders simultaneously for more efficient watering (ICC2 and HCC Controllers only)
- Approvals: UL, cUL, FCC, CE, UKCA, RCM, ISED
- EZ-1 Decoders are IP68 rated (submersible)
- Warranty period: 3 years

USER-INSTALLED OPTIONS

- Centralus™ Software with Pro-C and ICC2 Controllers
- Hydrowise® Software with HPC and HCC Controllers
- Compatible with Waterproof Wire Connector; [see page 129](#)
- EZ-DT Diagnostic Tool for wireless diagnostics with EZ-1 Decoders; [see page 127](#)
- DECSTAKE10 Universal Decoder Stake, 10-pack; [see page 128](#)



Single-Station Decoder

Height: 27/8"
Width: 15/8"
Depth: 5/8"



Decoder Output Module: EZ-DM

Height: 41/2"
Width: 21/2"
Depth: 15/8"



Decoder Output Module: PC-DM

Height: 3"
Width: 3"
Depth: 11/4"

Compatible with:



HCC Controller
[Page 104](#)



ICC2 Controller
[Page 112](#)



Pro-C Controller
[Page 113](#)

WIRING TABLE

American Wire Gauge	Distance, single solenoid	Distance, 2 solenoids per output
18 AWG	908'	454'
16 AWG	1,446'	723'
14 AWG	2,292'	1,146'
12 AWG	3,650'	1,825'

Note

Distances in the Wiring Table are calculated based on 60 Hz for American Wire Gauge with a wire temperature of 120°F and a 10% safety factor.

DECODER MODELS

Model	Description
EZ-DM	Decoder output module for HCC and ICC2 Controllers
PC-DM	Decoder output module for HPC and Pro-C Controllers
EZ-1	Single-station decoder with status LED
EZ-DT	EZ-DT Diagnostic Tool

EZ-DT

Simplify maintenance of EZ Decoder Systems with the handheld, wireless EZ-DT Diagnostic Tool.

KEY BENEFITS

- Wireless, handheld diagnostic tool for EZ-1 Decoders
- Detect faults and perform electrical troubleshooting in the field without uninstalling decoders
- Quickly read decoder status, station address, current draw, and two-wire voltage to simplify maintenance
- Program decoder station address via wired connection to speed up installation and save time on-site
- Update controller facepack or decoder module firmware via ribbon cable connection for flexibility when updating systems
- Communicate in your preferred language using the multilingual user interface
- Work reliably and efficiently on the go with power supplied by 4 AAA batteries

OPERATING SPECIFICATIONS

- Power input: 4 AAA batteries (included)
- Communications: Wireless induction, 1" range from decoder to EZ-DT Diagnostic Tool
- 1.8" full-color, backlit TFT display

USER-INSTALLED OPTIONS

- Centralus™ Software with Pro-C and ICC2 Controllers
- Hydrowise® Software with HPC and HCC Controllers
- DECSTAKE10 Universal Decoder Stake, 10-pack; [see page 128](#)



EZ-DT Diagnostic Tool

Height: 7¾"
Width: 2¼"
Depth: ¾"

EZ-DT DIAGNOSTIC TOOL



DECODER MODELS	
Model	Description
EZ-DM	Decoder output module for HCC and ICC2 Controllers
PC-DM	Decoder output module for HPC and Pro-C Controllers
EZ-1	Single-station decoder with status LED
EZ-DT	EZ-DT Diagnostic Tool

Compatible with:



HCC Controller
Page 104



ICC2 Controller
Page 112

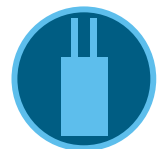

EZ Decoder System
Page 126

UNIVERSAL DECODER STAKE

The Universal Decoder Stake raises the decoder off the ground to keep two-wire installations organized, clean, and easily accessible during routine maintenance.

KEY BENEFITS

- Raises decoder off the ground, so contractors don't have to dig the device out of the mud
- Holds Hunter decoders in end-up position for convenient access and wireless programming without removal
- Works with all Hunter decoders and most other brands, so contractors only need to stock one item
- Zip ties conveniently included to secure the stake during installation
- Sturdy construction ensures the stake won't break or bend when hammered into the dirt
- Made primarily from recycled materials with minimal packaging to prevent waste and minimize carbon footprint

OPERATING SPECIFICATIONS

- Fits all Hunter decoders and most other brands
- Zip ties included
- Made of recycled materials

UNIVERSAL DECODER STAKE

Model	Description
DECSTAKE10	Universal Decoder Stake (10 per carton), zip ties included

Universal Decoder Stake

Height: 10 $\frac{3}{4}$ "



UNIVERSAL DECODER STAKE



ANTENNA EXTENSION KITS

Use these flexible Antenna Extension Kits when buildings, terrain, or other obstructions prevent reliable wireless communications.

KEY BENEFITS

- Universal Antenna Extension Kit option for Wi-Fi, cellular, and LoRa® radio communications (ANT-EXT-KIT)
 - Wi-Fi: HCC Controller, A2C-WIFI
 - Cell: A2C-LTEM
 - LoRa: WVOM
- For ROAM XL Remotes, extend the receiver antenna up to 25' with a convenient extension cable (ROAMXL-EXT)
- Simplify Plastic Pedestal installations with a flexible pedestal lid mounting option (PED-LID-ANT-BRKT)

ANTENNA EXTENSION OPTIONS

Model	Description
ANT-EXT-KIT	Universal Antenna Extension Kit for Wi-Fi, cellular, and LoRa communication hardware (9' cable and mounting hardware)
ROAMXL-EXT	ROAM XL Antenna Extension Kit (25' cable and mounting hardware)
PED-LID-ANT-BRKT	Plastic Pedestal Antenna Mount



ANT-EXT-KIT

WATERPROOF WIRE CONNECTOR

Use this approved waterproof connector for EZ-1 Decoders and all above-grade solenoid and sensor wiring connections.

KEY BENEFITS

- 100% silicone-based sealant protects against moisture and corrosion
- Designed as a single-use only connection
- UL Listed (UL486G) to 600 V for use in damp/wet locations or above-grade applications
- Easy to apply, pre-filled twist-on wire connectors
- Eliminates the need for heat-shrink or excessive taping
- Not for use in continual submersion applications; use DBRY-6 Splice Connectors
- Approvals: UL, cUL, FCC, CE, UKCA, RCM, RoHS, ISED

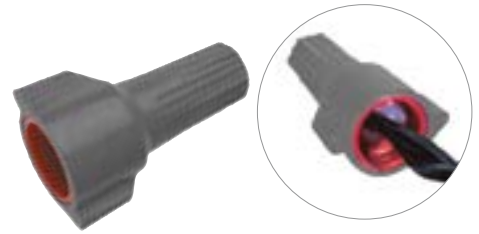

Waterproof Wire Connector

Height: 1½"
Minimum wire: 3 #18 AWG
Maximum wire: 2 #10 AWG with 1 #14 AWG

WIRE CONNECTOR	
Model	Description
WC100	Bulk 100 connectors in canister

WC100 WIRE CONNECTOR



WATERPROOF SPLICE KIT

Use this approved splice kit for all direct-burial, two-wire ICD, and legacy DUAL™ Decoder wiring connections.

KEY BENEFITS

- UL Listed (UL486G) to 600 V for use in damp/wet location or direct-burial applications
- Waterproof, corrosion-proof, UV-rated, and impact resistant
- Snap-fit lid provides strain relief and three wire exits
- Prefilled with silicone that never hardens
- Two-part system includes red/yellow winged wire connector and silicone-filled tube
- Compatible with EZ-1 Decoder connections, but not a requirement
- Approvals: UL, cUL, FCC, CE, UKCA, RCM, RoHS, ISED



Waterproof Splice Kit

Height: 3¾"
Minimum wire: 2-7 #18 AWG
Maximum wire: 2-3 #10 AWG

DBRY-6 SPLICE KIT	
Model	Description
DBRY100	Bulk 100 connectors (100 tubes loose in box, plus inner box with 100 wire nuts)
DBRY2X25	25 x 2-packs (2 tubes and 2 wire nuts in a plastic bag x 25 units)

DBRY-6 WATERPROOF SPLICE KIT



ROAM REMOTE

Enable convenient controller management from a distance with this handheld wireless remote.

KEY BENEFITS

- Compatibility with Hunter X-Core®, X2™, Pro-C®, HPC, ICC2, HCC, ACC2, legacy ACC, and I-Core® Controllers to enable remote management for projects of any size
- Manually start individual stations or programs for quick maintenance checks and troubleshooting
- 128 programmable addresses available prevents cross-communication between multiple remotes within close proximity of each other
- Programmable run times from 1 to 90 minutes, which will not overwrite regular automatic programming
- Manual operation up to 240 stations provides flexibility for larger projects

OPERATING SPECIFICATIONS

- Range: 1,000' from transmitter to receiver
- Transmitter power source: 4 AAA batteries (included)
- Receiver power source: 24 VAC, 0.010 A
- System operating frequency: 433 MHz
- SmartPort® Wiring Harness installation: maximum 50' from controller
- FCC, CE, and UKCA approved for use in the United States and internationally
- Warranty period: 2 years



ROAM Transmitter and Receiver

Height: 7"
Width: 2¼"
Depth: 1¼"



SmartPort Wiring Harness

Hunter remotes require the installation of a SmartPort Wiring Harness, which is a connector that is wired to the terminals on the controller and allows for quick connection to any Hunter receiver.



Wall-Mount Bracket for SmartPort Wiring Harness

P/N 258200

ROAM

Model	Description
ROAM-KIT	Transmitter, receiver, SmartPort Wiring Harness, and 4 AAA batteries
ROAM-TR	Transmitter unit and 4 AAA batteries included
ROAM-R	Receiver unit

USER-INSTALLED OPTIONS

Model	Description
ROAM-WH	SmartPort Wiring Harness (length: 6')
ROAM-SCWH	Shielded SmartPort Wiring Harness (length: 25')
258200	Wall-mount bracket for SmartPort Wiring Harness

ROAM XL REMOTE

Add professional, license-free remote control to projects of any size with this long-range remote.

KEY BENEFITS

- Compatibility with Hunter X-Core®, X2™, Pro-C®, HPC, ICC2, HCC, ACC2, legacy ACC, and I-Core® Controllers to enable remote management for projects of any size
- Manually start individual stations or programs for quick maintenance checks and troubleshooting
- 128 programmable addresses available prevents cross-communication between multiple remotes within close proximity of each other
- Programmable run times from 1 to 90 minutes, which will not overwrite regular automatic programming
- Manual operation up to 240 stations provides flexibility for larger projects
- Rugged and water-resistant transmitter includes a large LCD display with simple push-button operation and a battery-life indicator

OPERATING SPECIFICATIONS

- Range: 2 miles (line of sight) from transmitter to receiver
- Transmitter power source: 4 AAA batteries (included)
- Receiver power source: 24 VAC, 0.010 A
- System operating frequency: 27 MHz
- SmartPort® Wiring Harness installation: maximum 50' from controller
- FCC approved (not available in EU and some other countries; check local regulations)
- Warranty period: 3 years



ROAM XL Transmitter and Receiver

(without antenna)
Height: 6¼"
Width: 3"
Depth: 1¼"



SmartPort Wiring Harness

Hunter remotes require the installation of a SmartPort Wiring Harness, which is a connector that is wired to the terminals on the controller and allows for quick connection to any Hunter receiver.



Wall-Mount Bracket for SmartPort Wiring Harness

P/N 258200

ROAM XL	
Model	Description
ROAMXL-KIT	Transmitter, receiver, SmartPort Wiring Harness, 4 AAA batteries and plastic carrying case included
ROAMXL-TR	Handheld transmitter and 4 AAA batteries included
ROAMXL-R	Receiver unit (SmartPort Wiring Harness included)

USER-INSTALLED OPTIONS	
Model	Description
258200	Wall-mount bracket for SmartPort Wiring Harness
ROAM-WH	SmartPort Wiring Harness (length: 6')
ROAM-SCWH	Shielded SmartPort Wiring Harness (length: 25')
ROAMXL-EXT	ROAM XL Antenna Extension Kit (25' cable and mounting hardware included)

PSR

This reliable and economical Pump Start Relay family is perfect for systems that require pump activation.

KEY BENEFITS

- A pump start relay family for a variety of voltage and power requirements.
- 24 VAC flying leads make connection to the controller quick and easy
- Suitable for conventional wiring or two-wire decoder activation, allows flexible installation options

OPERATING SPECIFICATIONS

- Recommended installation: Minimum 15' from irrigation controller; see chart on page 207 for maximum distances
- Approvals: IP44 (outdoor), UL, cUL, FCC, CE, RCM, ISED
- Warranty period: 2 years



Pump Start Relay

Height: 6½"
Width: 7½"
Depth: 4½"

PUMP START RELAY

Model	Description
PSR-22	Double-pole/single-throw pump start relay for 120 VAC pumps up to 2 hp or 230 VAC pumps up to 3 hp
PSR-52	Double-pole/single-throw pump start relay for 120 VAC pumps up to 3 hp or 230 VAC pumps up to 7.5 hp
PSR-53	Triple-pole/single-throw pump start relay for 120 VAC pumps up to 3 hp, 230 VAC pumps up to 7.5 hp, or 230 VAC pumps up to 10 hp (3-phase)

PUMP START RELAY ELECTRICAL SPECIFICATIONS

Model	Single-Phase		3-Phase**	Max. Full Load AMPS	Max. Resistive AMPS	Coil VA							
	HP at 120 VAC	HP at 230 VAC				INRUSH		HOLDING					
			HP at 230 VAC		50 Hz	60 Hz	50 Hz	60 Hz	50 Hz	60 Hz	50 Hz	60 Hz	
PSR-22	2*	3*	N/A	30	40	33	30	1.38	1.25	8	6.5	0.33	0.27
PSR-52	3	7.5	N/A	40	50	65	60	2.71	2.50	7.5	5	0.31	0.21
PSR-53	3	7.5	10	40	50	65	60	2.71	2.50	7.5	5	0.31	0.21

Note: *Approximate power

** 3-phase power at 230 VAC is not commonly available in some international markets. Check local electrical codes for compatibility.

PSR-B

For distant pump starts that require more power, choose the PSR-B.

KEY BENEFITS

- Provides a solution for irrigation controller and pump start relay installations that have insufficient power to activate the pump
- Includes solid state relay and local 24 VAC transformer for simple PSR activation

OPERATING SPECIFICATIONS

- Primary AC power input: 120/230 VAC
- Secondary AC power output: 24 VAC, 1.6 A
- Relay rating: Double-pole, double-throw solid state (10 A)
- Approvals: IP54 (outdoor), UL, cUL, FCC, CE, RCM, ISED
- Warranty period: 2 years



PSR-B Pump Start Relay Booster

Height: 8¾"
Width: 7"
Depth: 3¾"

PUMP START RELAY BOOSTER

Model	Description
PSR-B	Pump Start Relay Booster for increasing controller output power

CONNECT YOUR WAY

Choose from a range of Wi-Fi, LAN (Ethernet), and cellular connection accessories to enable remote irrigation management on standalone controllers anytime, anywhere.

HYDRAWISE® SOFTWARE

X2 Controller with WAND Module Installed



WAND
Wi-Fi accessory for X2 Controllers, managed by Hydrawise Software
page 101

CENTRALUS™ SOFTWARE

PRO-C Controller with PC-WIFI Module Installed



PC-WIFI
Wi-Fi accessory for Pro-C Controllers, managed by Centralus Software
page 108

CENTRALUS SOFTWARE

ICC2 Controller with LANKIT Module Installed

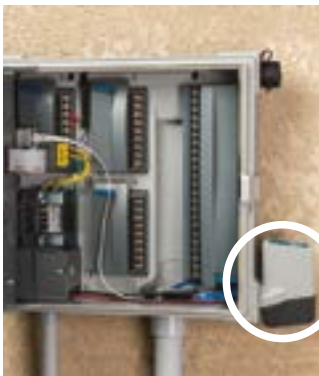

WIFIKIT
Wi-Fi accessory for ICC2 Controllers, managed by Centralus Software
page 108



LANKIT
Ethernet accessory for ICC2 Controllers, managed by Centralus Software
page 108



CELLKIT
Cellular accessory for ICC2 Controllers, managed by Centralus Software
page 108

CENTRALUS SOFTWARE

ACC2 Controller with A2C-LTEM Module installed



A2C-WIFI
Wi-Fi accessory for ACC2 Controllers, managed by Centralus Software
page 111



A2C-LAN
Ethernet accessory for ACC2 Controllers, managed by Centralus Software
page 111



A2C-LTEM
Cellular accessory for ACC2 Controllers, managed by Centralus Software
page 111



SENSORS



SENSOR AND CONTROLLER COMPATIBILITY CHART

AC CONTROLLERS	SENSOR INPUTS	RAIN	SMART WEATHER ADJUST	FLOW*	HIGH-FLOW SHUTOFF
X-CORE® page 95	1	Mini-Clik, Rain-Clik	Solar Sync	N/A	Flow-Clik
X2™ page 100	1	Mini-Clik, Rain-Clik	Hydrawise® Software	N/A	Flow-Clik
PRO-HC page 102	2	Mini-Clik, Rain-Clik	Hydrawise Software	HC Flow Meter	HC Flow Meter
HPC page 103	2	Mini-Clik, Rain-Clik	Hydrawise Software	HC Flow Meter	HC Flow Meter
HCC page 104	2	Mini-Clik, Rain-Clik	Hydrawise Software	HC Flow Meter	HC Flow Meter
ACC2 page 110	1 Solar Sync, 3 Clik, 6 Flow	Mini-Clik, Rain-Clik	Solar Sync, Centralus Software	HFS, WFS, HC Flow Meter, Other (K-Factor or Scaled Pulse)	Built-In, Real-Time Flow Monitoring and Management
ICC2 page 112	2	Mini-Clik, Rain-Clik	Solar Sync, Centralus™ Software	HFS, WFS, HC Flow Meter, Other (K-Factor or Scaled Pulse)	Flow-Clik
PRO-C® page 113	2	Mini-Clik, Rain-Clik	Solar Sync, Centralus Software	HFS, WFS, HC Flow Meter, Other (K-Factor or Scaled Pulse)	Flow-Clik
BATTERY-OPERATED CONTROLLERS					
NODE page 118	1	Mini-Clik, Rain-Clik (wired)	N/A	N/A	N/A
NODE-BT page 119	2	Mini-Clik, Rain-Clik (wired)	N/A	N/A	N/A
XC HYBRID page 120	1	Mini-Clik, Rain-Clik (wired)	N/A	N/A	N/A

*Centralus communication module required for flow sensor input with Pro-C and ICC2 Controllers

SOIL MOISTURE	FREEZE	WIND
Soil-Clik	Freeze-Clik, WR-Clik	Wind-Clik, MWS
Soil-Clik	Freeze-Clik, WR-Clik, Hydrawise Software	Wind-Clik, MWS, Hydrawise Software
Soil-Clik	Freeze-Clik, WR-Clik, Hydrawise Software	Wind-Clik, MWS, Hydrawise Software
Soil-Clik	Freeze-Clik, WR-Clik, Hydrawise Software	Wind-Clik, MWS, Hydrawise Software
Soil-Clik	Freeze-Clik, WR-Clik, Hydrawise Software	Wind-Clik, MWS, Hydrawise Software
Soil-Clik	Freeze-Clik, WR-Clik, Centralus Software	Wind-Clik, MWS
Soil-Clik	Freeze-Clik, WR-Clik, Centralus Software	Wind-Clik, MWS
Soil-Clik	Freeze-Clik, WR-Clik, Centralus Software	Wind-Clik, MWS
N/A	Freeze-Clik	N/A
SC-Probe	Freeze-Clik	N/A
N/A	Freeze-Clik	N/A



Rain-Clik® Sensor



Mini-Clik® Sensor



Soil-Clik® Sensor



Freeze-Clik® Sensor



Wind-Clik® Sensor



Mini Weather Station



Solar Sync® Sensor



Flow-Sync® Sensor



HC Flow Meter Sensor
Available wireless!



Wireless Flow Sensor



Flow-Clik® Sensor

RAIN-CLIK®

To prevent water waste, built-in Quick Response® Technology instantly shuts down irrigation as soon as it starts raining.

KEY BENEFITS

- Quick Response Technology triggers instant rain shutoff
- Freeze sensing model halts system operation at 37°F
- Wireless sensor kit simplifies installation
- Maintenance-free design with integrated battery for wireless models
- Adjustable vent ring allows for shorter or longer reset period
- Includes gutter bracket and wall mount with wireless models
- Compatible with most normally open or normally closed irrigation controllers

OPERATING SPECIFICATIONS

- Quick Response Technology:
 - Time to turn off irrigation system: approximately 2 to 5 minutes for Quick Response
 - Time to reset Quick Response: approximately 4 hours under dry, sunny conditions
 - Time to reset when fully wet: approximately 3 days under dry, sunny conditions
- All models switch rating (24 VAC): 3 A
- Wired models include 25' of 20 AWG sheathed, UL-approved wire
- Wireless model operating frequency: 433 MHz
- Wireless model range is 800' line of sight from sensor to receiver
- Multiple wireless receivers can be operated from a single wireless sensor
- Approvals: UL, cUL, FCC, CE, UKCA, RCM
- Warranty period: 5 years

USER-INSTALLED OPTIONS

- Optional Gutter Mount for wired models (included with WR-CLIK)
- Vandal-resistant Wireless Sensor Guard for flat surface- or pole-mounting (order sensor separately)
- Vandal-resistant Wireless Receiver Guard for pedestal mounting (order receiver separately)

RAIN-CLIK	
Model	Description
RAIN-CLIK	Wired Rain-Clik Sensor
RAIN-CLIK-NO	Wired Rain-Clik Sensor, normally open switch
RFC	Wired Rain/Freeze-Clik Sensor
WR-CLIK	Wireless Rain/Freeze-Clik Sensor, Receiver, and Gutter Mount
WS-GUARD	Vandal-resistant wireless sensor guard for surface- or pole-mounting
WR-GUARD	Vandal-resistant wireless receiver guard for pedestal mounting

Sensor: Rain, Freeze



Wired Rain-Clik Sensor
(with mounting arm)
Height: 2½"
Length: 7"
Width: 1"



Sensor Gutter Mount
optional gutter mount
Height: ½"
Length: 3"
Width: 1¼"



Wireless Rain-Clik Sensor
(with mounting arm)
Height: 3"
Length: 8"
Width: 1"



Wireless Receiver
(with wall-mounting hardware)
Height: 3¼"
Length: 4"
Width: 1½"



Wireless Sensor Guard
(with mounting hardware)
Height: 2¾"
Length: 3¾"
Width: 1¼"



Wireless Receiver Guard
(with mounting hardware)
Height: 5"
Length: 4"
Width: 1¼"

Compatible with:



**Waterproof Wire
Connector**
Page 129

MINI-CLIK®

This sensor halts scheduled irrigation when it detects a preset level of rainfall to prevent water waste.

KEY BENEFITS

- Shuts off irrigation automatically when the sensor detects rainfall from 1/8" to 3/4"
- Debris-tolerant for reliable operation and no unnecessary shutdowns
- Wireless sensor kit simplifies installation*
- Quick Response® Technology triggers faster system shutdown for plant protection*
- Built-in freeze sensing halts system operation at 37°F to protect plants and keep roads and walkways ice-free*
- Maintenance-free design with integrated battery for wireless models
- Compatible with most normally open or normally closed irrigation controllers

OPERATING SPECIFICATIONS

- Quick Response Technology* (when enabled):
 - Time to turn off irrigation system: approximately 2 to 5 minutes
 - Time to reset: approximately 4 hours under dry, sunny conditions
 - Time to reset when fully wet: approximately 3 days under dry, sunny conditions
- All models switch rating (24 VAC): 3 A
- Wired models include 25' of 20 AWG sheathed, UL-approved wire
- Wireless model operating frequency: 433 MHz
- Wireless model range is 800' line of sight from sensor to receiver
- Multiple wireless receivers can be operated from a single wireless sensor
- Approvals: UL, cUL, FCC, CE, UKCA, RCM
- Warranty period: 5 years

USER-INSTALLED OPTIONS

- Optional Gutter Mount for wired models (included with WM-CLIK)
- Vandal-resistant Wireless Sensor Guard for flat surfaces or pole mounting (order sensor separately)
- Vandal-resistant Wireless Receiver Guard for pedestal mounting (order receiver separately)

*Wireless Mini-Clik Sensor only

MINI-CLIK	
Model	Description
MINI-CLIK	Wired Mini-Clik Sensor
MINI-CLIK-NO	Wired Mini-Clik Sensor, normally open switch
MINI-CLIK-C	Wired Mini-Clik Sensor, conduit mount
SG-MC	Wired Mini-Clik Sensor in a stainless steel sensor enclosure
WM-CLIK	Wireless Mini-Clik Sensor, Receiver, and Gutter Mount
WS-GUARD	Vandal-resistant Wireless Sensor Guard for flat surface or pole mounting
WR-GUARD	Vandal-resistant Wireless Receiver Guard for pedestal mounting

Sensor: Rain, Freeze



Wired Mini-Clik Sensor
(with mounting arm)
Height: 2"
Length: 6"
Width: 1"



Wired Mini-Clik Sensor
(with stainless steel enclosure)
Height: 5 1/2"
Length: 3"
Width: 4"



Wireless Mini-Clik Sensor
(with mounting arm)
Height: 3"
Length: 8"
Width: 1"



Wireless Receiver
(with wall-mounting hardware)
Height: 4"
Length: 4"
Width: 1 1/2"



Wireless Sensor Guard
(with mounting hardware)
Height: 2 3/4"
Length: 3 3/4"
Width: 1 1/4"



Wireless Receiver Guard
(with mounting hardware)
Height: 5"
Length: 4"
Width: 1 1/4"

Compatible with:



Waterproof Wire Connector
Page 129

SOLAR SYNC®

This sensor automatically adjusts controller run times daily based on local climate conditions to reduce water usage and improve plant health.

Sensor: **ET, Rain, Freeze**

KEY BENEFITS

- Automatically adjusts irrigation run times based on weather conditions using on-site solar radiation and air temperature
- Quick Response® Technology triggers instant rain shutoff
- Freeze sensing halts system operation at 37°F
- Wireless sensor kit simplifies installation
- Maintenance-free design with integrated battery for wireless models
- Adjustable vent ring allows for shorter or longer reset period
- Use with X-Core®, Pro-C®, ICC2, ACC2, and legacy ACC and I-Core® Controllers
- Manage remotely with Centralus™ Software for Pro-C, ICC2, and ACC2 installations

OPERATING SPECIFICATIONS

- Solar Sync Technology:
 - Adjusts run times daily 3 minutes before midnight using the last 3 days of ET (evapotranspiration) data
 - See calibration table on **page 209**
- Quick Response Technology:
 - Time to turn off irrigation system: approximately 2 to 5 minutes for Quick Response
 - Time to reset Quick Response: approximately 4 hours under dry, sunny conditions
 - Time to reset when fully wet: approximately 3 days under dry, sunny conditions
- All models switch rating (24 VAC): 3 A
- Wired models include 25' of 20 AWG sheathed, UL-approved wire
- Wireless model operating frequency: 433 MHz
- Wireless model range is 800' line of sight from sensor to receiver
- Multiple wireless receivers can be operated from a single wireless sensor
- Approvals: UL, cUL, FCC, CE, UKCA, RCM
- Warranty period: 5 years

USER-INSTALLED OPTIONS

- Vandal-resistant Wireless Sensor Guard for flat surface- or pole-mounting (order sensor separately)
- Vandal-resistant Wireless Receiver Guard for pedestal mounting (order receiver separately)

SOLAR SYNC	
Model	Description
SOLAR-SYNC-SEN	Wired Solar Sync Sensor and Gutter Mount
WSS-SEN	Wireless Solar Sync Sensor, Receiver, and Gutter Mount
WS-GUARD	Vandal-resistant Wireless Sensor Guard for flat surface- or pole-mounting
WR-GUARD	Vandal-resistant Wireless Receiver Guard for pedestal mounting



Wired Solar Sync Sensor
(with mounting arm)
Height: 3"
Length: 8½"
Width: 1"



Wireless Solar Sync Sensor
Height: 4½"
Length: 8½"
Width: 1"



Wireless Solar Sync Receiver
(with wall-mounting kit)
Height: 5½"
Length: 1½"
Width: 1½"



Wireless Sensor Guard
(with mounting hardware)
Height: 2¾"
Length: 3¾"
Width: 1¼"



Wireless Receiver Guard
(with mounting hardware)
Height: 5"
Length: 4"
Width: 1¼"

Compatible with:



Centralus Software
Page 108



Waterproof Wire Connector
Page 129



EPA WaterSense® Approved
Recognized as a responsible water-saving tool by the U.S. Environmental Protection Agency

SOIL-CLIK®

Sensor: **Soil Moisture**

This sensor prevents water waste by measuring soil moisture and shutting off irrigation when a preset level is reached.

KEY BENEFITS

- View current soil moisture level and status at a glance
- One-touch override allows soil moisture bypass for special conditions
- Low-voltage outdoor enclosure powered by host controller
- Connect to sensor inputs, or use to interrupt common wires in virtually any 24 VAC irrigation system
- Use with Solar Sync® Sensor for maximum water savings; **see page 140**

OPERATING SPECIFICATIONS

- Switch rating (24 VAC): 5 A
- Input power (24 VAC): 100 mA
- Output power: Normally closed, dry-contact closure
- 6' maximum distance from Soil-Clik module to controller
- 1,000' maximum distance from Soil-Clik module to sensor probe for AC installations
- 100' maximum distance for NODE-BT installations
- Sensor probe includes 30" of direct-burial wire
- Approvals: UL, cUL, FCC, CE, UKCA, RCM
- Warranty period: 5 years

Soil-Clik Module

Height: 4½"
Length: 3½"
Width: 1¼"



Soil-Clik Probe

Height: 3¼"
Diameter: 1"



SENSORS

SOIL-CLIK

Model	Description
SOIL-CLIK	Soil-Clik moisture sensor module and probe
SC-PROBE	Soil moisture probe sensor for NODE-BT (module is not used)

Probe installed in root zone to monitor soil moisture

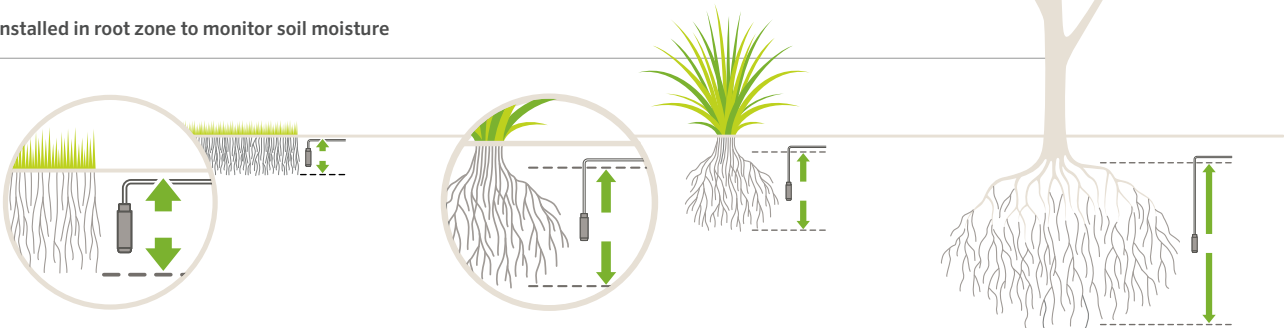

Compatible with:



Waterproof Wire Connector
Page 129



NODE-BT Controller
Page 119

In turf applications, the probe should be placed in the root zone, approximately 6" deep (adjust for actual turf conditions).

For shrubs or trees, select a deeper depth that matches the root zone. For new plantings, choose a spot halfway down the root ball, adjacent to native soil.

HC FLOW METER

Sensor: **Flow**

Detect, monitor, and report critical flow zone data via wired or wireless connection with this robust and simple-to-install flow sensor.

KEY BENEFITS

- Compatible with Hydrowise® enabled HC, Pro-HC, HPC, and HCC Controllers as well as Centralus™ enabled Pro-C®, ICC2, and ACC2 Controllers
- Provides station-level flow rates and totals
- Sends automatic alerts in the event of high-flow, low-flow, or unscheduled flow conditions
- Flow reports within Hydrowise Software can display total system water use and individual station water use for accurate water budgeting and tracking
- Robust brass construction with union fittings for easy installation and removal for winterization
- Analog dial on the face of the meter displays daily flow totals

OPERATING SPECIFICATIONS

- Scaled pulse output is precalibrated from the factory based on the size of the meter
- When wired directly to the controller, the meter must be installed with shielded, minimum 18 AWG wire, up to 1,000' from the controller
- Accuracy: ± 2% of reading at recommended flow
- Warranty period: 2 years

WIRELESS HC FLOW METER BENEFITS

- Add wireless communication to any HC Flow Meter (sensor sold separately)
- Send flow data wirelessly from the sensor to the controller, without the need to run wire or dig trenches



HC-075-FLOW
(¾" male thread)
Height: 3⅞"
Length: 9⅞"
Depth: 3⅞"

HC-150-FLOW
(1½" male thread)
Height: 6¼"
Length: 16⅞"
Depth: 4⅞"

HC-100-FLOW
(1" male thread)
Height: 3⅝"
Length: 10¼"
Depth: 3⅝"

HC-200-FLOW
(2" male thread)
Height: 6¼"
Length: 17½"
Depth: 4⅞"

WIRELESS HC FLOW METER



WIRELESS HC FLOW METER MODELS

Model	Description
W-HC-FLOW	Wireless HC Flow Meter Kit, includes transmitter and receiver (domestic 900 MHz)
HC-075-FLOW	HC Flow Meter with ¾" male thread, U.S. gal
HC-100-FLOW	HC Flow Meter with 1" male thread, U.S. gal
HC-150-FLOW	HC Flow Meter with 1½" male thread, U.S. gal
HC-200-FLOW	HC Flow Meter with 2" male thread, U.S. gal

HC FLOW METER SPECIFICATIONS				
	HC-075-FLOW (¾")	HC-100-FLOW (1")	HC-150-FLOW (1½")	HC-200-FLOW (2")
Minimum flow (GPM)	0.22	0.3	0.88	1.98
Maximum recommended flow (GPM)	15	30	66	105
Maximum flow (GPM)	21	34	88	132
Dial reading (U.S. gal)	1 pulse per 0.1 U.S. gal	1 pulse per 1 U.S. gal	1 pulse per 1 U.S. gal	1 pulse per 1 U.S. gal

WIRELESS HC FLOW METER OPERATING SPECIFICATIONS

- 500' range (line of sight) from transmitter to receiver
- Communication frequency: 900 MHz for use in North America
- Transmitter power supply: 3 AA batteries
- Receiver power supply: 24 VAC from host controller
- Warranty period: 2 years

HC FLOW METER Pressure Loss Chart

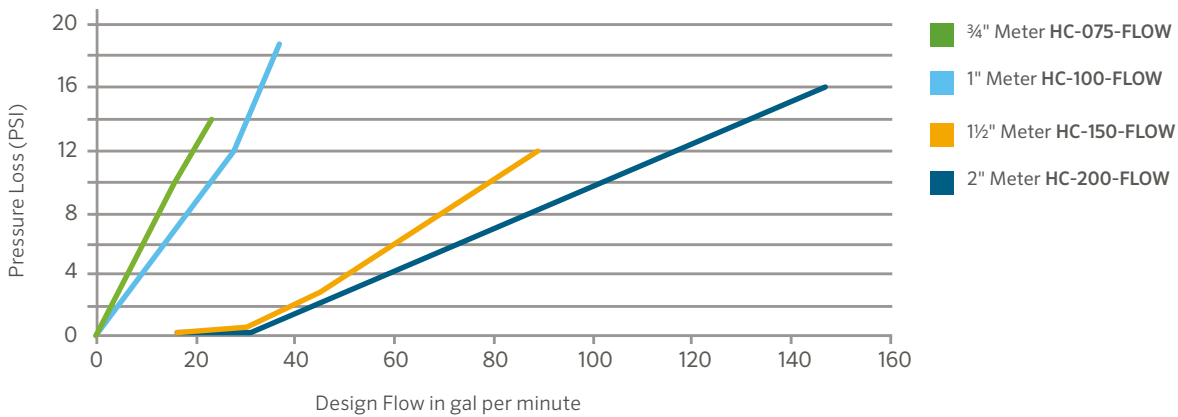

FLOW-CLIK®

Add high-flow shutoff capabilities to any irrigation controller with this simple, adjustable device.

KEY BENEFITS

- Automatically shuts down entire system if an overflow condition occurs, helping to protect against flood damage and erosion
- Single-button calibration to set highest flow rate
- User-adjustable timing and delay for sensor response
- Compatible with all Hunter AC-powered controllers for a variety of applications
- Multi-color LED indicates system status and if flow is within limits

OPERATING SPECIFICATIONS

- Recommended pressure range: 0 to 220 PSI
- Current draw (24 VAC): 0.025 A
- Switching current: 2 A maximum
- Sensor wiring: 2 x direct burial, 18 AWG or greater, color-coded or marked for polarity, up to 1,000' from the interface module
- Programmable start up delay: 0 to 300 seconds (allows for system hydraulics to stabilize and prevents false flow readings)
- Programmable interrupt period: 5 to 60 minutes (or option to reset manually)
- Warranty period: 5 years

USER-INSTALLED OPTIONS

- FCT fittings for 1" to 4" pipe diameters

Sensor: **Flow**



Flow-Clik sensor and module shown with required FCT fitting for pipe installation (sold separately)

Flow-Clik Module:

Height: 6"
Width: 5¾"
Depth: 2¼"

Flow-Clik Sensor

Height: 3½"
Diameter: 1½"

Compatible with:



**Waterproof
Splice Kit**
[Page 129](#)

FLOW-CLIK

Model	Description
FLOW-CLIK	Standard kit for all 24 VAC controllers. <i>Includes sensor and interface module, sensor requires FCT for pipe installation.</i>

REQUIRED USER-INSTALLED OPTION (SPECIFY SEPARATELY)

Model	Description
FCT-100	1" Schedule 40 sensor (white) receptacle tee
FCT-150	1½" Schedule 40 sensor (white) receptacle tee
FCT-158	1½" Schedule 80 sensor (gray) receptacle tee
FCT-200	2" Schedule 40 sensor (white) receptacle tee
FCT-208	2" Schedule 80 sensor (gray) receptacle tee
FCT-300	3" Schedule 40 sensor (white) receptacle tee
FCT-308	3" Schedule 80 sensor (gray) receptacle tee
FCT-400	4" Schedule 40 sensor (white) receptacle tee

FLOW RANGE

Pipe Diameter	Operating Range (GPM)	
	Minimum	Suggested Maximum*
1"	2	17
1½"	5	35
2"	10	55
3"	28	120
4"	34	200

Note:

* Good design practice dictates the maximum flow not to exceed 5'/sec. Suggested maximum flow is based upon Class 200 IPS plastic pipe.

FLOW-SYNC®

This cost-effective flow sensor is designed for use with commercial controllers.

Sensor: **Flow**

KEY BENEFITS

- Simple-insertion flow sensor for metering and reacting to real-time flow conditions
- Provides station-level flow monitoring for reaction to high- or low-flow conditions, helping to protect against flood damage and erosion
- Compatible with Hunter ACC2 and legacy ACC and I-Core® Controllers, ICD-SEN Sensor Decoders, and Pro-C® and ICC2 Centralus Communication Modules
- Easy connection up to 1,000' from controller or sensor decoder
- Sensor is precalibrated for K-Factor and Offset based on pipe size, allowing for quick setup and programming within the controller

OPERATING SPECIFICATIONS

- Recommended pressure range: 0 to 220 PSI
- Pressure loss: < 1 PSI
- Sensor wiring: 2 x direct burial, 18 AWG or greater, color-coded or marked for polarity, up to 1,000' from the controller
- Warranty period: 5 years

USER-INSTALLED OPTIONS

- FCT tee fittings for pipe installation



Impeller-type flow sensor, requires FCT fitting for pipe installation (order separately)

Compatible with:



**ACC2
Controllers**
Page 110

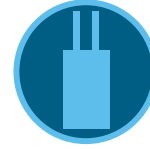

**ICD-SEN
Decoder**
Page 125



**Waterproof
Splice Kit**
Page 129

SENSORS

FLOW-SYNC	
Model	Description
HFS	Hunter Flow-Sync Sensor for use with ACC2 and legacy ACC and I-Core® Controllers

REQUIRED USER-INSTALLED OPTION (SPECIFY SEPARATELY)	
Model	Description
FCT-100	1" Schedule 40 sensor receptacle tee
FCT-150	1½" Schedule 40 sensor receptacle tee
FCT-158	1½" Schedule 80 sensor receptacle tee
FCT-200	2" Schedule 40 sensor receptacle tee
FCT-208	2" Schedule 80 sensor receptacle tee
FCT-300	3" Schedule 40 sensor receptacle tee
FCT-308	3" Schedule 80 sensor receptacle tee
FCT-400	4" Schedule 40 sensor receptacle tee

FLOW RANGE		
Pipe Diameter	Operating Range (GPM)	
	Minimum	Suggested Maximum*
1"	2	17
1½"	5	35
2"	10	55
3"	28	120
4"	34	200

Note:

* Good design practice dictates the maximum flow not to exceed 5'/sec. Suggested maximum flow is based upon Class 200 IPS plastic pipe.

WFS

Use this sensor to retrofit flow to existing systems that cross under asphalt, concrete, or other hardscapes.

KEY BENEFITS

- Wireless flow sensor saves time, materials, and labor
- Simple-insertion flow sensor for monitoring and reacting to real-time flow conditions
- Provides station-level flow monitoring for reaction to high- or low-flow conditions, helping to protect against waste and damage from leaks
- Compatible with Hunter ACC2 and legacy ACC and I-Core® Controllers, and Pro-C® and ICC2 Centralus™ Communication Modules
- Sensor is precalibrated for K-Factor and Offset based on pipe size, allowing for quick setup and programming within the controller
- Multi-color LED on the receiver indicates proper communication to the transmitter, as well as remaining battery life

OPERATING SPECIFICATIONS

- Maximum distance sensor to receiver: 500'
- Recommended pressure range: 0 to 220 PSI
- Pressure loss: < 1 PSI
- Approvals: FCC and CE approved
- Warranty period: 5 years

USER-INSTALLED OPTIONS

- FCT tee fittings for pipe installation

Sensor: **Flow**



WFS Transmitter

Height: 5½"
Diameter: 4¼"

WFS Sensor

Height: 3¾"
Diameter: 2¼"

WFS Receiver

Height: 5"
Width: 3"
Depth: 1½"

Compatible with:



**ACC2
Controllers**
Page 110

WIRELESS FLOW SENSOR

Model	Description
WFS	Wireless Flow Sensor Kit – Domestic 900 MHz
WFS-T	Wireless Flow Sensor Kit Transmitter Only – Domestic 900 MHz
WFS-R	Wireless Flow Sensor Kit Receiver Only – Domestic 900 MHz
WFS-ALKBATT	Wireless Flow Sensor Alkaline Battery with Cage

REQUIRED USER-INSTALLED OPTION (SPECIFY SEPARATELY)

Model	Description
FCT-100	1" Schedule 40 sensor (white) receptacle tee
FCT-150	1½" Schedule 40 sensor (white) receptacle tee
FCT-158	1½" Schedule 80 sensor (gray) receptacle tee
FCT-200	2" Schedule 40 sensor (white) receptacle tee
FCT-208	2" Schedule 80 sensor (gray) receptacle tee
FCT-300	3" Schedule 40 sensor (white) receptacle tee
FCT-308	3" Schedule 80 sensor (gray) receptacle tee
FCT-400	4" Schedule 40 sensor (white) receptacle tee

FLOW RANGE

Pipe Diameter	Operating Range (GPM)	
	Minimum	Suggested Maximum*
1"	2	17
1½"	5	35
2"	10	55
3"	28	120
4"	34	200

Note:

* Good design practice dictates the maximum flow not to exceed 5'/sec. Suggested maximum flow is based upon Class 200 IPS plastic pipe.





WORK SMARTER, NOT HARDER ABOVE AND BELOW

Use the Solar Sync Sensor with the Soil-Clik Sensor to measure both climate and soil conditions. Solar Sync uses ET to adjust application amounts when irrigation is needed. Soil-Clik prevents watering when proper soil moisture levels have been reached. Together, they're the ultimate environmentally responsive solution.

Solar Sync® Sensor Above

- **Water-Saving:** Automatically adjusts run times based on local weather conditions
- **Responsive:** Shuts down irrigation during rainfall and freezing conditions
- **Convenient:** Wired or wireless models available

Soil-Clik® Sensor Below

- **Water-Saving:** Measures soil moisture and prevents unnecessary irrigation
- **Easy:** Simple installation and push-button operation
- **Flexible:** Use with any Hunter AC-powered controller and most other brands









MICRO

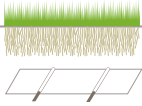
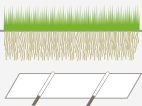

MICRO

MICRO IRRIGATION SOLUTIONS

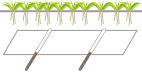
From ultra-durable Hunter Dripline to our innovative Root Zone Watering System, Hunter's micro irrigation solutions are designed to apply water efficiently and precisely where it's needed. Choose the combination of products best suited for your application and plant type using the chart below.

COMMON MICRO APPLICATIONS GUIDE		
APPLICATION	STANDARD DESIGN	ADVANCED DESIGN
TREES 	MLD, Emitters, Micro Sprays, HDL	HDL-COP, Eco-Wrap®, IH Risers, RZWS
MIXED PLANTINGS 	MLD, Micro Sprays, HDL, Single-Port Emitters	HDL-COP, Multi-Port Emitters, Eco-Wrap
SLOPED AREAS 	MLD, Micro Sprays, HDL-PC, HDL-R, Emitters, RZB	HDL-CV, Eco-Mat®, Eco-Wrap, HDL-COP, IH Risers, RZWS
TURF 	HDL-COP	Eco-Wrap, Eco-Mat
SUBSURFACE 	HDL-COP	Eco-Wrap, Eco-Mat
SPARSE PLANTING 	Emitters	IH Risers
DENSE PLANTING 	Micro Sprays, HDL	HDL-COP, Eco-Wrap, Eco-Mat
GREEN ROOFS 	Eco-Mat, Eco-Wrap	Eco-Mat, Eco-Wrap
POTTED PLANTS 	Single-Port Emitters, Micro Sprays	MLD
RECLAIMED 	MLD, Micro Sprays, Emitters	HDL-R, IH Risers, RZWS

CONTROL ZONE KITS

ADVANCED FEATURES

TOTAL RELIABILITY



Every Hunter valve is water-tested to verify reliability, durability, and performance.

DURABLE FILTER



All Hunter filters offer a stainless steel screen and low pressure loss. 1½" and 2" filter bodies offer sizes of 80, 120, and 150 mesh with a 120-mesh disc filter.

ULTIMATE CONVENIENCE



Kits are preassembled to save time and labor in the field. With a highly compact design, they maximize space in the valve box.

PRECISE REGULATION



Senninger® regulators are the most trusted regulators in the industry. Each regulator is water-tested before leaving the factory to ensure years of life in the field.

COMPARISON CHART



TOP FEATURES	PCZ	ACZ	ICZ	IBZ
PREASSEMBLED FOR TIME SAVINGS	●	●	●	
ABOVE-GROUND INSTALLATION		●		
FILTER SENTRY® MECHANISM			●	●
ROBUST, STAINLESS STEEL SCREEN	●	●	●	●
TOP-RATED SENNINGER REGULATOR	●	●	●	●
VALVES 100% WATER-TESTED	●	●	●	●
REGULATORS 100% WATER-TESTED	●	●	●	●
LOW FRICTION LOSS	●	●	●	●
RECLAIMED COMPONENTS	●	●	●	●
CAPABILITY OF DISC FILTRATION			●	●
HIGHEST FLOW OPTION (100 GPM)			●	●
FLOW CONTROL	●	●	●	●
APPLICATION	Residential	Residential	Commercial	Commercial
WARRANTY	2 Years	2 Years	5 Years	5 Years

PCZ

Make installations quick and easy using this robust, preassembled kit with stainless steel filtration and pressure regulation.

KEY BENEFITS

- Factory-assembled for quick and easy installation
- Valves 100% water-tested to ensure dependable operation
- Senninger regulator provides precise regulation to protect system from high pressure
- 150 mesh (100 microns) stainless steel screen for years of reliable filtration

FACTORY-INSTALLED OPTIONS

- 25 or 40 PSI regulator

USER-INSTALLED OPTIONS

- Reclaimed water ID handle for ACZ-075 and PCZ-101: P/N 269205

PCZ-101

- 1" x 3/4" inline valve
- Pressure regulation: 25 or 40 PSI
- Flow: 0.5 to 15 GPM (30 to 900 GPH)
- Operating pressure: 20 to 120 PSI
- Operating temperature: up to 120°F
- 150 mesh stainless steel screen

SOLENOID OPERATING SPECIFICATIONS

- Heavy-duty solenoid: 24 VAC
 - 350 mA inrush current, 190 mA holding current, 60 Hz
 - 370 mA inrush current, 210 mA holding current, 50 Hz
- Warranty period: 2 years



PCZ-101
Height: 7"
Width: 3"
Length: 10"
1" inlet x 3/4" outlet

DRIP CONTROL ZONE KITS

Model	Description
PCZ-101-25	1" PGV flow control valve with HFR-100-75 and 25 PSI regulator
PCZ-101-40	1" PGV flow control valve with HFR-100-75 and 40 PSI regulator

PCZ AND ACZ KITS

System Flow	PCZ-101-25 (25 PSI outlet)	PCZ-101-40 (40 PSI outlet)	ACZ-25 (25 PSI outlet)	ACZ-40 (40 PSI outlet)
GPM	Inlet pressure required to achieve desired outlet pressure (PSI)			
0.5	34	41	25	41
1	34	42	26	43
5	34	45	28	47
10	37	52	30	52
15	41	59	32	55

40 PSI pressure regulator may not be required if the dynamic pressure of an irrigation system is below 60 PSI.

25 PSI pressure regulator may not be required if the dynamic pressure of an irrigation system is below 45 PSI.

CONTROL ZONE KITS

ACZ

This sturdy, preassembled kit includes filtration and pressure regulation for above-ground installations with no additional backflow prevention.

ACZ-075

- 3/4" x 3/4" anti-siphon valve
- Pressure regulation: 25 or 40 PSI
- Flow: 0.5 to 15 GPM (30 to 900 GPH)
- Operating pressure: 20 to 120 PSI
- Operating temperature: up to 120°F
- 150 mesh stainless steel screen

ACZ-101

- 1" x 3/4" anti-siphon valve
- Pressure regulation: 25 or 40 PSI
- Flow: 0.5 to 15 GPM (30 to 900 GPH)
- Warranty period: 2 years
- Operating pressure: 20 to 120 PSI
- Operating temperature: up to 120°F
- 150 mesh stainless steel screen



ACZ-075
Height: 11 1/2"
Width: 3"
Length: 12"
3/4" inlet x 3/4" outlet

ACZ-101
Height: 11 1/2"
Width: 3"
Length: 12"
1" inlet x 3/4" outlet

DRIP CONTROL ZONE KITS

Model	Description
ACZ-075-25	3/4" PGV-ASV valve with HFR-075 and 25 PSI regulator
ACZ-075-40	3/4" PGV-ASV valve with HFR-075 and 40 PSI regulator
ACZ-101-25	1" PGV-ASV valve with HFR-100-075 and 25 PSI regulator
ACZ-101-40	1" PGV flow control valve with HFR-100-75 and 40 PSI regulator

1" ICZ

The most durable kit in the industry is offered in low-, medium-, and high-flow options for diverse system needs.

KEY BENEFITS

- Highest-quality components
- Factory-assembled to save installation time
- Filter Sentry® Mechanism screen-cleaning system (on all models except ICZ-101-LF)
- Wide flow range to cover most micro irrigation applications
- Warranty period: 5 years

FACTORY-INSTALLED OPTIONS

- 25 or 40 PSI regulator

USER-INSTALLED OPTIONS

- Reclaimed water ID handle: P/N 561205

ICZ-101

- Factory-installed Filter Sentry Mechanism
- Pressure regulation: 25 or 40 PSI
- Flow: 2 to 20 GPM (120 to 1,200 GPH)
- System operating pressure: Up to 120 PSI
- Operating temperature: Up to 120°F
- 150 mesh stainless steel screen
- 1" inlet and 1" outlet

ICZ-101-LF

- Pressure regulation: 25 or 40 PSI
- Flow 0.5 to 15 GPM (30 to 900 GPH)
- Fits Multi-Purpose Box
- System operating pressure: Up to 120 PSI
- Operating temperature: Up to 120°F
- 150 mesh stainless steel screen
- 1" inlet and ¾" outlet

ICZ-101-LF-R

- Pressure regulation: 25 or 40 PSI
- Flow 0.5 to 15 GPM (30 to 900 GPH)
- Fits Multi-Purpose Box
- System operating pressure: Up to 120 PSI
- Operating temperature: Up to 120°F
- 150 mesh (100 microns) stainless steel screen
- 1" inlet and ¾" outlet
- Reclaimed water ID tag, purple flow control knob, Filter Sentry Mechanism, and purple chlorine-resistant diaphragm

SOLENOID OPERATING SPECIFICATIONS

- Heavy-duty solenoid: 24 VAC
 - 350 mA inrush current, 190 mA holding current, 60 cycles
 - 370 mA inrush current, 210 mA holding current, 50 cycles
- Warranty period: 5 years



ICZ-101

Height: 6¾"
Width: 4"
Length: 14"
1" inlet x 1" outlet



ICZ-101-LF

Height: 7"
Width: 4"
Length: 10½"
1" inlet x ¾" outlet



ICZ-101-LF-R

Height: 7"
Width: 4"
Length: 10½"
1" inlet x ¾" outlet

ICZ-101 KITS

GPM	Required Pressure for 25 PSI Outlet	Required Pressure for 40 PSI Outlet
2	35	52
5	35	52
7	36	54
10	40	58
15	46	66
20	60	82

ICZ-101 (LOW-FLOW) KITS

GPM	Required Pressure for 25 PSI Outlet	Required Pressure for 40 PSI Outlet
0.5	35	41
1	35	43
5	36	47
10	37	52
15	40	55

40 PSI pressure regulator may not be required if the dynamic pressure of an irrigation system is below 60 PSI.

25 PSI pressure regulator may not be required if the dynamic pressure of an irrigation system is below 45 PSI.

DRIP CONTROL ZONE KITS – SPECIFICATION BUILDER: ORDER 1 + 2

1 Model	2 Options
ICZ-101 = 1" ICV globe valve with Filter Sentry Mechanism and 1" HY-100 Filter and Regulator	25 = 25 PSI regulator
ICZ-101-LF = 1" ICV globe valve with 1" HFR-100-075 Filter Regulator	40 = 40 PSI regulator
ICZ-101-LF-R = 1" ICV reclaimed valve with Filter Sentry Mechanism and 1" x ¾" reclaimed Hunter Filter Regulator	

Example:

ICZ-101-40 = 1" ICV globe valve with Filter Sentry Mechanism and 1" HY-100 Filter Regulator, and 1" outlet 40 PSI regulator

1½" AND 2" ICZ

The toughest plastic valve available comes backed by glass-filled construction, a fabric-reinforced diaphragm, and a double-beaded diaphragm seal.

KEY BENEFITS

- Highest-quality components set Hunter kits apart
- Highest flow options in the industry
- Factory-assembled to save installation time
- Filter Sentry® Mechanism screen-cleaning system

USER-INSTALLED OPTIONS

- Reclaimed water ID handle: P/N 561205

ICZ-151-XL

Operating Specifications

- Pressure regulation: 40 PSI
- Flow: 20 to 80 GPM
- Operating pressure: Up to 120 PSI
- Operating temperature: Up to 120°F
- Standard filter screen: 150 mesh; stainless steel
- Optional filter screens: 80 mesh; 120 mesh; stainless steel
- Disc filter available: 120 mesh

ICZ-201-XL

- Pressure regulation: 40 PSI
- Flow: 20 to 100 GPM
- Operating pressure: Up to 120 PSI
- Operating temperature: Up to 120°F
- Standard filter screen: 150 mesh; stainless steel
- Optional filter screens: 80 mesh; 120 mesh; stainless steel
- Disc filter available: 120 mesh

SOLENOID OPERATING SPECIFICATIONS

- Heavy-duty solenoid: 24 VAC
 - 350 mA inrush current, 190 mA holding current, 60 cycles
 - 370 mA inrush current, 210 mA holding current, 50 cycles
- Warranty period: 5 years
- Additional charts on [page 209](#)



ICZ-151-XL

Height: 9"
Width: 5½"
Length: 22½"
1½" inlet x 2" outlet



ICZ-201-XL

Height: 12"
Width: 7"
Length: 26"
2" inlet x 2" outlet

CONTROL ZONE KITS

DRIP CONTROL ZONE KITS	
Model	Description
ICZ-151-40-XL	1½" ICV globe valve with 1½" filter and 2" regulator
ICZ-201-40-XL	2" ICV globe valve with 2" filter and 2" regulator

ICZ-151 AND ICZ-201 KITS		
Model	System Flow GPM	Required Pressure for 40 PSI Outlet
ICZ-151-40-XL	20	45
	30	50
	40	50
	50	50
	60	60
	70	60
	80	65
ICZ-201-40-XL	20	45
	30	45
	40	45
	50	50
	60	50
	70	50
	80	50
	90	55
	100	55

40 PSI pressure regulator may not be required if the dynamic pressure of an irrigation system is below 60 PSI.

1" IBZ

This heavy-duty kit includes a brass valve and is offered in low-, medium-, and high-flow options for diverse system needs.

KEY BENEFITS

- Highest-quality components
- Ability to handle extremely low flows; suitable for drip irrigation
- Filter Sentry® Mechanism to keep the screen clear of debris
- Wide flow range to cover most micro irrigation applications
- Warranty period: 5 years

FACTORY-INSTALLED OPTIONS

- 25 or 40 PSI regulator

IBZ-101

- Factory-installed Filter Sentry Mechanism
- Pressure regulation: 25 or 40 PSI
- Flow: 2 to 20 GPM (120 to 1,200 GPH)
- System operating pressure: Up to 120 PSI
- Operating temperature: Up to 120°F
- 150 mesh stainless steel screen
- 1" inlet and 1" outlet

IBZ-101-LF

- Factory-installed Filter Sentry Mechanism
- Pressure regulation: 25 or 40 PSI
- Flow 0.5 to 15 GPM (30 to 900 GPH)
- Fits Multi-Purpose Box
- System operating pressure: Up to 120 PSI
- Operating temperature: Up to 120°F
- 150 mesh stainless steel screen
- 1" inlet and ¾" outlet



IBZ-101

Height: 6¾"
Width: 4"
Length: 13¾"
1" inlet x 1" outlet



IBZ-101-LF

Height: 7"
Width: 4"
Length: 10¼"
1" inlet x ¾" outlet

SOLENOID OPERATING SPECIFICATIONS

- Heavy-duty solenoid: 24 VAC
 - 350 mA inrush current, 190 mA holding current, 60 cycles
 - 370 mA inrush current, 210 mA holding current, 50 cycles
- Warranty period: 5 years

IBZ-101 KITS

GPM	Required Pressure for 25 PSI Outlet	Required Pressure for 40 PSI Outlet
2	35	52
5	35	52
7	36	54
10	40	58
15	46	66
20	60	82

IBZ-101-LF (LOW-FLOW) KITS

GPM	Required Pressure for 25 PSI Outlet	Required Pressure for 40 PSI Outlet
0.5	35	41
1	35	43
5	36	47
10	37	52
15	40	55

40 PSI pressure regulator may not be required if the dynamic pressure of an irrigation system is below 60 PSI.

25 PSI pressure regulator may not be required if the dynamic pressure of an irrigation system is below 45 PSI.

BRASS VALVE DRIP CONTROL ZONE KITS - SPECIFICATION BUILDER: ORDER 1 + 2

1 Model	2 Options
IBZ-101 = 1" IBV brass globe valve with Filter Sentry Mechanism and 1" HY100 Filter and Regulator	25 = 25 PSI regulator
IBZ-101-LF = 1" IBV brass globe valve with Filter Sentry Mechanism and 1" HFR-100-075 Filter Regulator	40 = 40 PSI regulator

Example:

IBZ-101-40 = 1" brass globe valve with Filter Sentry Mechanism and 1" HY100 filter and regulator, and 1" outlet 40 PSI regulator

Note: Assembled at site. Kit components ship loose to avoid transit damages.

1½" AND 2" IBZ

This kit offers a heavy-duty brass valve backed by glass-filled construction, a fabric-reinforced diaphragm, and a double-beaded diaphragm seal.

KEY BENEFITS

- Highest-quality components set Hunter kits apart
- Highest flow options in the industry
- Filter Sentry® Mechanism screen-cleaning system

IBZ-151-XL

- Pressure regulation: 40 PSI
- Flow: 20 to 80 GPM
- Operating pressure: up to 120 PSI
- Operating temperature: up to 120°F
- Standard filter screen: 150 mesh; stainless steel
- Optional filter screens: 80 mesh; 120 mesh; stainless steel
- Disc filter available: 120 mesh

IBZ-201-XL

- Pressure regulation: 40 PSI
- Flow: 20 to 100 GPM
- Operating pressure: up to 120 PSI
- Operating temperature: up to 120°F
- Standard filter screen: 150 mesh; stainless steel
- Optional filter screens: 80 mesh; 120 mesh; stainless steel
- Disc filter available: 120 mesh

SOLENOID OPERATING SPECIFICATIONS

- Heavy-duty solenoid: 24 VAC
 - 350 mA inrush current, 190 mA holding current, 60 cycles
 - 370 mA inrush current, 210 mA holding current, 50 cycles
- Warranty period: 5 years



IBZ-151-XL

Height: 9"
Width: 5½"
Length: 22"
1½" inlet x 2" outlet



IBZ-201-XL

Height: 12"
Width: 7"
Length: 25¼"
2" inlet x 2" outlet

CONTROL ZONE KITS

BRASS VALVE DRIP CONTROL ZONE KITS	
Model	Description
IBZ-151-40-XL	1½" IBV globe valve with 1½" filter and 2" regulator
IBZ-201-40-XL	2" IBV globe valve with 2" filter and 2" regulator

Notes: Assembled at site. Kit components ship loose to avoid transit damages. IBZ-151-40-XL assembly requires user-supplied P/N: 439251; 2" MPT x 1" FPT PVC bushing.

IBZ-151 AND IBZ-201 KITS		
Model	System Flow GPM	Required Pressure for 40 PSI Outlet
IBZ-151-40-XL	20	45
	30	50
	40	50
	50	50
	60	60
	70	60
	80	65
IBZ-201-40-XL	20	45
	30	45
	40	45
	50	50
	60	50
	70	50
	80	50
	90	55
	100	55

40 PSI pressure regulator may not be required if the dynamic pressure of an irrigation system is below 60 PSI.

FILTER REGULATORS

This all-in-one choice features a state-of-the-art Senninger regulator and a stainless steel filter screen.

KEY BENEFITS

- HFR-075 (Hunter filter regulator)
 - Compact, all-in-one filter and regulator minimize required valve box space
 - Senninger regulator provides precise regulation to protect system from high pressure
 - 150 mesh (100 microns) stainless steel screen for years of reliable filtration
 - Wide flow range covers most drip applications
- Warranty period: 2 years



HFR-075-25

HFR-075-40

Height: 7"
Width: 2¾"
Length: 6¼"
¾" inlet x ¾" outlet



HFR-100-075-25

HFR-100-075-40

Height: 7"
Width: 2¾"
Length: 6¼"
1" inlet x ¾" outlet



HFR-100-075-25-R

HFR-100-075-40-R

Height: 7"
Width: 2¾"
Length: 6¼"
1" inlet x ¾" outlet

HUNTER FILTER REGULATORS

Model	Description
HFR-075-25	¾" inlet x ¾" outlet, regulated at 25 PSI
HFR-075-40	¾" inlet x ¾" outlet, regulated at 40 PSI
HFR-100-075-25	1" inlet x ¾" outlet, regulated at 25 PSI
HFR-100-075-25-R	1" inlet x ¾" outlet, regulated at 25 PSI, reclaimed
HFR-100-075-40	1" inlet x ¾" outlet, regulated at 40 PSI
HFR-100-075-40-R	1" inlet x ¾" outlet, regulated at 40 PSI, reclaimed
133801	Reclaimed filter bonnet

HFR - FILTER REGULATOR KITS

Model	System Flow GPM	Required Pressure for 25 PSI Outlet
HFR-075-25	0.5	30
	2	30
	5	31
	10	33
	15	37
HFR-100-075-25	0.5	30
	2	30
	5	31
	10	32
	15	35

Model	System Flow GPM	Required Pressure for 40 PSI Outlet
HFR-075-40	0.5	45
	2	45
	5	46
	10	48
	15	54
HFR-100-075-40	0.5	45
	2	45
	5	46
	10	47
	15	52

With standard 150 mesh (100 microns) filter screen

FILTERS

For added durability, these simple yet rugged filters come standard with a stainless steel screen.

¾" AND 1" FILTER KEY BENEFITS

- Standard size of 150 mesh to collect debris and prevent system from clogging
- High-quality stainless steel screen
- Operating pressure: Up to 120 PSI

1½" AND 2" FILTER KEY BENEFITS

- Glass-filled polypropylene for added strength and durability
- Operating pressure: Up to 150 PSI
- Standard stainless steel screen: 150 mesh (100 microns)
- Large filtration screen provides longer life between cleanings
- Optional filter screens: 80 mesh (180 microns); 120 mesh (125 microns); SS
- Disc filter available: 120 mesh (125 microns)
- Warranty period: 2 years
- See page 206 for pressure loss charts

HUNTER Y-FILTERS AND SCREENS		
Size	Model	Description
¾" and 1"	HY-075	¾" inlet/outlet
	HY-100-075	1" inlet x ¾" outlet
	HY-100	1" inlet/outlet
	HY-100-R	1" inlet/outlet, with reclaimed bonnet
1½"	HY-151	1½" inlet/outlet
	HY-151-D	1½" disc filter with 120 mesh
	HY-151-SCREEN-150	150 mesh screen for 1½" filter
	HY-151-SCREEN-120	120 mesh screen for 1½" filter
	HY-151-SCREEN-080	80 mesh screen for 1½" filter
	HY-151-DISC-120	120 mesh disc for 1½" filter
2"	HY-201	2" inlet/outlet
	HY-201-D	2" disc filter with 120 mesh
	HY-201-SCREEN-150	150 mesh screen for 2" filter
	HY-201-SCREEN-120	120 mesh screen for 2" filter
	HY-201-SCREEN-080	80 mesh screen for 2" filter
	HY-201-DISC-120	120 mesh disc for 2" filter



Blue
80 mesh



Red
120 mesh



Black
150 mesh



Disc
120 mesh



HY-075, HY-100, HY-100-075

Height: 6"
Width: 3"
Length: 5"



HY-100-R

Height: 6"
Width: 3"
Length: 5"



HY-151

Height: 9"
Width: 5"
Length: 9"



HY-201

Height: 12"
Width: 6¾"
Length: 11½"

SENNINGER® PRESSURE REGULATORS

Choose the most consistent and reliable pressure regulators in the industry.

KEY BENEFITS

- Maintains consistent preset outlet pressure to prevent damage to system components
- 100% water-tested to ensure accuracy and dependable operation
- Install above or below ground for project design convenience
- Tamper-proof construction provides reliability and long life
- Very low hysteresis and friction loss help maintain accurate regulation
- No external metal parts for excellent corrosion resistance

OPERATING SPECIFICATIONS

- PRL (¾"):
 - Flow range: 0.5 to 8.0 GPM
 - Maximum inlet pressure*: 100 to 120 PSI
- PMR-MF (¾", 1"):
 - Flow range: 2 to 20 GPM
 - Maximum inlet pressure*: 100 to 130 PSI
- PRLG (¾"):
 - Flow range: 0.5 to 7.0 GPM
 - Maximum inlet pressure*: 100 to 120 PSI
- PRU:
 - Flow range: 20 to 100 GPM
 - Maximum inlet pressure*: 120 PSI
- Warranty period: 2 years

*Maximum recommended inlet pressure should not exceed 80 PSI above nominal model pressure

PRL (¾")			
Model	Pressure	Inlet	Outlet
PRL203F3F	20 PSI	¾"	¾"
PRL253F3F	25 PSI	¾"	¾"
PRL303F3F	30 PSI	¾"	¾"
PRL353F3F	35 PSI	¾"	¾"

PRLG (¾")			
Model	Pressure	Inlet	Outlet
PRLG253FH3MH	25 PSI	¾"	¾"

PRU40 (2")			
Model	Pressure	Inlet	Outlet
PRU-40	40 PSI	2"	2"

PMR-MF (¾")			
Model	Pressure	Inlet	Outlet
PMR20MF3F3FV	20 PSI	¾"	¾"
PMR25MF3F3FV	25 PSI	¾"	¾"
PMR30MF3F3FV	30 PSI	¾"	¾"
PMR35MF3F3FV	35 PSI	¾"	¾"
PMR40MF3F3FV	40 PSI	¾"	¾"
PMR50MF3F3FV	50 PSI	¾"	¾"

PMR-MF (1")			
Model	Pressure	Inlet	Outlet
PMR20MF4F4FV	20 PSI	1"	1"
PMR25MF4F4FV	25 PSI	1"	1"
PMR30MF4F4FV	30 PSI	1"	1"
PMR40MF4F4FV	40 PSI	1"	1"



PRL Pressure Regulator

Low-Flow
Width: 2"
Length: 4½"
Inlet/outlet: ¾"



PRLG Pressure Regulator

Landscape-Grade
Width: 1½"
Length: 3"
Inlet: ¾" FHT x Outlet: ¾" MHT



PRU Pressure Regulator Ultra

Width: 4½"
Length: 9"
Inlet/outlet: 2"



PMR-MF Pressure-Master Regulator

Medium-Flow
Width: 2½"
Length: 5½" (¾" model); 5¾" (1" model)
Inlet/outlet: ¾" or 1"

The pressure regulator will maintain the predetermined operating pressure, provided that the inlet pressure is at least 5 PSI above the expected outlet pressure, but not exceeding the maximum operating pressure.

DRIPLINE SYSTEMS

Ultra-durable Hunter Dripline (HDL) is easy to install and provides maximum longevity in the field. HDL works efficiently and effectively to use as little water as possible and keep plants thriving.

1 The dripline grid is a common installation practice either at grade or subsurface. Establishing consistent laterals in dense plantings provides a quick and simple approach to irrigating a planted area.

2 Arranging the dripline through a series of plants is an accepted and reliable method of irrigation. Ensure the dripline has emission points near or around each plant.

A Multi-Purpose Box:

- 10" x 7" opening
- Five color options for lids

B Control Zone Kit:

- Factory-assembled for quick and easy installation
- Low-, medium-, and high-flow kits

C HDL:

- All versions are pressure-compensating
- Colored stripes indicate flow
- Stretch-wrapped coils make installation simple and clean
- Four dripline options to choose from: HDL-CV, HDL-PC, HDL-R, HDL-COP

D Fittings:

- Double-barb holds fittings tight
- LOC Fittings can be reused

E Air/Vacuum Relief Valve:

- Helps prevent water hammer and tubing collapse
- Use at high point(s) in zone

F Eco-Indicator:

- Pops up at 12 PSI and shows system is running
- Reveals when system pressure drops too low

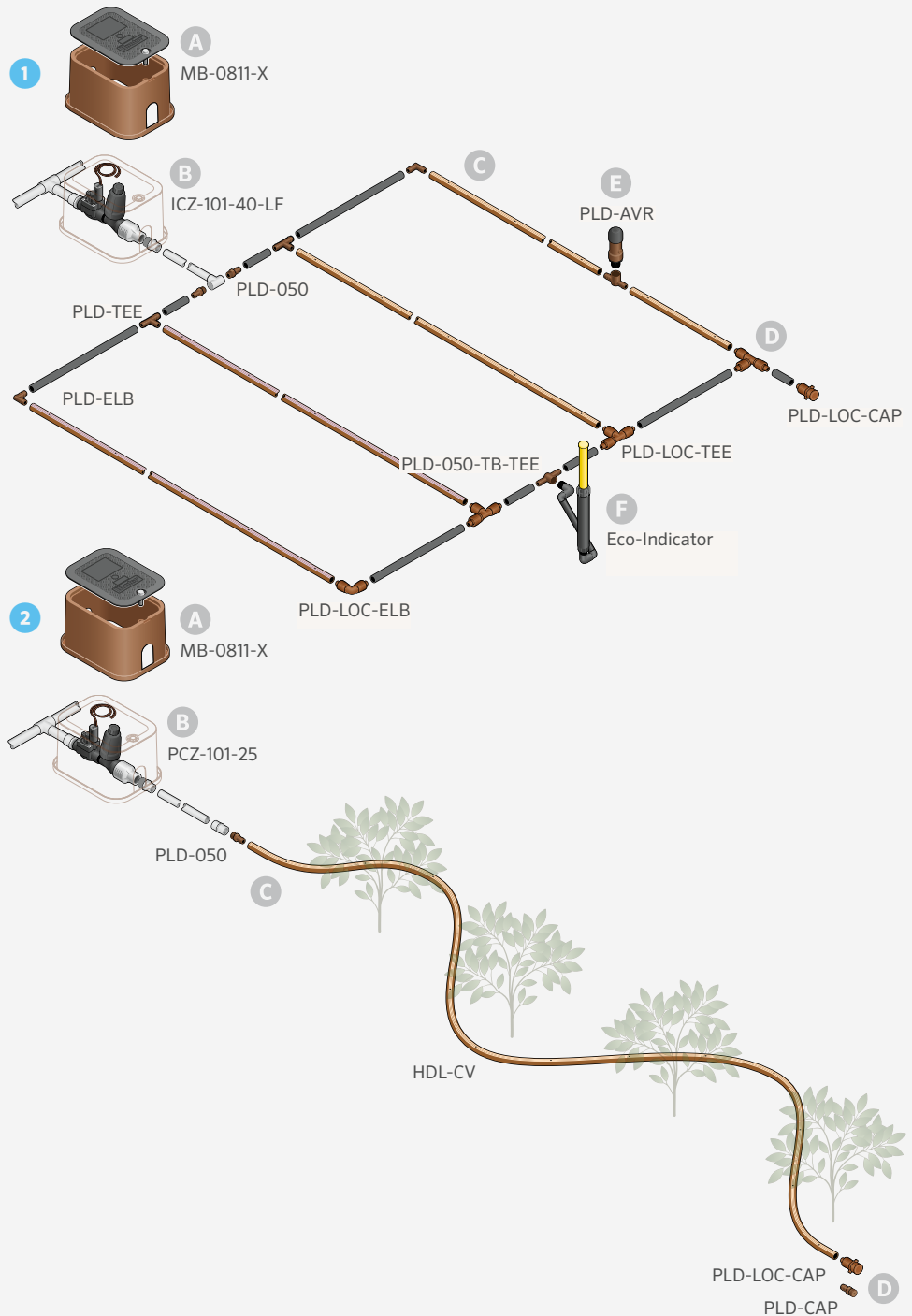

HDL-CV

Increase drip system efficiency with pressure compensation, flow indication stripes, and a 6' check height.

KEY BENEFITS

- Pressure-compensating emitters for consistent flow and uniform coverage
- Non-draining check valve (CV) prevents low-point pooling and allows all emitters to open/close at the same time for greater system efficiency
- Check height of 6' minimizes system drainage and runoff
- Anti-siphon feature prevents debris from entering emitter at system shutdown
- Color-coded stripes provide easy identification of flow
- UV resistance facilitates product longevity
- Stretch-wrapped coils stay intact and make installation quick and easy
- Superior grit tolerance provided by proprietary emitter design with multiple inlet filters, a wide turbulent labyrinth, and a full-size outlet pool

PRODUCT SPECIFICATIONS

- Available flow rates: 0.4, 0.6, 0.9 GPH
- Available emitter spacing: 12", 18", 24"
- Tubing dimensions: 0.660" x 0.560" (outside/inside diameter)
- Wall thickness: 0.049"

OPERATING SPECIFICATIONS

- Operating range: 15 to 60 PSI
- Minimum filtration: 120 mesh (125 microns)
- Warranty period: 5 years (plus 2 additional years for environmental stress cracking)



HDL-CV



Coil with Stretch Wrap

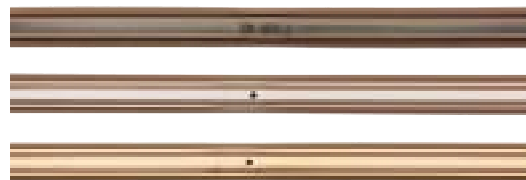

HUNTER DRIPLINE COLOR CODE

- | | |
|---------------------|----------------------------------------------------------------------|
| STRIPE COLOR | TUBING COLOR |
| ● 0.9 GPH - Black | ● HDL-CV - Dark brown tubing, pressure-compensating with check valve |
| ○ 0.6 GPH - Gray | |
| ○ 0.4 GPH - Tan | |

See **page 194** for Maximum Run Length Chart.

HDL-CV				
Model	Flow	Spacing	Length	
HDL-04-12-250-CV	0.4 GPH	12"	250'	
HDL-04-12-1K-CV			1,000'	
HDL-04-18-250-CV		18"	250'	
HDL-04-18-1K-CV	1,000'			
HDL-06-12-100-CV	0.6 GPH	12"	100'	
HDL-06-12-250-CV			250'	
HDL-06-12-500-CV			500'	
HDL-06-12-1K-CV		1,000'		
HDL-06-18-250-CV			18"	250'
HDL-06-18-1K-CV				1,000'
HDL-06-24-250-CV	24"	250'		
HDL-09-12-100-CV	0.9 GPH	12"	100'	
HDL-09-12-250-CV			250'	
HDL-09-12-500-CV			500'	
HDL-09-12-1K-CV		1,000'		
HDL-09-18-250-CV			18"	250'
HDL-09-18-1K-CV				1,000'
HDL-09-24-250-CV		24"	250'	

Compatible with:



Soil-Clik® Sensor
Page 141



Eco-Indicator
Page 168

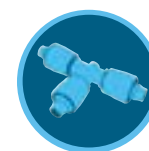

PLD Fittings
Page 164

HDL-PC & HDL-R

Maximize drip system longevity with robust material construction and pressure compensation for standard and reclaimed applications.

KEY BENEFITS

- Pressure-compensating emitters for consistent flow and uniform coverage
- Color-coded stripes provide easy identification of flow
- UV resistance facilitates product longevity
- Stretch-wrapped coils stay intact and make installation quick and easy
- Superior grit tolerance provided by proprietary emitter design with multiple inlet filters, a wide turbulent labyrinth, and a full-size outlet pool
- Reclaimed product (HDL-R) identified by purple stripes assists in visual identification when using non-potable water

PRODUCT SPECIFICATIONS

- Available flow rates: 0.6, 0.9 GPH
- Available emitter spacing: 12", 18"
- Tubing dimensions: 0.660" x 0.560" (outside/inside diameter)
- Wall thickness: 0.049"

OPERATING SPECIFICATIONS

- Operating range: 10 to 60 PSI
- Minimum filtration: 120 mesh (125 microns)
- Warranty period: 5 years (plus 2 additional years for environmental stress cracking)



HDL-PC



HDL-R (Reclaimed)

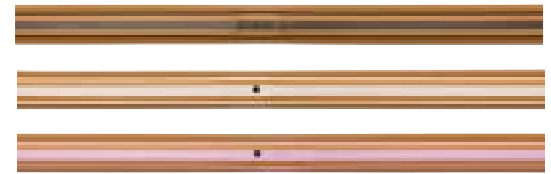

HUNTER DRIPLINE COLOR CODE

STRIPE COLOR

- 0.9 GPH - Black
- 0.6 GPH - Gray
- Reclaimed - Purple

TUBING COLOR

- HDL-PC - Light brown tubing pressure-compensating
- HDL-R - Light brown with purple stripe, pressure-compensating, reclaimed

See page 194 for Maximum Run Length Charts.

HDL-PC			
Model	Flow	Spacing	Length
HDL-06-12-250-PC	0.6 GPH	12"	250'
HDL-06-12-500-PC			500'
HDL-06-18-250-PC		18"	250'
HDL-09-12-250-PC	0.9 GPH	12"	250'
HDL-09-12-500-PC			500'
HDL-09-18-250-PC		18"	250'

HDL-R			
Model	Flow	Spacing	Length
HDL-06-12-250-R	0.6 GPH	12"	250'
HDL-06-12-1K-R			1,000'
HDL-06-18-250-R		18"	250'
HDL-06-18-1K-R			1,000'
HDL-09-12-250-R	0.9 GPH	12"	250'
HDL-09-12-1K-R			1,000'
HDL-09-18-250-R		18"	250'
HDL-09-18-1K-R			1,000'

Compatible with:

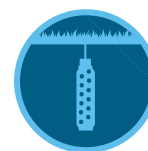

Soil-Clik
Page 141



Eco-Indicator
Page 168



PLD Fittings
Page 164

HDL-BLNK

UV-resistant HDL Blank Tubing is a useful addition to any drip system.

KEY BENEFITS

- UV resistance facilitates product longevity
- Stretch-wrapped coils stay intact and make installation quick and easy
- Accepts Hunter PLD-LOC and 17 mm barb fittings for ease of connection
- Earth-tone tubing prevents bright spots in the landscape
- Purple stripes for reclaimed applications

PRODUCT SPECIFICATIONS

- Tubing dimensions: 0.660" x 0.560" (outside/inside diameter)
- Wall thickness: 0.049"

OPERATING SPECIFICATIONS

- Operating range: Up to 60 PSI
- Warranty period: 5 years (plus 2 additional years for environmental stress cracking)



HDL-BLNK



HDL-BLNK-R

HDL-BLNK			
Model	Flow	Spacing	Length
HDL-BLNK-100	Blank tubing		100'
HDL-BLNK-250			250'
HDL-BLNK-500			500'
HDL-BLNK-1K			1,000'
HDL-BLNK-500-R	Blank tubing (reclaimed)		500'

Compatible with:



Soil-Clik® Sensor
Page 141



Eco-Indicator
Page 168



PLD Fittings
Page 164

HDL-COP

Minimize the risk of root intrusion by adding copper to industry-leading Hunter Dripline.

KEY BENEFITS

- Emitters infused with copper oxide (Cu₂O) provide triple protection against root intrusion
- Long-term, safe, and non-leaching solution
- Slow-draining check valve (CV) emitters prevent low-point pooling and boost system efficiency
- Pressure-compensating emitters provide consistent flow over the entire lateral length
- Anti-siphon feature prevents debris from entering emitters
- Color-coded stripes provide easy flow identification
- UV resistance facilitates product longevity
- Stretch-wrapped coils stay intact and make installation quick and easy
- Multiple inlet filters in the emitter and a wide turbulent labyrinth provide superior grit tolerance
- Full-sized emitter outlet pool and raised wall keep debris and roots from entering the emitter

PRODUCT SPECIFICATIONS

- Emitter spacing: 12", 18"
- Tubing dimensions: 0.660" x 0.560" (outside/inside diameter)
- Wall thickness: 0.049"
- Diaphragm: Silicone

OPERATING SPECIFICATIONS

- Available flow rates: 0.6, 0.9 GPH
- Operating range: 15 to 60 PSI
- Recommended minimum filtration: 120 mesh
- Warranty period: 5 years (plus 2 additional years for environmental stress cracking)
- No warranty against root intrusion

HDL-COP			
Model	Flow	Spacing	Length
HDL-06-12-250-COP	0.6 GPH	12"	250'
HDL-06-12-1K-COP			1,000'
HDL-06-18-250-COP	0.9 GPH	18"	250'
HDL-09-12-250-COP		12"	250'
HDL-09-12-1K-COP			1,000'
HDL-09-18-250-COP		18"	250'

Note: While the use of copper does not completely remove the chance of root intrusion, it has been shown to assist in its prevention when coupled with proper irrigation scheduling.



HDL-COP



Coil with Stretch Wrap



HUNTER DRIPLINE COLOR CODES

STRIPE COLOR

- 0.6 GPH - Gray
- 0.9 GPH - Black

TUBING COLOR

- HDL-COP - Pressure-compensating, earth-tone copper tubing with slow-draining check valve

See [page 194](#) for Maximum Run Length Charts.

Compatible with:



Soil-Clik
Page 141



Eco-Indicator
Page 168

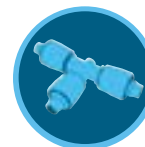

PLD Fittings
Page 164

PLD LOC FITTINGS (16-18 MM)

LOC Fittings are compatible with any nominal 1/2" tubing and dripline for quicker installs and easy repairs.

KEY BENEFITS

- Glass-filled polypropylene for added durability
- Thread lock connection method provides a secure connection while still allowing flexibility for service and system changes

PRODUCT SPECIFICATIONS

- Use with HDL, TWPE, or other 16/17/18 mm dripline or tubing

OPERATING SPECIFICATIONS

- Operating pressure range: up to 145 PSI
- Warranty period: 2 years

FITTINGS



PLD-LOC 075
3/4" male pipe thread x LOC



PLD-LOC 050
1/2" male pipe thread x LOC



PLD-LOC CAP
End cap x LOC



PLD-LOC ELB
Locking elbow



PLD-LOC CPL
Locking coupler



PLD-LOC FHS
3/4" female hose swivel x LOC



PLD-LOC TEE
Locking tee

PLD BARB FITTINGS (17 MM)

Acetal construction holds vinyl and PE tubing for an ideal low-cost choice when installing dripline.

KEY BENEFITS

- Acetal material provides a secure connection
- Dual barb removes the need for clamps

PRODUCT SPECIFICATIONS

- Use with HDL or other 17 mm dripline
- For installations with PLD-IAC/PLD-IAE grommets, use an 1/16" spade drill bit to cut into the PVC

OPERATING SPECIFICATIONS

- Operating pressure range: up to 100 PSI
- Warranty period: 1 year

FITTINGS



PLD-050
1/2" MPT x 17 mm barb



PLD-ELB
17 mm barb elbow



PLD-075
3/4" MPT x 17 mm barb



PLD-CPL
17 mm barb coupling



PLD-CAP
17 mm barb x 1/2" MPT with cap



PLD-075-TB-TEE
17 mm barb tee x 3/4" thread



PLD-BV
17 mm barb Shut-off valve



PLD-TEE
17 mm barb tee



PLD-050-TB-TEE
1/2" FPT x 17 mm barb tee



PLD-IAC
(with grommet)
Insert adapter x 17 mm coupling



PLD-IAE
(with grommet)
Insert adapter x 17 mm elbow



PLD-CRS
17 mm barb cross



PLD-075-TB-ELB
3/4" FPT x 17 mm barb elbow

SUBSURFACE SYSTEMS

Subsurface drip irrigation systems can be extremely effective at saving water and encouraging root growth. Hunter is the only manufacturer to offer three tiers of top-quality subsurface irrigation solutions: HDL-COP Dripline, the Eco-Wrap® System, and the Eco-Mat® System.

1 Eco-Mat offers 30% greater efficiency than any other bare subsurface dripline product. It installs under the soil like a blanket of water, ready for the roots to absorb what they need.

2 Eco-Wrap provides resistance to root intrusion while enhancing the capillary action and efficiency of the system. Eco-Wrap combines the quality of HDL with the wicking properties of polyethylene fleece.

A **Entry Manifold:**

- PVC (for stability) or polyethylene
- Assemble with either 17 mm or LOC Fittings

B **Multi-Purpose Box:**

- 10" x 7" opening
- Five color options for lids

C **Control Zone Kit:**

- Factory-assembled for quick and easy installation
- Low-, medium-, and high-flow kits

D **Air/Vacuum Relief Valve:**

- Helps prevent water hammer and tubing collapse
- Use at high point(s) in zone

E **Eco-Indicator Tool:**

- Pops up at 12 PSI and shows system is running
- Reveals when system pressure drops too low

F **Fittings:**

- Double-barb holds fittings tight
- LOC Fittings can be reused

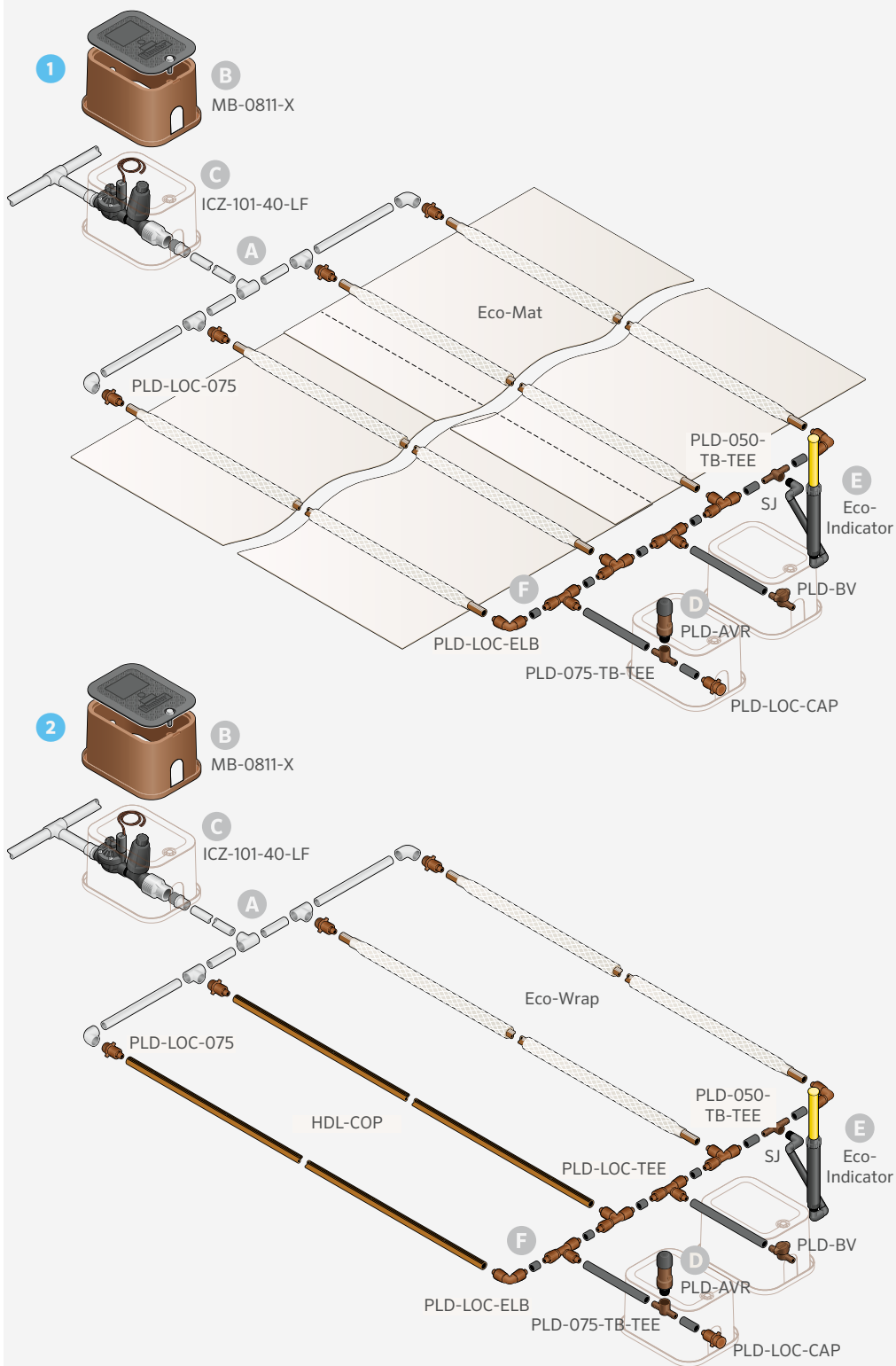

ECO-MAT®

Irrigate plants below the root zone for maximum efficiency with a combination of fleece-wrapped dripline and fleece blanket.

KEY BENEFITS

- Anti-siphon feature and fleece wrap protect against debris and root intrusion
- Saves 20% to 40% more water than standard products due to superior capillary movement of water to the entire root zone, promoting healthier root growth
- Non-draining, pressure-compensating emitters open/close simultaneously, maximizing efficiency
- Check height of 6' minimizes system drainage and runoff

OPERATING SPECIFICATIONS

- Operating range: 15 to 50 PSI
- Minimum filtration: 120 mesh
- Compatible with LOC and 17 mm insert barb fittings
- Air relief recommended for sloping conditions greater than 6'
- Recommended installation depth: turf (4" to 6"); other (4" to 14")
- May use in conjunction with Eco-Wrap® System
- Warranty period: 5 years (plus 2 additional years for environmental stress cracking)

PRODUCT SPECIFICATIONS

- Flow rate: 0.6 GPH; 0.83 in/hr
- Emitter spacing: 12"
- Lateral row spacing: 14"
- Product width: 32"
- Roll length: Mini roll = 100'; standard roll = 295'
- Tubing dimensions: 0.660" x 0.560" (outside/inside diameter)
- Water-holding capacity: 0.5 gallons
- Approximate coverage per roll: Mini roll = 250 ft²; Standard roll = 737 ft²
- Example calculation based on area 40' x 80':

$$\text{Qty.} = \frac{\text{Irrigated landscape area}}{\text{Area of roll coverage}} = \frac{3,200 \text{ ft}^2}{737 \text{ ft}^2} = 4.34 \text{ (round up to 5 rolls)}$$

ECO-MAT			
Model	Pressure	Inlet	Outlet
ECO-MAT			Subsurface drip mat, 32" wide, 295' long, 17 mm dripline
ECO-MAT-17-100			Subsurface drip mat, 32" wide, 100' long, 17 mm dripline

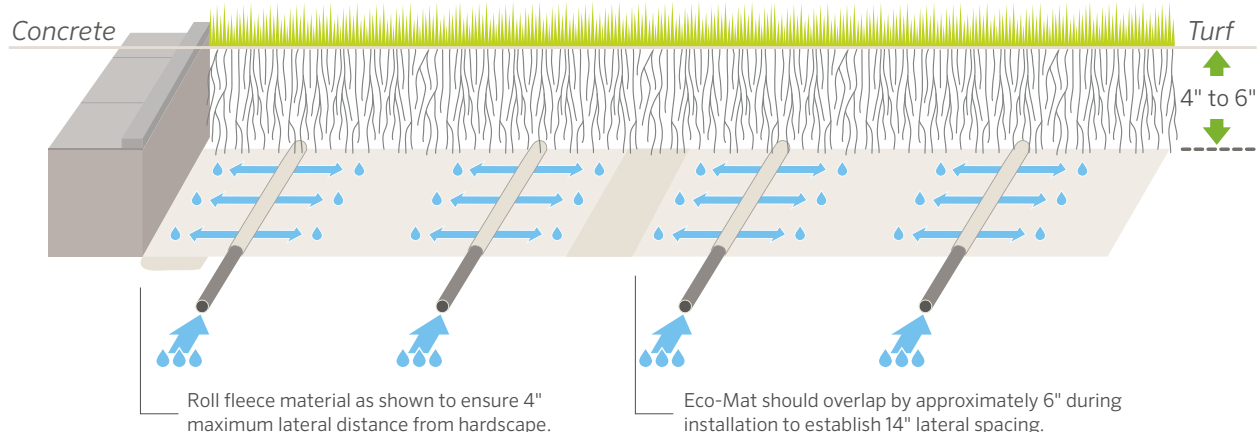

Eco-Mat

Eco-Mat Installed



Compatible with:

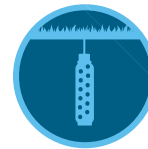

Soil-Clik® Sensor
Page 141



Eco-Indicator
Page 168

ECO-WRAP®

Irrigate more efficiently than blank dripline with fleece-wrapped dripline.

KEY BENEFITS

- Perfect for narrow areas that are difficult to irrigate with standard methods
- Anti-siphon feature and fleece wrap protect against debris and root intrusion
- Saves 20–40% more water than standard products due to superior capillary movement of water to the entire root zone, promoting healthier root growth
- Non-draining, pressure-compensating emitters open/close simultaneously, maximizing efficiency
- Check height of 6' minimizes system drainage and runoff

OPERATING SPECIFICATIONS

- Flow rate: 0.6 GPH
- Emitter spacing: 12"
- Tubing dimensions: 0.660" x 0.560" (outside/inside diameter)
- Roll length: 250'
- Accepts 17 mm barb or LOC Fittings
- Warranty period: 5 years (plus 2 additional years for environmental stress cracking)

PRODUCT SPECIFICATIONS

- Operating range: 15 to 50 PSI
- Minimum filtration: 120 mesh
- Air relief recommended for sloping conditions greater than 6'
- Recommended installation depth: turf (4" to 6"); other (4" to 8")
- Compatible with Eco-Mat® System

ECO-WRAP	
Model	Description
ECO-WRAP-17	HDL-CV with subsurface fleece sleeve

MAXIMUM RUN LENGTH FOR ECO-MAT AND ECO-WRAP	
Pressure (PSI)	Length (ft)
15	171
20	239
25	280
30	314
40	363
50	404
60	438



Eco-Wrap

For maximum run lengths, reference the Maximum Run Length Chart on page 160. Use 0.6 GPH for flow and 12" emitter spacing.

Eco-Wrap Installed



Compatible with:



Soil-Clik
Page 141



Eco-Indicator
Page 168

ECO-INDICATOR

Confirm system operation and adequate pressure with this handy visual device.

KEY BENEFITS

- Visible bright yellow or reclaimed purple riser stem and cap indicate when system is in operation
- Stem pops up when pressure exceeds the threshold and assists in confirming low pressures if not raised
- Connects via bottom or side inlet ports for easy installation; side inlet port is available on 12" version

OPERATING SPECIFICATIONS

- ECO-ID:
 - Operating pressure: up to 70 PSI
 - Indication of system operation: above 12 PSI
 - Warranty period: 2 years
- ECO-ID-12, ECO-ID-12-R:
 - Operating pressure: up to 100 PSI
 - Indication of system operation: above 15 PSI
 - Warranty period: 5 years

USER-INSTALLED OPTIONS FOR 12" ECO-INDICATOR

- Drain check valve (up to 10' of elevation; P/N 437400SP)
- SJ Swing Joint: SJ-512 (½" threaded x 12" length)

ECO-INDICATOR	
Model	Description
ECO-ID	6" Eco-Indicator
ECO-ID-12	12" Eco-Indicator
ECO-ID-12-R	12" Eco-Indicator, Reclaimed

Eco-Indicator Installed



ECO-ID

Retracted height: 9½"
 Pop-up height: 6"
 Exposed diameter: 1¼"
 Inlet size: ½"



[A] ECO-ID-12

[B] ECO-ID-12-R
 Retracted height: 16½"
 Pop-up height: 12"
 Exposed diameter: 2¼"
 Inlet size: ½"

Compatible with:

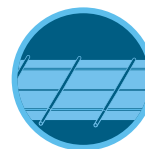

Eco-Mat®
 System
 Page 166

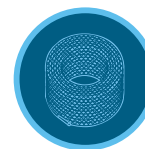

Eco-Wrap®
 System
 Page 167

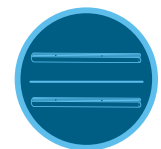

HDL Dripline
 Page 160

SUPPLY TUBING

UV-resistant polyethylene makes this 0.700" x 0.600" solution a useful addition to drip systems.

KEY BENEFITS

- Thick wall and UV resistance provide durability and longevity
- Kink resistance for added flexibility and quicker installation

PRODUCT SPECIFICATIONS

- 0.700" x 0.600" (outside/inside diameter)

OPERATING SPECIFICATIONS

- Operating pressure range: Up to 80 PSI
- Warranty period: 2 years



1/2" PE Tubing

1/2" PE TUBING – SPECIFICATION BUILDER: ORDER 1 + 2 + 3

1 Model	2 Tubing Diameter	3 Length
TWPE = Thick-walled polyethylene tubing	700 = 0.700" outside diameter	100 = 100' 250 = 250' 500 = 500'

Example:

TWPE-700-250 = 1/2" polyethylene tubing in a 250' roll

MLD

Use this 1/4" dripline solution for tight spaces and raised planters.

KEY BENEFITS

- Superior flexibility makes MLD an excellent choice for small spaces and raised containers
- Properly irrigates without being intrusive to the landscape

PRODUCT SPECIFICATIONS

- Colors: brown or black polyethylene
- Emitter spacing: 6" or 12"
- Coil size: 100'
- 0.250" x 0.175" (outside/inside diameter)
- Use with 1/4" barb fittings

OPERATING SPECIFICATIONS

- Pressure range: 10 to 40 PSI
- Minimum filtration: 150 mesh
- Maximum run lengths: 6" spacing = 15'; 12" spacing = 30'
- Warranty period: 2 years

MLD – SPECIFICATION BUILDER: ORDER 1 + 2 + 3 + 4

1 Model	2 Spacing	3 Length	4 Options
MLD-05	06 = 6" 12 = 12"	100 = 100'	BL = Black (blank) = Brown

Example:

MLD-05-12-100 = 0.5 GPH mini landscape dripline with 12" spacing in a 100' roll, brown



MLD

MLD Installed



DISTRIBUTION TUBING

Add stability and flexibility to any system when using Point-Source Emitters or Micro Sprays.

KEY BENEFITS

- High-quality vinyl or polyethylene securely connects to acetal ¼" fittings
- Vinyl is more flexible, but it softens in high heat and should be used in cooler climates
- Polyethylene performs well in warmer climates

PRODUCT SPECIFICATIONS

- Material: Polyethylene or vinyl
- Coil sizes: 100', 250', and 1,000'

OPERATING SPECIFICATIONS

- Operating pressure range: Up to 60 PSI
- Warranty period: 2 years



¼" Tubing

¼" TUBING - SPECIFICATION BUILDER: ORDER 1 + 2 + 3

1	Model	2	Tubing Diameter	3	Length
	HQPE = Polyethylene tubing		250 = 0.250" outside diameter		100 = 100'
	HQV = Vinyl tubing				250 = 250'
					1K = 1,000'

Example:

HQPE-250-1K = ¼" polyethylene tubing in a 1,000' roll

¼" BARBED FITTINGS

Ensure a superior hold with robust acetal construction.

KEY BENEFITS

- Acetal material provides a secure connection
- Goof plug lays flat to help prevent leaking

PRODUCT SPECIFICATIONS

- Fits Hunter MLD and Distribution Tubing

OPERATING SPECIFICATIONS

- Pressure range: Up to 60 PSI
- Warranty period: 1 year



QB-TEE
¼" barb tee



QB-ELB
¼" barb elbow



QB-CPL
¼" barb coupling



QB-CRS
¼" barb cross



GP-025
Goof plug

¼" Barb Fittings:

Use with MLD or any vinyl or polyethylene ¼" tubing, UV-stabilized materials, and durable single-barb connection

RZWS

Deliver water across all levels of the root zone for high-efficiency subsurface irrigation of trees and shrubs.

KEY BENEFITS

- Patented StrataRoot™ Baffle System diverts water to all levels of the root zone while adding strength to the unit
- Durable locking cap for vandal resistance
- Pressure-compensating bubbler for accurate water flow
- Built-in Hunter Swing Joint for direct installation to ½" PVC fitting
- Preassembled for fast installation

OPERATING SPECIFICATIONS

- Bubbler flow rates: 0.25 or 0.50 GPM
- Recommended pressure range: 15 to 70 PSI
- Warranty period: 2 years

FACTORY-INSTALLED OPTIONS

- Check valve (HCV)
- Locking reclaimed water purple cap

USER-INSTALLED OPTIONS

- Fabric sleeve to prevent soil intrusion in sandy areas for 18" and 36" models (P/N RZWS-SLEEVE)
- Replacement cap for 18" and 36" models (P/N 913300SP)
- Locking reclaimed purple cap for 18" and 36" models (P/N 913301SP)
- Reclaimed water purple cap for 10" model (P/N RZWS10-RCC)



RZWS-10

Tube diameter: 2"
Cap diameter: 3"
Length: 10"

RZWS-18

Tube diameter: 3"
Cap diameter: 4¾"
Length: 18"

RZWS-36

Tube diameter: 3"
Cap diameter: 4¾"
Length: 36"



Reclaimed models available
(Add **-R** to model number)

ROOT ZONE WATERING SYSTEM – SPECIFICATION BUILDER: Order 1 + 2 + 3

1	Model	2	Bubbler Flow Rate	3	Options
	RZWS-10 = 10" Root Zone Watering System	25 = 0.25 GPM		(blank) = No option	
	RZWS-18 = 18" Root Zone Watering System	50 = 0.50 GPM		CV = Check valve	
	RZWS-36 = 36" Root Zone Watering System	(blank) = No bubbler or swing joint		R = Reclaimed cap	
				CV-R = Check valve with reclaimed cap	

Examples:

RZWS-10-50-CV = 10" Root Zone Watering System at 0.50 GPM, with check valve
RZWS-36-25-CV-R = 36" Root Zone Watering System at 0.25 GPM, with check valve and reclaimed cap

ADDITIONAL OPTION (SPECIFY SEPARATELY)

RZWS-SLEEVE = Field-installed sleeve made from filter fabric

SOFT PIPE SYSTEMS

Using soft pipe to distribute irrigation water is acceptable in both commercial and residential applications. Polyethylene tubing is used in place of PVC and may be 1", ¾", or ½". Hunter offers a full suite of products that are compatible with soft pipe systems.

1 Tree and Shrub Rings:

- Convenient and efficient way to irrigate sparse plantings
- Use HDL or MLD to form the irrigation ring
- Connect with LOC Fittings for faster installation

2 ½" and ¼" Tubing:

- Use ½" polyethylene (TWPE) to distribute water
- Use ¼" PE (HQPE) or vinyl (HQV) to connect to emitters and Micro Sprays

3 Point-Source Emitters:

- Barbed emitters insert directly into PE tubing or at the end of ¼" vinyl/PE
- Color-coded flows (0.5, 1.0, 2.0, 4.0, 6.0 GPH)

4 Micro Spray Stakes:

- Use when higher flows are needed (0-30 GPH)
- Throw water from 0' to 12'

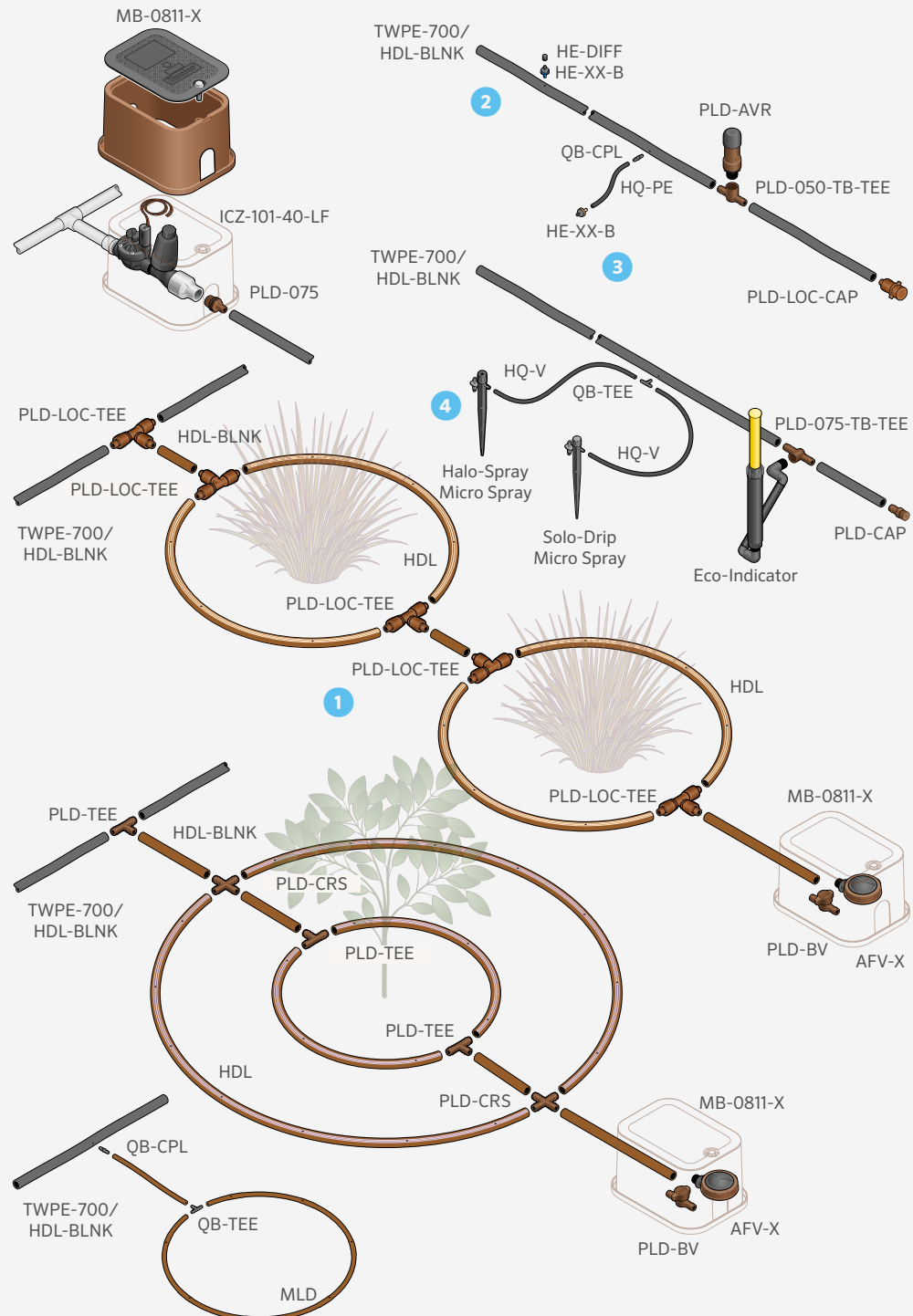

HARD PIPE SYSTEMS

From Multi-Port Emitters to Micro Sprays, Hunter offers a wide variety of products and accessories that are designed to complement hard pipe systems.

1 IH Risers:

- Ultra-durable, point-to-point emitters
- Built-in check valve screen makes them great for slopes
- Wide variety of flows

2 Point-Source Emitters:

- Color-coded flows (0.5, 1.0, 2.0, 4.0, 6.0 GPH)
- HEB (1/2" threaded emitter bubblers install directly onto 1/2" risers)
- HE-T (10-32 threaded emitters install onto rigid risers)

3 Multi-Port Emitters:

- Color-coded flows (0.5, 1.0, 2.0 GPH)
- Swivel barbs for directional flow
- Install directly onto 1/2" risers

4 Micro Sprays:

- Ideal for higher flows (0 to 30 GPH)
- Diameter of throw from 0' to 12' Install directly onto rigid risers or on 1/4" tubing

5 Root Zone Watering System:

- For deep root irrigating
- Allows oxygen to penetrate the soil
- Encourages healthier root growth

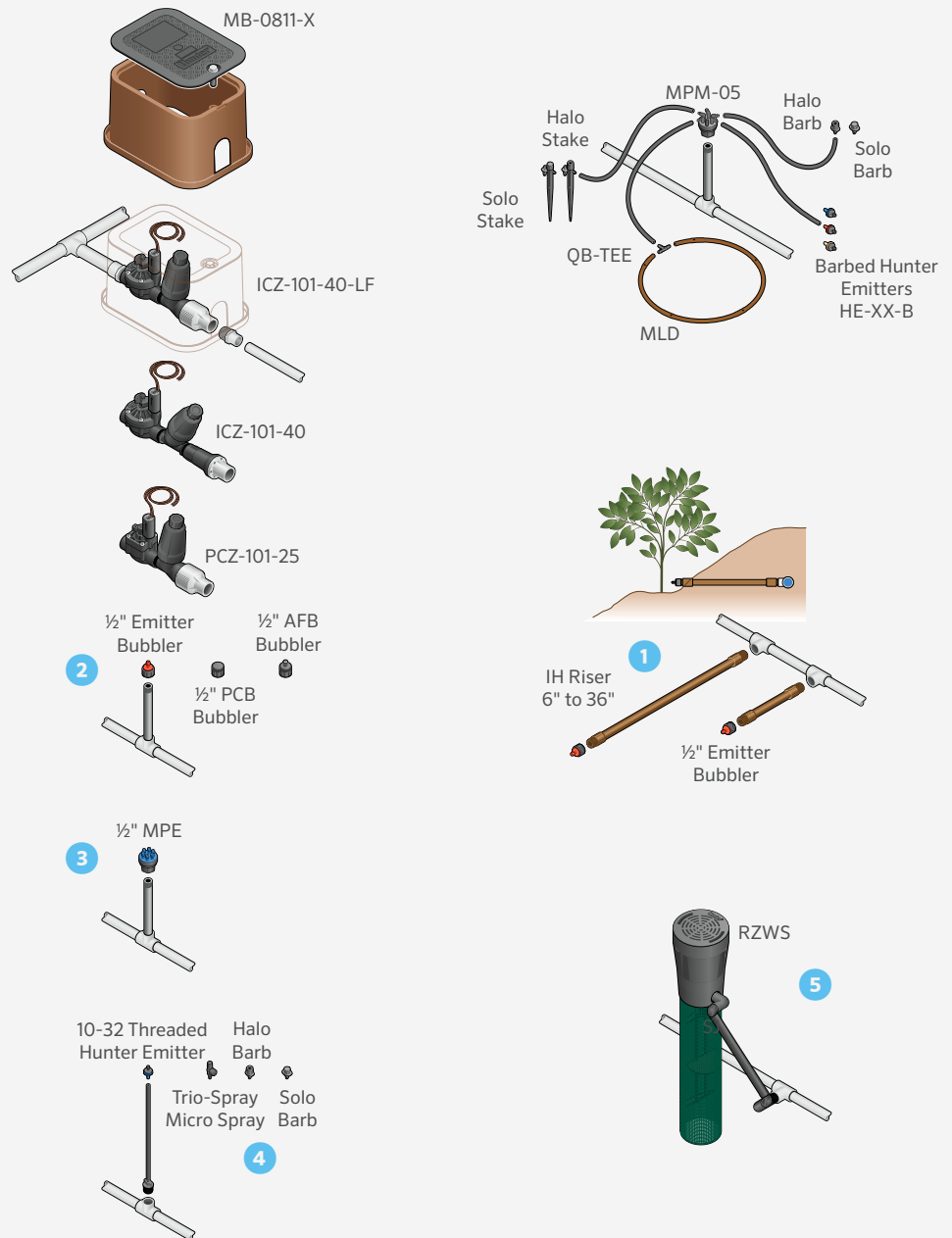

POINT-SOURCE EMITTERS

Ensure accurate irrigation for mixed and sparse plantings with a wide range of flow rates.

KEY BENEFITS

- Pressure-compensating for consistent and reliable flow
- Color-coded by flow for easy identification in the field
- Self-flushing diaphragm to prevent clogs
- Earth-tone colors blend in well with the surrounding environment
- Three inlet variations offer installation flexibility: ¼" barb, 10-32 thread, ½" FPT
- Coined edges for easy gripping
- Self-piercing barb for simple, no-tool installation
- Optional diffuser cap to gently distribute water at high flow

OPERATING SPECIFICATIONS

- Recommended pressure range: 20 to 50 PSI
- Minimum filtration: 150 mesh
- Warranty period: 2 years

½" FEMALE THREAD (BROWN BASE) WITH CHECK VALVE SCREEN			
	Model	Inlet Type	Flow (GPH)
● Blue	HEB-05-CV	½" female thread	0.5
● Black	HEB-10-CV	½" female thread	1.0
● Red	HEB-20-CV	½" female thread	2.0
● Tan	HEB-40-CV	½" female thread	4.0
● Orange	HEB-60-CV	½" female thread	6.0

EMITTER MODEL CHART			
	Model	Inlet Type	Flow (GPH)
● Blue	HE-050-B	Self-piercing barb	0.5
● Black	HE-10-B	Self-piercing barb	1.0
● Red	HE-20-B	Self-piercing barb	2.0
● Tan	HE-40-B	Self-piercing barb	4.0
● Orange	HE-60-B	Self-piercing barb	6.0
● Blue	HE-050-T	10-32 thread	0.5
● Black	HE-10-T	10-32 thread	1.0
● Red	HE-20-T	10-32 thread </td <td>2.0</td>	2.0
● Tan	HE-40-T	10-32 thread	4.0
● Orange	HE-60-T	10-32 thread	6.0
● Blue	HEB-05	½" female thread	0.5
● Black	HEB-10	½" female thread	1.0
● Red	HEB-20	½" female thread	2.0
● Tan	HEB-40	½" female thread	4.0
● Orange	HEB-60	½" female thread	6.0



DIFFUSER CAP

(HE-DIFF)

Use for flows higher than 2 GPH to diffuse the water and prevent erosion



½" FEMALE THREAD

Brown base matches IH Risers and blends into the landscape



SCREEN-CV

Filter screen with 12' check valve

Inlet Options

① Self-piercing barb



② 10-32 thread

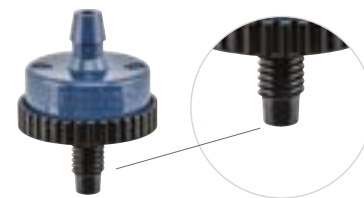

③ ½" female thread



IH RISERS

Simplify point-to-point irrigation with vandal-resistant, heavy-duty IH Risers.

KEY BENEFITS

- Heavy-duty, military-grade, vandal-resistant design
- Made of flexible PVC for durability
- Brown components blend in with the landscape
- Purple fittings available for reclaimed water applications
- Accepts any ½" FPT emitter
- Ideal for slope applications
- At-grade or below-grade installation
- Available in multiple lengths for easy assembly
- Available as components for custom lengths

OPERATING SPECIFICATIONS

- Maximum flow: 7 GPM
- Maximum pressure: 60 PSI
- Warranty period: 2 years

IH Risers – SPECIFICATION BUILDER: ORDER 1 + 2 + 3		
1 Model	2 Riser Length	3 Fitting Options
IH-RISER	06 = 6" riser 12 = 12" riser 18 = 18" riser 24 = 24" riser 36 = 36" riser	(blank) = Brown R = Reclaimed (purple fitting)

Example:
IH-RISER-12 = 12" flexible PVC riser with preglued ½" fittings

IH RISER COMPONENTS (SOLD SEPARATELY)	
Model	Description
SCREEN-CV	Filter screen with 12' check valve
IH-FIT-3850	¾" x ½" MPT IH fitting
IH-FIT-3850-R	¾" x ½" MPT IH fitting (reclaimed)
IH-250	Flexible PVC irrigation hose (0.50" ID x 0.090" wall), 250'

RECOMMENDED GLUES FOR FLEXIBLE PVC

- IPS® Weld-On®:
 - P-68™ primer (recommended for PVC fittings only)
 - P-70™ primer (may be, used but P-68 is suggested)
 - 795™ Flex PVC cement
- Christy's®:
 - Purple Primer® or Red Hot Clear Primer® (fittings only)
 - Flex Pro PVC pipe cement
 - Red Hot Blue Glue® (not specialized for flexible PVC)



IH RISERS



SCREEN-CV
Filter screen with 12' check valve



IH-FIT-3850, IH-FIT-3850-R
¾" x ½" MPT IH fitting



IH-250
Flexible PVC for creating headers or custom risers

Compatible with:



Point-Source Emitters
Page 174



Bubblers
Page 75



Multi-Port Emitters
Page 176

IPS, Weld-On, P-68, P-70, and 795 are trademarks of IPS Corporation. Christy's, Purple Primer, Red Hot Clear Primer, and Red Hot Blue Glue are trademarks of T. Christy Enterprises.

MULTI-PORT EMITTERS

Use these emitters to irrigate groups of plants effectively from one source.

KEY BENEFITS

- Six pressure-compensating emitter ports provide consistent and reliable flow
- Color-coded by flow for easy identification
- Earth-tone colors blend in with surrounding landscape
- Swivel elbows assist in placing water directly to plant
- Multi-Port Manifold (MPM) provides unrestricted flow for each outlet

PRODUCT SPECIFICATIONS

- Available in ½" FNPT
- Available flows: 0.5, 1.0, 2.0 GPH
- PVC cap plugs port when not being used

OPERATING SPECIFICATIONS

- Pressure range: 10 to 50 PSI
- Minimum filtration: 150 mesh
- Warranty period: 2 years

MULTI-PORT EMITTER MODEL CHART

	Model	Flow (GPH)
● Blue	MPE-05	0.5
● Black	MPE-10	1.0
● Red	MPE-20	2.0
● Gray	MPM-050	N/A



Multi-Port Emitter



Multi-Port Manifold

(MPM-050)

Unrestricted flow through outlets as indicated by gray color. Use with ¼" distribution tubing and a barbed emitter at the end (available in ½" FPT). Allows water to be directed to as many as six different locations.

Emitter Caps

(MPE-CAPS)

Plug unused ¼" barbed emitter outlets. Use with Hunter Multi-Port Emitters.



Hunter Emitter Multi-Tool

(HEMT)

Punches pilot holes and pellets, inserts and removes emitters, and cuts tubing.

MICRO SPRAYS

Apply water accurately for small-area coverage.

SOLO-DRIP

- Eight streams of water for thorough coverage
- Adjustable cap for flow and radius adjustment



SOLO-DRIP PERFORMANCE DATA			
Pressure PSI	Flow GPH	Throw Diameter ft	
15	0-11	0-1.5	
20	0-12.5	0-1.9	
30	0-15.7	0-2.7	

Note: Adjustable to maximum (approximately 20 clicks)

HALO-SPRAY

- Adjustable umbrella of water
- Adjustable cap for flow and radius adjustment



HALO-SPRAY PERFORMANCE DATA			
Pressure PSI	Flow GPH	Throw Diameter ft	
15	0-14	0-5.8	
20	0-16	0-7.7	
30	0-20	0-11.5	

Note: Adjustable to maximum (approximately 14 clicks)

TRIO-SPRAY

- Full-, half-, and quarter-circle configurations
- Adjustable cap for flow and radius adjustment



TRIO-SPRAY PERFORMANCE DATA				
Pressure PSI	Flow GPH	Spray Pattern ft.		
		Diameter in Throw 360° x 18 Hole	Radius of Throw 180°	90°
10	0-16.7	0-17	0-7	0-6
15	0-20.3	0-19	0-8	0-7
20	0-23.4	0-20	0-9	0-8
25	0-26.1	0-22	0-10	0-9
30	0-28.6	0-23	0-11	0-10



SD-T

HS-T

TS-T-F



SD-B

HS-B

TS-T-H



SD-B-STK

Height: 6"

HS-B-STK

Height: 6"

TS-T-Q

B = Barbed, F = Full, H = Half, Q = Quarter, STK = Stake, T = Threaded

For a more robust overhead micro spray system, pair Short-Radius Micro Spray Nozzles with Pro-Spray® Sprinkler Bodies.



Short-Radius Micro Spray Nozzles
Page 72

RIGID RISERS

These risers maintain their stiffness even when used with Micro Sprays, making them a perfect choice for high-throw applications.

KEY BENEFITS

- For rugged system designs
- Accepts 10-32 threaded components
- Perfect for annual flower beds and planters
- Inlet configurations: ½" FPT, ¼" barb, or blank
- HDPE construction

OPERATING SPECIFICATIONS

- Warranty period: 1 year

RIGID RISER MODEL CHART

Model	Description
RR12	12" Rigid Riser
RR12-T	12" Rigid Riser with ½" threaded base
RR12-B	12" Rigid Riser with ¼" barb base



Rigid Riser

Available in 12" inlet options

MULTI-PURPOSE BOX

This sturdy box is just the right size to provide protection and easy access to essential irrigation components.

KEY BENEFITS

- Small footprint in a sturdy, durable box
- Five color offerings blend in with any environment
- Overlapping lid prevents debris from entering box
- Knock-out bolt hole
- UV-protected, non-slip lid

PRODUCT SPECIFICATIONS

- Fits small control zone kits and other assorted components
- Durable HDPE construction
- 3/8" bolt included with every box
- Warranty period: 2 years



Multi-Purpose Box

Top
Width: 7½"
Length: 10½"

Bottom
Width: 8½"
Length: 11½"

Height: 8"



MB-LID-B



MB-LID-G



MB-LID



MB-LID-R



MB-LID-T

Multi-Purpose Box Installed



MULTI-PURPOSE BOX

Model	Description
MB-0811	Multi-Purpose Box with standard brown lid
MB-0811-G	Multi-Purpose Box with green lid
MB-0811-T	Multi-Purpose Box with tan lid
MB-0811-R	Multi-Purpose Box with purple lid
MB-0811-B	Multi-Purpose Box with black lid
MB-BOX	Multi-Purpose Box (box only)
MB-LID	Multi-Purpose Box (lid only, brown)
MB-LID-G	Multi-Purpose Box (lid only, green)
MB-LID-T	Multi-Purpose Box (lid only, tan)
MB-LID-R	Multi-Purpose Box (lid only, purple)
MB-LID-B	Multi-Purpose Box (lid only, black)

AIR/VACUUM RELIEF VALVE

Prevent water hammer and system collapse by discharging air during startup and allowing air to enter during shutdown.

KEY BENEFITS

- Releases air pockets without premature closure
- Leak-free closure after release
- Helps prevent system collapse through vacuum relief

PRODUCT SPECIFICATIONS

- UV-protected and corrosion-resistant material

OPERATING SPECIFICATIONS

- Pressure range: up to 80 PSI
- Warranty period: 2 years



AVR-075

Height: 5"
Width: 2"
Inlet: 3/4" MPT



PLD-AVR

Height: 1"
Width: 3/4"
Inlet: 1/2"

Air/Vacuum Relief Valve Installed



AUTOMATIC FLUSH VALVE

Keep laterals clean by automatically flushing water, air, and debris at each system startup.

KEY BENEFITS

- Flushes debris automatically at every system startup
- Reversible diaphragm to coordinate with low or high flow
- Lateral placement provides better grit tolerance

PRODUCT SPECIFICATIONS

- Removable top for diaphragm maintenance

OPERATING SPECIFICATIONS

- Pressure range: up to 60 PSI
- Low-flow diaphragm side: 2 to 5 GPM
- High-flow diaphragm side: 5 to 12 GPM
- AFV-075: Auto flush at 5 PSI
- Warranty period: 1 Year



AFV-B

Automatic Flush Valve with 17 mm barb connection



AFV-T

Automatic Flush Valve with 1/2" MPT connection



AFV-075

Automatic Flush Valve with 3/4" FNPT connection

Automatic Flush Valve Installed



RECLAIMED

RECLAIMED



RECLAIMED

EMBRACE THE POWER OF PURPLE

with our complete line of reclaimed water products

ROTORS



PGJ	PGP [®] ULTRA	I-20	I-25	I-40
PGJ-00-R	PGP-00-CV-R	I-20-00-R	I-25-04-R	I-40-04-SS-R
PGJ-04-R	PGP-00-CV-R-PRB	I-20-00-R-PRB	I-25-04-SS-R	I-40-04-SS-ON-R
PGJ-06-R	PGP-04-CV-R	I-20-04-R	I-25-06-R	I-40-06-SS-R
PGJ-12-R	PGP-04-CV-R-PRB	I-20-04-SS-R	I-25-06-SS-R	I-40-06-SS-ON-R
	PGP-06-CV-R	I-20-04-R-PRB		
	PGP-12-CV-R	I-20-04-SS-R-PRB		
		I-20-06-R		
		I-20-06-SS-R		
		I-20-06-R-PRB		
		I-20-06-SS-R-PRB		
		I-20-12-R		

Rotors Key

00 - Shrub
04 - 4" pop-up
06 - 6" pop-up

12 - 12" pop-up
CV - Check valve
SS - Stainless steel

ON - Opposing nozzles
PRB - Pressure-regulated
body

ARV - Adjustable arc
3RV - Full-circle

ROTORS



I-80	I-90
I-80-04-SS-R	I-90-ARV
I-80-04-SS-ON-R	I-90-3RV

SPRINKLER BODIES



PRO-SPRAY [®]	PRO-SPRAY PRS30	PRO-SPRAY PRS40
PROS-00-R	PROS-00-PRS30-R	PROS-00-PRS40-R
PROS-04-CV-R	PROS-04-PRS30-CV-R	PROS-04-PRS40-CV-R
PROS-06-CV-R	PROS-06-PRS30-CV-R	PROS-06-PRS40-CV-R
PROS-12-CV-R	PROS-12-PRS30-CV-R	PROS-12-PRS40-CV-R
PROS-RC-CAP-SP (snap-on)	PROS-04-PRS30-CV-F-R	PROS-04-PRS40-CV-F-R
458520SP = ID cap (threaded)	PROS-06-PRS30-CV-F-R	PROS-06-PRS40-CV-F-R
	PROS-12-PRS30-CV-F-R	PROS-12-PRS40-CV-F-R
	458560 = ID cap	458562 = ID cap

Sprays Key

00 - Shrub
04 - 4" pop-up

06 - 6" pop-up
12 - 12" pop-up

CV - Check valve
F - FloGuard[™] Technology

RECLAIMED

BUBBLERS

VALVES



BUBBLERS

- PCB-25-R
- PCB-50-R
- PCB-10-R
- PCB-20-R



ICV VALVE

- ICV-151G-FS-R
- ICV-201G-FS-R
- 561205 = ICV-101-201 series ID handle
- 515005 = ICV-301 series ID handle



IBV VALVE

- IBV-151G-FS-R
- IBV-201G-FS-R



QUICK COUPLERS

- HQ-33-DLRC-R
- HQ-44-LRC-R
- HQ-44-LRC-AW-R
- HQ-5-LRC-R



DRIP CONTROL ZONE KITS

- ICZ-101-25-LF-R
- ICZ-101-40-LF-R
- HFR-100-075-25-R
- HFR-100-075-40-R

Bubblers Key

- 25 - 0.25 GPM
- 50 - 0.50 GPM
- 10 - 1.00 GPM
- 20 - 2.00 GPM

Valves Key

- FS - Filter Sentry® Mechanism
- * Note: IBV purple tags are user-installed options.

Quick Couplers Key

- LRC - Locking rubber cover
- RC - Rubber cover
- AW - Acme key with anti-rotation wheels

MICRO



IH RISERS

- IH-RISER-XX-R
- IH-FIT-3850-R



ROOT ZONE WATERING SYSTEM

- | | |
|-----------------|------------------------------|
| RZWS-10-R | RZWS-36-R |
| RZWS-10-25-R | RZWS-36-25-R |
| RZWS-10-50-R | RZWS-36-50-R |
| RZWS-10-25-CV-R | RZWS-36-25-CV-R |
| RZWS-10-50-CV-R | RZWS-36-50-CV-R |
| RZWS-18-R | 913301SP |
| RZWS-18-25-R | (purple cap for 18" and 36") |
| RZWS-18-50-R | RZWS-10-RCC |
| RZWS-18-25-CV-R | (purple cap for 10") |
| RZWS-18-50-CV-R | |



HUNTER DRIPLINE

- HDL-06-12-250-R
- HDL-06-12-1K-R
- HDL-06-18-250-R
- HDL-06-18-1K-R
- HDL-09-12-250-R
- HDL-09-12-1K-R
- HDL-09-18-250-R
- HDL-09-18-1K-R
- HDL-BLNK-500-R



ECO-INDICATOR

- ECO-ID-12-R



MULTI-PURPOSE BOX

- MB-0811-R
- MB-LID-R (lid only)

Micro Key

IH Risers

- XX = Riser Length
- 06 = 6"
- 12 = 12"
- 18 = 18"
- 24 = 24"
- 36 = 36"

RZWS

- | | |
|-----------------|------------------|
| 10 - 10" length | 25 - 0.25 GPM |
| 18 - 18" length | 50 - 0.50 GPM |
| 36 - 36" length | CV - Check valve |

HDL

- | | | |
|-------------------|------------------|--------------------|
| BLNK - No emitter | 12 - 12" spacing | 250 - 250' length |
| HDL-04 - 0.4 GPH | 18 - 18" spacing | 500 - 500' length |
| HDL-06 - 0.6 GPH | 24 - 24" spacing | 1K - 1,000' length |
| HDL-09 - 0.9 GPH | | |

RECLAIMED



TOOLS

SPOTSHOT HOSE-END NOZZLE

MODELS

- ¾" hose thread inlet - P/N 160700
- 1" hose thread inlet - P/N 160705

KEY BENEFITS

- Variable nozzle stream choices:
 - Fan: Broad, light stream for turf hot spots
 - Soak: Medium stream for dust-control areas
 - Jet: Tight, focused stream for power washing

OPERATING SPECIFICATIONS

- Flow - 35 GPM at 80 PSI*

* Not recommended for residential use with regulated, low-pressure, or low-flow conditions



SpotShot Hose-End Nozzle

¾" P/N 160700SP

1" P/N 160705SP



Pitot Gauge

P/N 280100SP

Used to check operating pressure of rotor sprinklers



MP Gauge Assembly

P/N MPGAUGE

Used to check operating pressure on spray body sprinklers



Hand Pump

P/N 217500SP

Used to remove water from flooded areas during service and installation



Nozzle Insertion Collar

P/N 123200SP



Hunter Wrench

P/N 172000SP



T-Handle Tool

P/N 319100SP



Nozzle Removal/ Installation Tool

P/N 803700SP

5/16" Nut Driver used with I-80 Rotor short and mid-range nozzles



Snap Ring Removal Tool

P/N 251000SP

Use with I-80 Rotor

RESOURCES



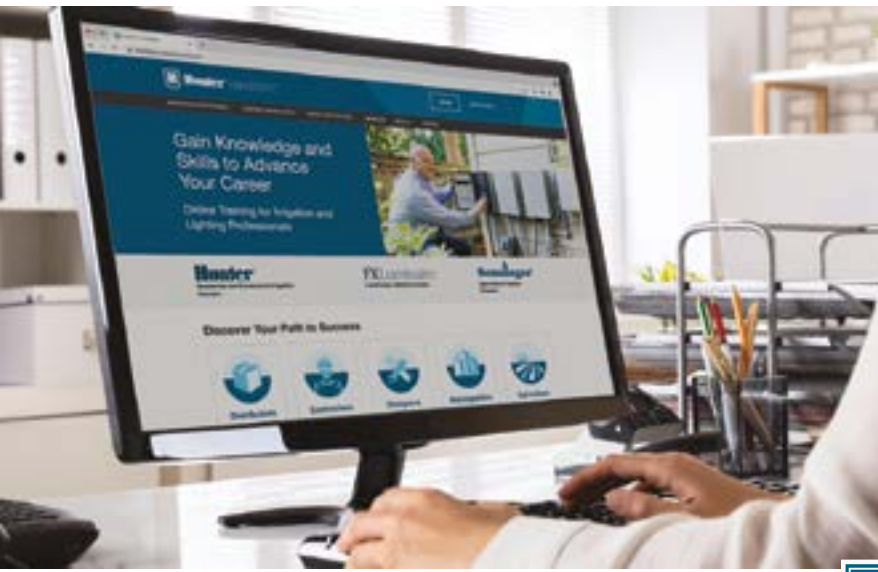

HUNTER UNIVERSITY

hunter.info/hunteruniversity

Advance your career with our comprehensive online training certificate programs for irrigation professionals. From fundamental product knowledge to advanced control systems and design techniques, there's a professional development program waiting for you!

Learn more at training.hunterindustries.com.

Find Your Path to Success

1. Access free online product training at training.hunterindustries.com.
2. Choose the programs or courses that best fit your needs.

Earn certificates and badges to show off your expertise and receive continuing education credits from the Irrigation Association to meet professional requirements.

On-Site Expert Workshops

These interactive, instructor-led courses feature a hands-on approach to learning. Classes are held at the Hunter campus in San Marcos, California, and select locations worldwide. To learn more, contact training@hunterindustries.com.

Learn Hands-On Fundamentals!

Irrigation Installation Fundamentals

For reliable long-term performance, all irrigation system components must be installed correctly. Learn installation best practices today.

Irrigation Certificate Programs

- Product Specialist (Core and Advanced)
- Irrigation Designer
- Hydrowise® Specialist
- X2™ Specialist
- Irrigation Installation Fundamentals
- Valve Technician ◆ NEW
- S.T.A.R. Distributor
- EZ Decoder System Specialist ◆ NEW
- EZ Decoder System Technician ◆ NEW

EDUCATION, TOOLS, AND SUPPORT FOR PROFESSIONALS

Exclusive Resources to Help You Grow

As your partner in business development, we know you need more than top-quality products to increase profits, provide excellent customer service, and stand out against the competition. We're proud to provide a full suite of free tools, services, and programs to help irrigation professionals of all backgrounds succeed. Learn more at [hunter.direct/tools](https://hunterdirect.com/tools).



THE VAULT

vault.hunterindustries.com

Unlock your potential with The Vault by learning new facts, earning coins, and working your way towards awesome prizes.



WATER SAVINGS CALCULATOR

hunter.info/savingscal

Show your customers how much water — and money — they can save by upgrading to a more efficient irrigation system.



SITEREC APP

hunter.info/siterec

Close sales faster! Confidently present proposals to your customers. Add your logo and business details for a professional presentation.



RUN TIME CALCULATOR

hunter.info/runtime

Use this helpful calculator to generate the most efficient irrigation schedule for every landscape and prevent wasteful runoff.



MY LIST

hunter.info/mylist

Build customized product lists for every project. Email lists to distributors for faster ordering and add pricing and notes to each project.



DRIPLINE CALCULATOR

hunter.info/dripcal

Eliminate guesswork with this handy tool. See site recommendations, determine product quantities, and calculate run times in a simple format.



CAD LEGENDS

hunter.info/cadlegends

To help you complete projects accurately in CAD software, we offer a range of irrigation legends that show proper specification.



VIRTUAL ENGAGEMENT CENTER

vec.hunterindustries.com

Learn about our latest irrigation products in a fun, informative, and immersive digital space.



CAD DETAILS

hunter.info/caddetails

To streamline the irrigation design process, we provide installation CAD details in PDF, DWG, and DXF formats.



SITE STUDY LIBRARY

hunter.info/sitestudies

See how Hunter irrigation products have transformed parks, sports fields, and outdoor living spaces around the world.



BIM 3D MODELS

hunter.info/bimmodels

BIM uses advanced 3D modeling to develop irrigation specification documents. Find BIM-supported products for your next project.



VIDEO LIBRARY

hunter.info/videolibrary

Visit our comprehensive video library to discover key product benefits, hear from experts, find installation tips, and more.

FOLLOW US TO STAY ON TOP OF OUR LATEST PRODUCT NEWS, PROMOTIONS, INSTALLATION TIPS, AND MORE!



PRECIPITATION RATES



In this section, the “Sprinkler Spacing Method – Any Arc and Any Spacing” equation is used to calculate precipitation rates. The first set of equations with the ■ shows the precipitation rate for the sprinklers when they are laid out in a square pattern. The next set with the ▲ shows the precipitation rate for the sprinklers laid out in an equilateral triangular spacing pattern. This is the “Sprinkler Spacing Method – Equilateral Triangular Spacing” equation.

WHAT IS “PRECIPITATION RATE”?

If someone said they were caught in a rainstorm that dropped one inch of water in an hour, you would have some idea of how “hard” or “heavily” the rain came down. A rainstorm that covers an area with one inch of water in one hour has a “precipitation rate” of one inch per hour (1 in/hr or 25 mm/hr). Similarly, the precipitation rate is the “speed” at which a sprinkler or an irrigation system applies water.

MATCHED PRECIPITATION RATES

A zone or system in which all the heads have similar precipitation rates is said to have “matched precipitation rates.” Systems that have matched precipitation rates reduce wet and dry spots and minimize run times, which reduces water consumption and lowers costs. Knowing that sprinkler spacing, flow rates, and arcs of coverage affect precipitation rates, a general guideline is: as the spray arc doubles, so should the flow.

 90° Arc = 1 GPM (0.23 m ³ /hr; 3.8 l/min)	 180° Arc = 2 GPM (0.45 m ³ /hr; 7.6 l/min)	 360° Arc = 4 GPM (0.91 m ³ /hr; 15.1 l/min)
------------------------------------------------------------------------------------------------------------------------------------------	--------------------------------------------------------------------------------------------------------------------------------------------	-----------------------------------------------------------------------------------------------------------------------------------------------

The flow rate of half-circle heads must be two times the flow rate of the quarter-circle heads, and the full-circle heads must have two times the flow rate of the half-circle heads. In the illustration, the same amount of water is applied to each quarter circle area, and precipitation is therefore matched.

CALCULATING PRECIPITATION RATES

Depending upon the construction of the irrigation system, the precipitation rate may be calculated by either a Sprinkler Spacing or a Total Area method.

Sprinkler Spacing Method (■)

The precipitation rate should be calculated for each individual zone. If all sprinkler heads on the zone have the same spacing, flow rate, and arc of coverage, use one of the following formulas:

Any Arc and Any Spacing (■):

$$\begin{aligned} \text{P.R. (in/hr)} &= \frac{\text{Flow Rate (GPM) for any Arc} \times 34,650}{\text{Degrees of Arc} \times \text{Head Spacing (ft.)} \times \text{Row Spacing (ft.)}} \\ \text{P.R. (mm/hr)} &= \frac{\text{Flow Rate (m}^3\text{/hr) for any Arc} \times 360,000}{\text{Degrees of Arc} \times \text{Head Spacing (m)} \times \text{Row Spacing (m)}} \\ \text{P.R. (mm/hr)} &= \frac{\text{Flow Rate (l/min) for any Arc} \times 21,600}{\text{Degrees of Arc} \times \text{Head Spacing (m)} \times \text{Row Spacing (m)}} \end{aligned}$$

Sprinkler Spacing Method (▲)

The precipitation rate should be calculated for each individual zone. If all sprinkler heads on the zone have the same spacing, flow rate, and arc of coverage, use one of the following formulas:

Equilateral Triangular Spacing (▲):

$$\begin{aligned} \text{P.R. (in/hr)} &= \frac{\text{Flow Rate (GPM) for any Arc} \times 34,650}{\text{Degrees of Arc} \times (\text{Head Spacing})^2 \times 0.866} \\ \text{P.R. (mm/hr)} &= \frac{\text{Flow Rate (m}^3\text{/hr) for any Arc} \times 360,000}{\text{Degrees of Arc} \times (\text{Head Spacing})^2 \times 0.866} \\ \text{P.R. (mm/hr)} &= \frac{\text{Flow Rate (l/min) for any Arc} \times 21,600}{\text{Degrees of Arc} \times (\text{Head Spacing})^2 \times 0.866} \end{aligned}$$

Total Area Method

The precipitation rate for a “system” is the average precipitation rate of all sprinklers in an area, regardless of the spacing, flow rate, or arc for each head. The Total Area Method calculates all the flows of all of the heads in any given area.

$$\begin{aligned} \text{P.R. (in/hr)} &= \frac{\text{Flow (GPM)} \times 96.25}{\text{Total Area (ft.)}} \\ \text{P.R. (mm/hr)} &= \frac{\text{Flow (m}^3\text{/hr)} \times 1,000}{\text{Total Area (m}^2\text{)}} \\ \text{P.R. (mm/hr)} &= \frac{\text{Flow (l/min)} \times 60}{\text{Total Area (m}^2\text{)}} \end{aligned}$$

SLOPE EQUIVALENTS/IRRIGATION

PERCENT, ANGLE, RATIO

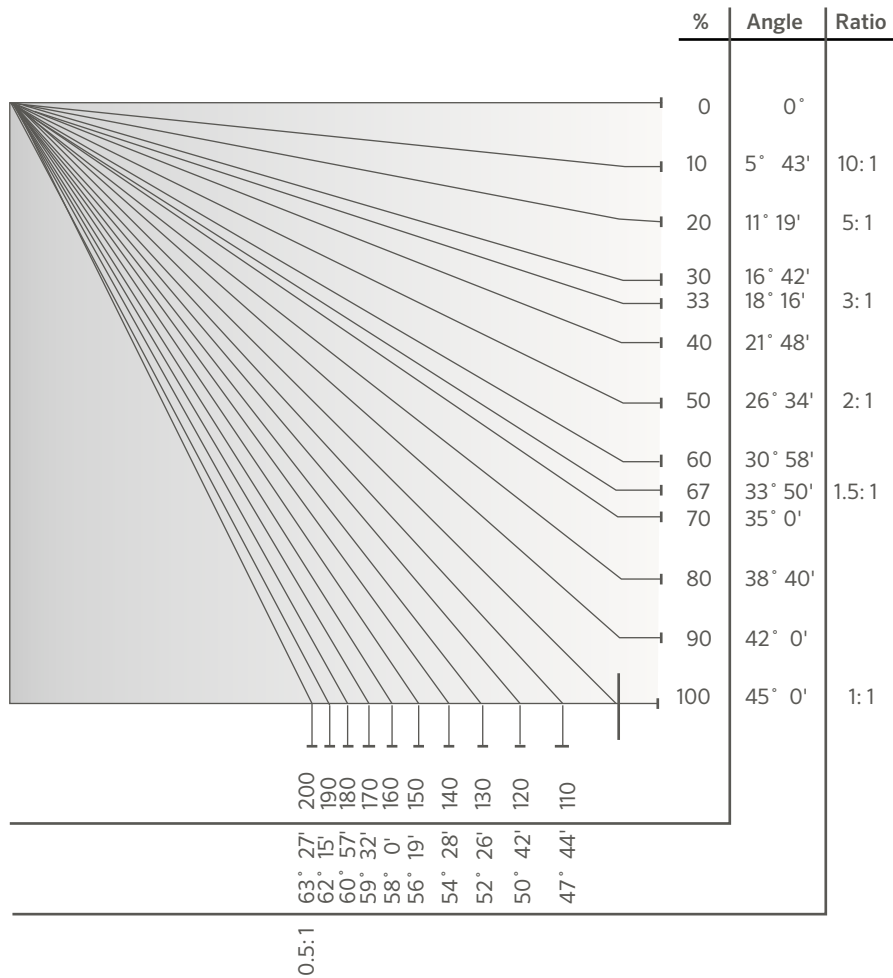

SLOPE IRRIGATION: Maximum precipitation rates for slopes in in/hr

Soil Texture	0 to 5% Slope		5 to 8% Slope		8 to 12% Slope		12%+ Slope	
	Cover	Bare	Cover	Bare	Cover	Bare	Cover	Bare
Coarse sandy soils	2.0	2.0	2.0	1.5	1.5	1.0	1.0	0.5
Coarse sandy soils over compact subsoils	1.75	1.5	1.25	1.0	1.0	0.75	0.75	0.4
Light sandy loams uniform	1.75	1.0	1.25	0.8	1.0	0.6	0.75	0.4
Light sandy loams over compact subsoils	1.25	0.75	1.0	0.5	0.75	0.4	0.5	0.3
Uniform silt loams	1.0	0.5	0.8	0.4	0.6	0.3	0.4	0.2
Silt loams over compact subsoil	0.6	0.3	0.5	0.25	0.4	0.15	0.3	0.1
Heavy clay or clay loam	0.2	0.15	0.15	0.10	0.12	0.08	0.1	0.06

Notes:

The maximum precipitation values listed below are those suggested by the United States Department of Agriculture. The values are average and may vary with respect to actual soil and groundcover conditions.

HEIGHT OF SPRAY

When designing and installing irrigation systems, it's important to know the trajectory and spray height of the water stream leaving the sprinkler nozzle.

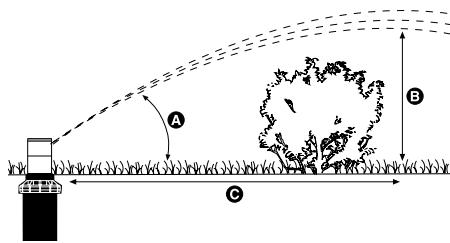

These rotor nozzle trajectory charts are designed to help determine how close a sprinkler can be placed to an object such as a fence or hedge without obstructing the spray pattern. All information shown is at optimum operating pressures.

HUNTER NOZZLE HEIGHT AND TRAJECTORY CHART						
Model	Nozzle No.	Pressure (PSI)	Degrees of Trajectory	Max Height of Spray	Distance from Head to Maximum Height (ft)	
MP ROTATOR®	800SR	40	18	18"	Varies	
	815	40	15	12"	Varies	
	1000	40	20	20"	Varies	
	2000	40	26	45"	Varies	
	3000	40	26	79"	Varies	
	3500	40	26	79"	Varies	
	Corner	40	14	14"	Varies	
	Side Strip	40	16	19"	Varies	
	Left Strip	40	16	18"	Varies	
PGJ / SRM	0.50	40	10	2'	4	
	0.75	40	10	2'	4	
	1.0	40	10	2'	8	
	1.5	40	10	3'	12	
	2.0	40	15	5'	16	
	2.5	40	15	5'	20	
	3.0	40	15	5'	20	
	4.0	40	15	5'	22	
PGP® RED NOZZLES	1	50	26	7'	22	
	2	50	26	7'	22	
	3	50	26	8'	23	
	4	50	26	8'	23	
	5	50	27	9'	26	
	6	50	27	10'	28	
	7	50	26	11'	30	
	8	50	26	11'	30	
	9	50	27	12'	32	
	10	60	25	13'	32	
	11	60	25	13'	38	
	12	60	25	13'	40	
PGP LOW-ANGLE GRAY NOZZLES	4	50	15	5'	22	
	5	50	15	4'	22	
	6	50	14	4'	22	
	7	50	14	4'	22	
	8	50	14	5'	24	
	9	50	15	5'	26	
	10	60	15	6'	30	
	PGP BLUE NOZZLES	1.5	45	25	8'	23
		2.0	45	25	8'	23
		2.5	45	25	9'	26
3.0		45	25	10'	28	
4.0		45	25	11'	30	
5.0		45	25	11'	30	
6.0		55	25	12'	32	
8.0		55	25	13'	32	
PGP ULTRA/I-20 DARK BLUE NOZZLES	1.0	50	26	8'	23	
	1.5	50	26	8'	23	
	2.0	50	27	9'	26	
	3.0	50	27	10'	28	
	3.5	50	26	11'	30	
	4.0	50	26	11'	30	
	6.0	50	27	12'	32	
	8.0	60	25	13'	32	
PGP ULTRA/I-20 BLUE NOZZLES	1.5	45	25	8'	23	
	2.0	45	25	8'	23	
	2.5	45	25	9'	26	
	3.0	45	25	10'	28	
	4.0	45	25	11'	30	
	5.0	45	25	11'	30	
	6.0	55	25	12'	32	
	8.0	55	25	13'	32	

HEIGHT OF SPRAY

HUNTER NOZZLE HEIGHT AND TRAJECTORY CHART

Model	Nozzle No.	Pressure (PSI)	Degrees of Trajectory	Max Height of Spray	Distance from Head to Maximum Height (ft)
PGP® Ultra/I-20 Low-Angle Gray Nozzles	2.0LA	50	13	5	22
	2.5LA	50	13	4	22
	3.5LA	50	13	4	22
	4.5LA	50	13	4	22
PGP Ultra/I-20 Short-Radius Black Nozzles	0.5	50	15	5	8
	1.0	50	14	6	9
	2.0	50	3	1	6
PGP Ultra/I-20 Short-Radius Black Nozzles	0.75	50	22	7	13
	1.5	50	18	7	13
	3.0	50	8	1	6
PGP Ultra/I-20 MPR-25 Red Nozzles	Q - 90	45	22	3	15
	T - 120	45	21	4	14
	H - 180	45	24	4	14
	F - 360	45	22	4	10
PGP Ultra/I-20 MPR-30 Lt. Green Nozzles	Q - 90	45	28	5	18
	T - 120	45	14	3	17
	H - 180	45	16	4	16
	F - 360	45	18	2	13
PGP Ultra/I-20 MPR-35 Tan Nozzles	Q - 90	45	28	6	19
	T - 120	45	28	6	18
	H - 180	45	16	4	17
	F - 360	45	14	3	12
I-25	4	50	25	9	22
	7	50	25	10	28
	8	50	25	11	28
	10	60	25	12	30
	13	60	25	13	31
	15	60	25	12	31
	18	60	25	15	34
	20	70	25	15	35
	23	70	25	16	38
	25	70	25	16	38
28	70	25	17	40	
I-40 Adjustable	8	50	25	12	32
	10	60	25	14	32
	13	60	25	14	34
	15	60	25	15	42
	23	70	25	17	46
I-40-ON	25	70	25	17	48
	15	50	25	15	42
	18	60	25	16	43
	20	60	25	17	45
	23	60	25	17	46
25	70	25	17	48	
28	70	25	17	50	

HUNTER NOZZLE HEIGHT AND TRAJECTORY CHART

Model	Nozzle No.	Pressure (PSI)	Degrees of Trajectory	Max Height of Spray	Distance from Head to Maximum Height (ft)
I-80 & I-90 ADV	23	80	22.5	14	37
	25	80	22.5	15	40
	33	80	22.5	15	42
	38	80	22.5	16	48
	43	80	22.5	16	48
	48	80	22.5	17	54
	53	80	22.5	17	56
	63	80	22.5	18	64
	73	80	22.5	19	68
I-80-ON & I-90 36V	23	80	22.5	7	34
	25	80	22.5	8	36
	33	80	22.5	8	38
	38	80	22.5	9	40
	43	80	22.5	9	41
	48	80	22.5	10	43
	53	80	22.5	11	45
	63	80	22.5	12	48
73	80	22.5	13	52	

MLD FLOW CHART

MLD FLOW CHART

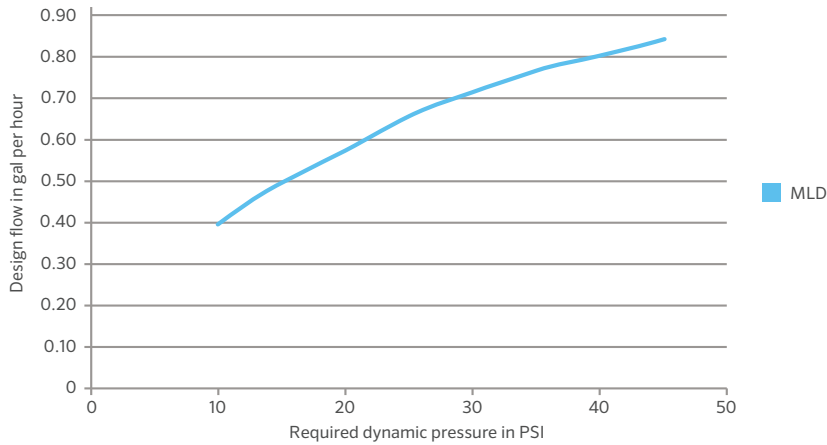

HDL MAXIMUM RUN LENGTHS

HDL-CV - 0.4 GPH

Pressure (PSI)	Emitter Spacing (in.)		
	12	18	24
15	205	289	367
20	289	404	513
25	339	479	604
30	380	535	679
40	438	623	788
50	489	691	872
60	529	747	947

HDL-CV - 0.6 GPH

Pressure (PSI)	Emitter Spacing (in.)		
	12	18	24
15	171	239	304
20	239	336	426
25	280	398	501
30	314	441	560
40	363	516	653
50	404	570	722
60	438	619	784

HDL-CV - 0.9 GPH

Pressure (PSI)	Emitter Spacing (in.)		
	12	18	24
15	117	164	211
20	164	233	292
25	192	273	348
30	217	307	389
40	251	355	451
50	280	395	501
60	302	429	541

HDL-PC/R - 0.4 GPH

Pressure (PSI)	Emitter Spacing (in.)		
	12	18	24
10	205	285	361
15	285	404	511
20	339	475	604
25	380	532	675
30	411	582	735
40	463	657	831
50	507	719	912
60	548	772	981

HDL-PC/R - 0.6 GPH

Pressure (PSI)	Emitter Spacing (in.)		
	12	18	24
10	168	236	298
15	236	333	423
20	280	395	501
25	314	441	560
30	339	482	610
40	385	545	688
50	419	594	753
60	451	638	810

HDL-PC/R - 0.9 GPH

Pressure (PSI)	Emitter Spacing (in.)		
	12	18	24
10	114	164	208
15	164	233	292
20	192	273	348
25	214	304	385
30	236	333	419
40	267	376	479
50	292	414	523
60	314	441	560

HDL-COP - 0.6 GPH

Pressure (PSI)	Emitter Spacing (in.)	
	12	18
15	171	239
20	239	336
25	280	398
30	314	441
40	363	516
50	404	570
60	438	619

HDL-COP - 0.9 GPH

Pressure (PSI)	Emitter Spacing (in.)	
	12	18
15	117	164
20	164	233
25	192	273
30	217	307
40	251	355
50	280	395
60	302	429

CONVERSION FACTORS

CONVERSION FACTORS			
To Convert	From	To	Multiply By
Area	acres	foot ²	43560
	acres	meter ²	4046.8
	meter ²	foot ²	10.764
	foot ²	inch ²	144
	inch ²	centimeter ²	6.452
	hectares	meter ²	10000
	hectares	acres	2.471
Power	kilowatts	horsepower	1.341
Flow	foot ³ /minute	meter ³ /second	0.0004719
	foot ³ /second	meter ³ /second	0.02832
	yards ³ /minute	meter ³ /second	0.01274
	gallon/minute	meter ³ /hour	0.22716
	gallon/minute	liter/minute	3.7854
	gallon/minute	liter/second	0.06309
	meter ³ /hour	liter/minute	16.645
	meter ³ /hour	liter/second	0.2774
	liter/minute	liter/second	60
Length	foot	inch	12
	inch	centimeter	2.54
	foot	meter	0.30481
	kilometer	miles	0.6214
	miles	foot	5280
	miles	meter	1609.34
	millimeter	inch	0.03937
Pressure	PSI	kilopascals	6.89476
	PSI	bar	0.068948
	bar	kilopascals	100
	PSI	feet of head	2.31
Velocity	feet/second	meter/second	0.3048
Volume	feet ³	gallon	7.481
	feet ³	liter	28.32
	meter ³	feet ³	35.31
	meter ³	yard ³	1.3087
	yard ³	feet ³	27
	yard ³	gallon	202
	acres/feet	foot ³	43,560
	gallon	meter ³	0.003785
	gallon	liter	3.785
	imperial gallon	gallon	1.833

FRICION LOSS CHARTS

WATER METER PRESSURE LOSS CHART: Typical Pressure Loss (PSI)

Flow (GPM)	5/8"	3/4"	1"	1½"	2"	3"	4"	Flow (GPM)
1	0.2	0.1						1
2	0.3	0.2						2
3	0.4	0.3						3
4	0.6	0.5	0.1					4
5	0.9	0.6	0.2					5
6	1.3	0.7	0.3					6
7	1.8	0.8	0.4					7
8	2.3	1.0	0.5					8
9	3.0	1.3	0.6					9
10	3.7	1.6	0.7					10
11	4.4	1.9	0.8					11
12	5.1	2.2	0.9					12
13	6.1	2.6	1.0					13
14	7.2	3.1	1.1					14
15	8.3	3.6	1.2					15
16	9.4	4.1	1.4	0.4				16
17	10.7	4.6	1.6	0.5				17
18	12.0	5.2	1.8	0.6				18
19	13.4	5.8	2.0	0.7				19
20	15.0	6.5	2.2	0.8				20
22		7.9	2.8	1.0				22
24		9.5	3.4	1.2				24
26		11.2	4.0	1.4				26
28		13.0	4.6	1.6				28
30		15.0	5.3	1.8	0.7			30
32			6.0	2.1	0.8			32
34			6.9	2.4	0.9			34
36			7.8	2.7	1.0			36
38			8.7	3.0	1.2			38
40			9.6	3.3	1.3			40
42			10.6	3.6	1.4			42
44			11.7	3.9	1.5			44
46			12.8	4.2	1.6			46
48			13.9	4.5	1.7			48
50			15.0	4.9	1.9			50
52				5.3	2.1			52
54				5.7	2.2			54
56				6.2	2.3			56
58				6.7	2.5			58
60				7.2	2.7	1.0		60
65				8.3	3.2	1.1		65
70				9.8	3.7	1.3		70
75				11.3	4.3	1.5		75
80				12.8	4.9	1.6	0.7	80
90				16.1	6.2	2.0	0.8	90
100				20.0	7.8	2.5	0.9	100
110					9.5	2.9	1.0	110
120					11.3	3.4	1.2	120
130					13.0	3.9	1.4	130
140					15.1	4.5	1.6	140
150					17.3	5.1	1.8	150
160					20.0	5.8	2.1	160
170						6.5	2.4	170
180						7.2	2.7	180
190						8.0	3.0	190
200						9.0	3.2	200
220						11.0	3.9	220
240						13.0	4.7	240
260						15.0	5.5	260
280						17.3	6.3	280
300						20.0	7.2	300
350							10.0	350
400							13.0	400
450							16.2	450
500							20.0	500

75% of max meter capacity 15 GPM 22.5 GPM 37.5 GPM 75 GPM 120 GPM 225 GPM 375 GPM 75% of max meter capacity

Notes: Shaded areas represent velocities over 5 fps. Use with caution when water hammer is a concern.

FRICTION LOSS CHARTS

TABLE OF APPROXIMATE PRESSURE LOSSES FOR PIPE FITTINGS (LISTED IN EQUIVALENT FEET OF PIPE)

Steel Fitting Type	½"	¾"	1"	1¼"	1½"	2"	2½"	3"	4"	6"	8"
Coupling	0.6	0.8	1	1.2	1.5	2	2.5	3	4	6	8
Run of St. Tee	1	1	1.5	2	2	2.5	3	4	5	7	10
Tee, Side Outlet	3	4.5	5	7	9	11	13	16	20	31	42
Tee, Run Reduced ½"	1.5	2.5	3	4	5	6	7	8	12	16	20
Elbow, 90°	1.5	2.5	3	4	5	6	7	8	12	16	20
Elbow, 45°	0.75	1	1.3	1.7	2	2.5	3	3.5	5	7.5	10
Corporation Stop	9	9	9	9	9	9					
Curb Stop	6	6	7	7	8	8					

Plastic IPS or Copper Fitting Type	½"	¾"	1"	1¼"	1½"	2"	2½"	3"	4"	6"	8"
Coupling	1.5	2.5	3.0	3.0	4.0	6.0	7.0	8.0	11.0	18.0	24.0
Run of St. Tee	2.5	3.0	4.0	5.0	6.0	8.0	9.0	11.0	15.0	21.0	28.0
Tee, Side Outlet	7.0	9.0	12.0	15.0	18.0	24.0	30.0	36.0	45.0	70.0	90.0
Tee, Run Reduced ½"	3.5	4.5	6.0	8.0	9.0	11.0	14.0	17.0	24.0	34.0	45.0
Elbow, 90°	3.5	4.5	6.0	8.0	9.0	11.0	14.0	17.0	24.0	34.0	45.0
Elbow, 34°	1.5	2.0	3.0	3.5	4.0	5.0	7.0	8.0	10.0	16.0	20.0

To use this chart, multiply the approximate "equivalent feet of pipe" value by the proper pipe pressure loss per 100 ft. rating, then divide by 100. The result is the fitting loss in PSI.

Note: It is recommended that the charts above only be used when the manufacturer's recommended pressure loss values are not available.

ACCESSORY PRESSURE LOSS CHARTS

HCV PRESSURE LOSS CHART

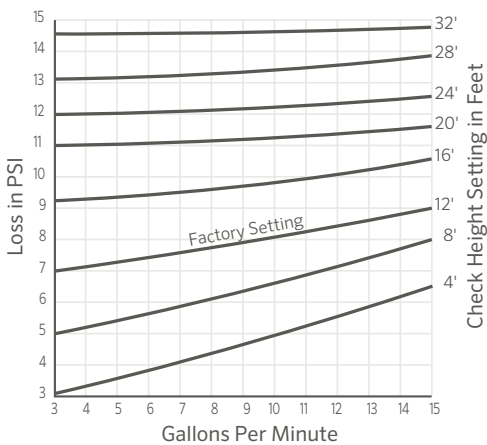

For more information, see the Hunter Check Valve section on **page 30**

SJ SWING JOINT FRICTION LOSS

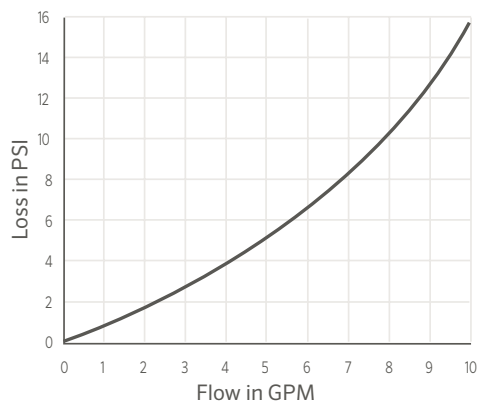

For more information, see the Spray Accessories section on **page 62**

PRESSURE LOSS CHARTS

BTT 1-ZONE Inlet Size 3/4", Flow Rate: 1 to 8 GPM	
GPM	Pressure Loss
1	4
2	5
3	6
4	8
5	11
6	15
7	20
8	26

Note: Maximum flow at 50 PSI

BTT 2-ZONE Inlet Size 3/4", Flow Rate: 1 to 8 GPM	
GPM	Pressure Loss
1	2
2	3
3	5
4	7
5	10
6	14
7	18
8	24

Note: Maximum flow at 50 PSI (1-zone activated)

For applications requiring higher efficiency and lower pressure loss, use Hunter valves and dripline products.

HY FILTER PRESSURE LOSS IN PSI (AT OPTIMAL FLOWS)						
Flow (GPM)	*HY-075 3/4"	*HY-100 1"	*HY-151 1 1/2"	**HY-151-D 1 1/2"	**HY-201 2"	**HY-201-D 2"
0.5	0	0				
2	0	0				
5	1	1				
7	2	2				
10	3	3				
15	6	6				
20	11	11	0	0	0	0
30			1	1	0	0
40			1	2	0	1
50			2	3	1	1
60			3	4	1	2
70			3	4	1	2
80			4	5	2	3
90					2	3
100					3	4

Notes: *With standard 150 mesh screen **With standard 120 mesh disc

WIRE DATA

STANDARD ANNEALED COPPER AT 68°F (20°C)						
American Wire Gauge	Common Metric Equivalent (mm ²)	Diameter (mils)	Diameter (mm)	Cross-Sectional Area (mm ²)	Resistance (Per mft ohms)	Resistance (Per km ohms)
1	50	289.3	7.348	42.4	0.924	0.407
2	35	257.6	6.543	33.6	0.156	0.513
3		229.4	5.827	26.7	0.197	0.647
4	25	204.3	5.189	21.1	0.249	0.815
5		181.9	4.62	16.8	0.313	1.028
6	16	162	4.115	13.3	0.395	1.297
7		144.3	3.665	10.6	0.498	1.634
8	10	128.5	3.264	8.36	0.628	2.061
9		114.4	2.906	6.63	0.793	2.6
10	6	101.9	2.588	5.26	0.999	3.277
11		90.7	2.3	4.17	1.26	4.14
12	4	80.8	2.05	3.31	1.59	5.21
13		72	1.83	2.63	2	6.56
14	2.5	64.1	1.63	1.63	2.52	8.28
15		57.1	1.45	1.65	3.18	10.4
16	1.5	50.8	1.29	1.31	4.02	13.2
17		45.3	1.15	1.04	5.05	16.6
18	0.75	40.3	1.02	0.82	6.39	21
19		35.9	0.912	0.65	8.05	26.4
20	0.5	32	0.813	0.52	10.1	33.2

PSR WIRE DATA

MAXIMUM WIRE LENGTH						
Model	18 AWG	16 AWG	14 AWG	12 AWG	10 AWG	8 AWG
PSR-22	243 ft	386 ft	616 ft	976 ft	1551 ft	2463 ft
PSR-52	134 ft	214 ft	341 ft	540 ft	859 ft	1365 ft
PSR-53	134 ft	214 ft	341 ft	540 ft	859 ft	1365 ft

For more information, see the Pump Start Relay section on [page 128](#).

WIRE SIZING

REQUIRED INFORMATION

- 1) Actual one-way length of wire between the controllers and the power source or the controllers and valves
- 2) Allowable voltage loss along the wire circuit
- 3) Accumulative current flowing through the wire section being sized in amperes

RESISTANCE IS CALCULATED USING THIS FORMULA:

$$R = \frac{1000 \times AVL}{2L \times I}$$

R = Maximum allowable resistance of wire in ohms per 1,000'

AVL = Allowable voltage loss

L = Wire length (one way)

I = Inrush current

AVL for controller power wire sizing is calculated by subtracting the minimum operating voltage required by the controller from the minimum available voltage at the power source.

AVL for valve wire sizing is calculated by subtracting minimum solenoid operating voltage from controller output voltage. This number will vary depending on the manufacturer and in some cases with line pressure.

VALVE WIRE SIZING EXAMPLE

Given: The distance from the controller to the valve is 1,800'. The controller output is 24 VAC. The valve has a minimum operating voltage of 20 VAC and an inrush current of 370 mA (0.37 A).

$$R = \frac{1,000 \times 4}{2(1,800) \times 0.37}$$

$$R = \frac{4,000}{1,332}$$

$$R = 3.00 \text{ ohms}/1,000 \text{ ft.}$$

So, wire resistance cannot exceed 3.00 ohms per 1,000'. Now go to table #1 and select the proper wire size. Since 18 gauge wire has more resistance than 3.00 ohms per 1,000', choose 14 gauge wire.

Table 2 is a quick reference and is set up to provide maximum wire runs given the information at the bottom of the table.

TABLE 1 - RESISTANCE OF COPPER WIRE

Wire Size (AWG)	Resistance at 20° C (68° F) (ohms per 1,000')
18	6.39
16	4.02
14	2.52
12	1.59
10	1
8	0.63
6	0.4
4	0.25

TABLE 2 - VALVE WIRE SIZING

Ground Wire	Control Wire						
	18	16	14	12	10	8	6
18	850	1040	1210	1350	1460	1540	1590
16	1040	1340	1650	1920	2150	2330	2440
14	1210	1650	2150	2630	3080	3450	3700
12	1350	1920	2630	3390	4170	4880	5400
10	1460	2150	3080	4170	5400	6670	7690
8	1540	2330	3450	4880	6670	8700	10530
6	1590	2440	3700	5400	7690	10530	13330

Notes:

Maximum one-way distance in feet between controller and valve heavy-duty solenoid: 24 VAC, 350 mA inrush current, 190 mA holding current, 60 Hz; 370 mA inrush current, 210 mA holding current, 50 Hz.

Table 2 is for a single active solenoid. With two solenoids operating simultaneously on the same wires, the wire distances should be halved.

SOLAR SYNC® CALIBRATION TABLE

Use this table to identify your region and select the closest region number based on average July ET or peak summer ET. For more information, visit hunter.info/ReferenceMap and hunter.info/SeasonalAdjustment.

CALIBRATION AND SETUP PERIOD			
Based on the ET of your region using the average July ET or peak summer ET. This is the preferred option when selecting your region.	Based on the temperature for your region using the average July or the driest month high temperature (not the highest temperature for July).	Based on the general description of your region.	Region
July* ET is 0.17" or less per day	Temperature for July* is 65° to 75°F	U.S. Northern States, Coastal Regions	1
July* ET is 0.18" to 0.23" per day	Temperature for July* is 75° to 85°F	Mountains, U.S. North Inland States	2
July* ET is 0.24" to 0.29" per day	Temperature for July* is 85° to 95°F	U.S. Southern States, Inland and High Deserts	3
July* ET is 0.30" or more per day	Temperature for July* is 95° to 105°F	Deserts	4

Notes: *For Southern Hemisphere locations, use the month of January.

ADDITIONAL DATA

MAXIMUM NUMBER OF WIRES TO BE INSTALLED IN CONDUIT OR SLEEVING													
Wire Size (AWG)	½"	¾"	1"	1¼"	1½"	2"	2½"	3"	3½"	4"	5"	6"	Wire Size (AWG)
18	6	12	20	35	49	80	110	175					18
16	5	10	16	30	42	67	97	150					16
14	4	6	10	18	25	40	56	88	120	150			14
12	3	5	7	15	20	33	50	75	102	130	205		12
10	1	3	6	13	16	27	40	63	85	110	170		10
8	1	2	4	6	9	16	25	35	50	65	105	150	8
6	1	1	3	3	5	10	15	22	32	40	63	92	6
4		1	1	2	4	7	10	16	24	30	48	70	4
2		1	1	2	2	5	9	12	18	22	36	54	2
0			1	1	2	3	5	8	12	15	24	36	0
00			1	1	1	2	4	7	10	14	21	31	00
000				1	1	2	3	6	8	11	18	26	000
0000				1	1	1	2	5	7	10	15	22	0000

STATEMENT OF WARRANTY

Hunter Residential and Commercial Irrigation Products

Hunter Industries Incorporated (“Hunter”) warrants the following products to be free of defects in materials or workmanship under normal use in landscape irrigation applications for the specified period of time outlined below from the original date of manufacture:

ONE YEAR	ROTORS	SRM	MICRO	Micro Sprays, PLD Fittings, Rigid Risers, Air/Vacuum Relief Valves
	ROTORS	PGP-ADJ, PGJ, HCV	CONTROLLERS	ACC (Legacy), BTT, FS-1000, FS-3000, I-Core/DUAL (Legacy), NODE, NODE-BT, Pro-C, PSR, ROAM, XC Hybrid, X-Core, WV, and Hydrowise Controllers (HC, X2, WAND, PHC, HPC, HCC)
TWO YEARS	SPRAYS	PS Ultra, SJ, FlexSG, HSBE	SENSORS	HC Flow Meter (wired and wireless)
	NOZZLES	Spray Nozzles, PCN, PCB, AFB, MSBN	MICRO	ACZ, Accu Sync, PCZ, RZWS, Point-Source Emitters, Tubing, Multi-Port Emitters, IH Risers, MLD, Eco-Indicator***, Multi-Purpose Box, Senninger Regulators, PLD-LOC Fittings
	VALVES	PGV	TOOLS	SpotShot
	CENTRAL****	All central communication modules (cell, LAN, Wi-Fi and automation field servers)		
THREE YEARS	CONTROLLERS	ROAM XL, EZ Decoder System, EZ-DT	MP ROTATOR	All
	ROTORS	PGP Ultra, I-20, I-25, I-40, I-80, and I-90	CONTROLLERS	ACC2, ICC2, ICD Decoders, ICD-HP Programmer
FIVE YEARS	SPRAYS	Pro-Spray, Pro-Spray PRS30, and Pro-Spray PRS40	SENSORS	Clik Sensors, Flow-Sync, MWS, Solar Sync, Wireless Flow Sensor
	VALVES	HQ, ICV, IBV	MICRO	ICZ, IBZ, HDL**, HDL-COP**, Eco-Mat, Eco-Wrap, Eco-Indicator***

Hunter Golf and ST System Irrigation Products*

Hunter will repair, replace, or repurchase, at its sole discretion, any defective component* assemblies contained within the Golf and ST products listed below by category, returned freight prepaid, from the date of manufacture within a period of:

ONE YEAR	GOLF CONTROLLERS	Pilot Command Center Software, Pilot-FC, Pilot-FI, Pilot Hub
THREE YEARS	GOLF ROTORS	TTS-800 Series, G-800 Series, G-900 Series, B-Series
	GOLF TWO-WAY MODULES	Pilot 100, Pilot 200, Pilot 400, Pilot 600
FIVE YEARS	GOLF ROTORS	The golf rotor component warranty is extended to 5 years with a one-for-one purchase of an HSJ Swing Joint from an authorized Hunter Golf distributor.
	SWING JOINTS	HSJ-0, HSJ-1, HSJ-2, HSJ-3
	ST ROTORS	ST-90, STG-900, ST-1200, ST-1600
	ST ACCESSORIES	All models starting with “ST”
	COMPUTER, PRINTERS & ACCESSORIES, MAINTENANCE RADIO & BATTERY	Equipment manufacturer’s warranty (no Hunter warranty)



Built on Innovation®

* Warranty covers repair, replacement, or repurchase of individual defective component assemblies contained within the product. Returns of complete finished goods are not allowed under warranty without prior approval from the Hunter Product Manager.

If used for agricultural applications, Hunter limits the warranty for valves, sprays, MP Rotator Nozzles, and rotor products to a period of one (1) year from the original date of manufacture. This agriculture limitation supersedes all other warranties expressed or implied.

** Plus 2 additional years for environmental stress cracking. No warranty against root intrusion on HDL-COP. While the use of copper does not completely remove the chance of root intrusion, it has been shown to assist in its prevention when coupled with proper irrigation scheduling.

*** Eco-Indicator – 6" ECO-ID: 2-year warranty; 12" ECO-ID-12: 5-year warranty

**** Hunter's cellular module warranty does not apply to the availability or compatibility of cellular data service, in any particular area. Availability of compatible data services should be determined prior to installation.

Statement of Warranty, Continued

If a defect in a Hunter product is discovered during the applicable warranty period, Hunter will repair or replace, at its option, the product or the defective part. This warranty does not extend to repairs, adjustments, or replacement of a Hunter product or part that results from misuse, negligence, alteration, modification, tampering, or improper installation and/or maintenance of the product. This warranty extends only to the original installer of the Hunter product. If a defect arises in a Hunter product during the warranty period, contact your local Hunter Authorized Distributor.

Hunter's warranty applies only to products installed as specified and used as intended for irrigation purposes. Hunter's warranty shall be limited to defects in materials and workmanship during the warranty period, and shall not extend to situations in which the product was subjected to improper design, installation, operation, maintenance, application, abuse, improper electrical current, grounding, service other than by Hunter authorized agents, operating conditions other than that for which it was designed, or in systems using water containing corrosive chemicals, electrolytes, sand, dirt, silt, rust, or agents that otherwise attack and degrade plastics. Hunter's warranty does not cover component failures caused by lightning strikes, electrical power surges, or unconditioned power supplies. If products are repurchased, the price to Distributor for such products in effect at the time of return will apply.

Hunter's obligation to repair, replace, or repurchase its products or product components as set forth above is the sole and exclusive warranty extended by Hunter. There are no other warranties, expressed or implied, including warranties of merchantability and warranties of fitness for a particular purpose. Hunter will not be liable to a distributor or to any other party in strict liability, tort, contract, or any other manner for any damages caused or claimed to be caused as a result of any design of or defect in Hunter's products, or for any special, incidental, or consequential damages of any nature.

Where applicable, Hunter's statement of warranty complies with local directives.

If you have any questions concerning the warranty or its application, please email support@hunterindustries.com.

ASAE CERTIFICATION STATEMENT

Hunter Industries Incorporated certifies that pressure, flow rate, and radius data for these products were determined and listed in accordance with ASAE Standard S398.1, Procedure for Sprinkler Testing and Performance Reporting, and are representative of performance of production sprinklers at the time of publication. Actual product performance may differ from the published specifications due to normal manufacturing variations and sample selection. All other specifications are solely the recommendation of Hunter Industries Incorporated.



Helping our customers succeed is what drives us. While our passion for innovation and engineering is built into everything we do, it is our commitment to exceptional support that we hope will keep you in the Hunter family of customers for years to come.

Gregory R. Hunter, CEO of Hunter Industries

Denise Mullikin, President, Landscape Irrigation and Outdoor Lighting

Website hunterindustries.com | **Customer Support** 1-800-383-4747 | **Technical Service** 1-800-733-2823

USA HEADQUARTERS

1940 Diamond Street
San Marcos, CA 92078 USA
TEL: 1-760-744-5240

MEXICO

ISO 9001:2015 Certified
Calle Nordika #8615
Colonia la Joya
Parque Industrial Nordika
Tijuana, B.C., Mexico CP 22640
TEL: +011-52-664-903-1382

EUROPE

Avenida Diagonal 523, 5o-2a
Edificio Atalaya
08029 Barcelona, Spain
TEL: +34-9-34-94-88-81

AUSTRALIA

50 Lynch Street
Hawthorn, VIC 3122, Australia
TEL: +1-800-438-486 [1-800-GETHUNTER]
(in Australia)
TEL: +61-3-9562-9918 (outside Australia)

MIDDLE EAST

P.O. Box 2370
Amman, 11941, Jordan
TEL: +962-6-5152882
FAX: +962-6-5152992

CHINA

B1618, Huibin Plaza
No. 8, Beichen Dong Street
Beijing 100101, China
TEL/FAX: +86-10-84975146